

Stylmaster™ Incandescent Luminaires

Enclosed and Gasketed

Attractively styled fixture with prismatic globe. UNILETS® for use with threaded metal conduit.

NEC:
Class I, Division 2, Groups A, B, C, D

CSA: ^{UL}
Class I, Division 2, Groups A, B, C, D
Class II, Division 1 and 2, Groups E, F, G
Class III
Enclosure 4X

Applications

- Enclosed and gasketed lighting fixtures for use in storage areas, tunnels, subways, chemical plants and other areas where moisture, dirt or corrosive atmospheres are a problem.
- Suitable for use in wet locations.
- Standard fixtures designed for 60 to 300 Watt medium base incandescent lamps.
- Pendant, feed-thru, ceiling, stanchion and wall mounts available.
- Ventilated steel reflectors with white porcelain finish are available for standard applications. Fiberglass reinforced polyester reflectors are designed for installations where fixture is subject to severe corrosive conditions or vandalism.

Features

- Modern styling, with clean-line mounting hood and prismatic glass globe, plus optional guard.
- Prismatic globe, furnished as standard, eliminates glare and distributes light evenly.
- Globe seats firmly against composition gasket in mounting hood to keep out dirt and moisture. Full threads eliminate "cross threading."
- Fixture is complete with gaskets and socket. Socket is shock-absorbing to prolong lamp life and can be easily removed for wiring without tools.
- Porcelain socket construction assures long trouble-free operation in high ambient installations.
- Both porcelain steel and polyester reflectors are secured to mounting hoods with screws (furnished).
- Guards have exclusive snap-on attachment feature for quick installation and fast servicing.
- Choice of reflector styles:
(1) steel reflector with white porcelain enamel in standard dome and 30° angle
(2) fiberglass reinforced polyester reflector in standard dome and 30° angle.
- Maximum input voltage 277 V (suitable for DC applications).

Standard Materials

- Mounting hoods: copperfree (4/10 of 1% max.) aluminum
- Guards: pressure cast copperfree (4/10 of 1% max.) aluminum
- Reflectors: porcelain steel or fiberglass reinforced polyester
- Socket: porcelain with brass screw shell
- Globes: prismatic glass

Standard Finishes

- Mounting hoods and guards: epoxy powder coat
- Steel reflectors: baked white porcelain enamel
- Fiberglass reinforced polyester reflectors: natural finish
- Socket and globes: natural finish

Options

- To order fixture with other than standard clear glass globe, add suffix letters to catalog number as indicated in table, and adjust difference in price.

Color	Glass Globe	Plastic Globe
Amber	-AM	-PAM
Blue	-BL	-PBL
Green	-GR	-PGR
Red	-RE	-PRE
Clear Heat-Resistant	-HR	—

^{UL} CSA Certification only.



Illustrated Features



Mounting Hood

Pendant style shown has setscrew to prevent fixture stem from turning. Other styles include stanchion, ceiling and wall mounting.

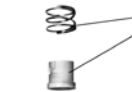

Shock-Absorbing Medium Base Socket

Spring absorbs vibration to prolong lamp life. Porcelain construction for trouble-free operation in high ambient installations.



Globe

Attractive, tapered prismatic glass globes for glare elimination and uniform light distribution. Colors available – also vandal-resistant plastic globes. Globe seats firmly against gasket to exclude moisture, dirt and vapors.

Guard

Snap-on guards (and reflectors) – simply snap-in and twist. Spring action balls snap into detents of fixture body.

Guard and Reflectors

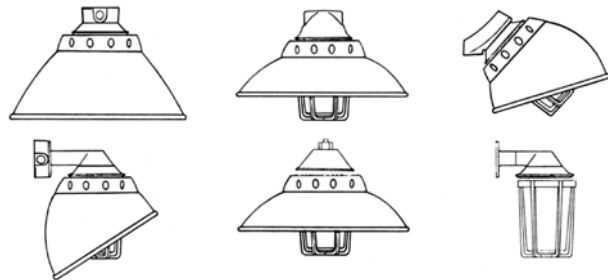

Certifications and Compliances

- UL Standard: UL 1598, UL 844
- UL Listed: E10444
- CSA Standard: C22.2 No. 250, C22.2 No. 137
- CSA Certified: 025428

Stylmaster™ Incandescent Luminaire Thermal Suitability

Enclosed and Gasketed

Attractively styled fixture with prismatic globe. UNILETS® for use with threaded metal conduit.

NEC:
Class I, Division 2, Groups A, B, C, D

CSA: ¹
Class I, Division 2, Groups A, B, C, D
Class II, Division 1 and 2, Groups E, F, G
Class III
Enclosure 4X

Class I, Division 2, Groups A, B, C, D

Fixture is suitable for Class I, Division 2 where the fixture operating temperature does not exceed the ignition temperature of the atmosphere in which fixture is installed.

“T” Numbers Represent the Maximum Lamp Temperature for Class I, Division 2 Locations

Supply Wire: 392 °F/200 °C

“T” Number	T1	350	325	T2	T2A	T2B	T2C	T2D	T3	T3A	T3B	T3C	T4	T4A	T5	T6
Temp. Range (°F)	664-842	619-662	574-617	538-572	502-536	448-500	421-446	394-419	358-392	331-356	322-329	277-320	250-275	214-248	187-212	185
Temp. Range (°C)	351-450	326-350	301-325	281-300	261-280	231-260	216-230	201-215	181-200	166-180	161-165	136-160	121-135	101-120	86-100	85

Class I, Division 2, Groups A, B, C, D

Reflector	VPGL-1HR (60-200 W)				VPGL-2HR (200-300 W)			
	A-21 100 W	A-21 150 W	A-23 200 W	A-23 200 W	PS-25 200 W	PS-30 200 W	PS-25 300 W	PS-30 300 W
None	T3	T2D	T2C	T2C	T2C	T2C	325	325
Standard Dome	T2D	T2D	T2B	T2B	T2B	T2C	325	325
30° Angle	T2D	T2C	T2B	T2B	T2B	T2B	325	325

Fixture Ambient Suitability:

Areas	°F	°C
Non-Classified	392	200
Classified	104	40

Fixture Ambient Suitability:

Class II, Groups E, F, G; Class III; Enclosure 4X

Fixture	Watts
A-23	60 to 300
PS-30	60 to 300

LIGHTING: ENCLOSED AND GASKETED – AREA – INCANDESCENT

Lighting

¹ CSA Certification only.









Stylmaster™ Incandescent Luminaires

Enclosed and Gasketed

Attractively styled fixture with prismatic globe. UNILETS® for use with threaded metal conduit.

NEC:
Class I, Division 2, Groups A, B, C, D

CSA: ^{UL}
Class I, Division 2, Groups A, B, C, D
Class II, Division 1 and 2, Groups E, F, G
Class III
Enclosure 4X

Without Guard	With Guard	Type	Lamp Watts	Hub Size (Inches)	NEC Catalog Numbers		CSA Catalog Numbers ^{UL}	
					With Globe and Guard	With Globe Only	With Globe and Guard	With Globe Only
Pendant — 3/4" tapped opening — Furnished with 3/4" to 1/2" reducer								
		A-23	60-200	1/2 or 3/4	VPA1075G	VPA1075	VCA1075G	VCA1075
		PS-30	200-300	1/2 or 3/4	VPA2075G	VPA2075	VCA2075G	VCA2075
Ceiling — Five Tapped Openings — With mounting lugs and four close-up plugs								
		A-23	60-200	1/2 3/4	VPX1050G VPX1075G	VPX1050 VPX1075	— VCX1075G	— VCX1075
		PS-30	200-300	1/2 3/4	VPX2050G VPX2075G	VPX2050 VPX2075	— VCX2075G	— VCX2075
Ceiling — Outlet Box Mounting — Fits SEH ① or VPJB cast outlet box, or 4" octagonal outlet box — Furnished with screws and gasket — Octagonal outlet boxes for non-classified areas only								
		A-23	60-200	3/4	VPOB10G	VPOB10	VCOB10G	VCOB10
		PS-30	200-300	3/4	VPOB20G	VPOB20	VCOB20G	VCOB20
45° Stanchion — 1-1/4" Conduit								
		A-23	60-200	1-1/4	VPAN10125G	VPAN10125	VCAN10125G	VCAN10125
		PS-30	200-300	1-1/4	VPAN20125G	VPAN20125	VCAN20125G	VCAN20125

LIGHTING: ENCLOSED AND GASKETED — AREA — INCANDESCENT

Lighting

① Order SEH box from catalog Fittings Section, 4" octagonal steel boxes from the Commercial Products Section and VPJB cast box from this Section.

^{UL} CSA Certification only.

Stylmaster™ Incandescent Luminaire Dimensions

Enclosed and Gasketed

Attractively styled fixture with prismatic globe. UNILETS® for use with threaded metal conduit.

Pendant Mount ❶

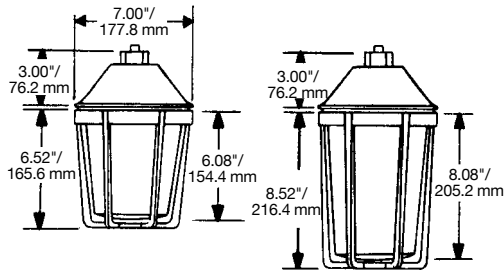

45° Stanchion Mount ❷

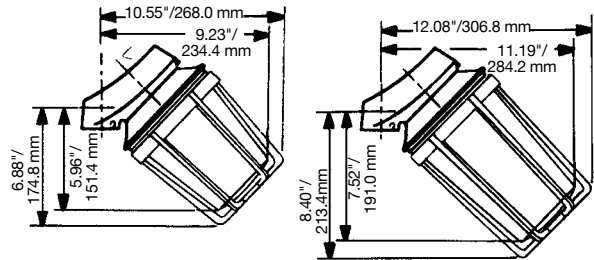

Ceiling Outlet Box Mount

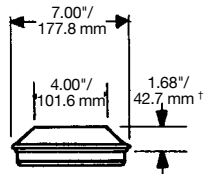

Ceiling Mount for Junction Box

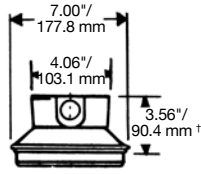

Wall Mount with Junction Box

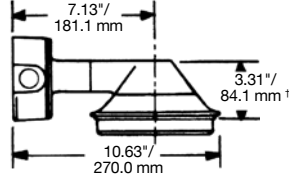

Wall Outlet Box Mount

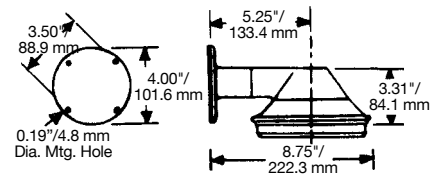

Junction Box Mounting Body

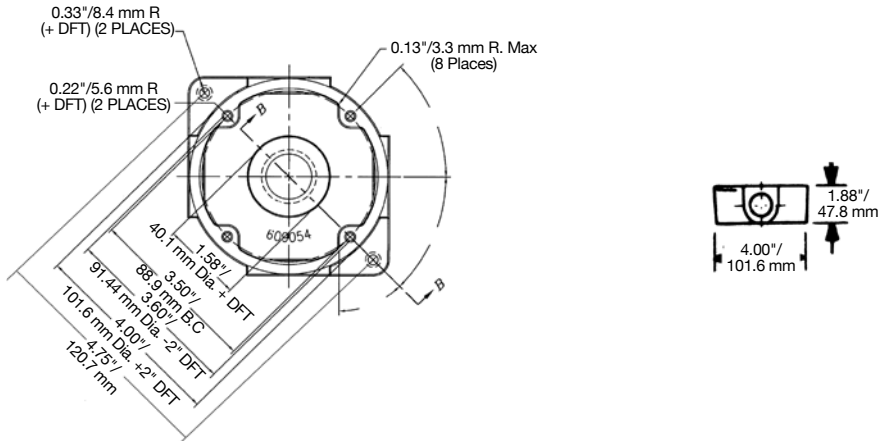

❶ Height of hood is measured to bottom of flange. Height of globe and guard is from bottom of flange.
 ❷ Dimensions of angle are from center of pipe. Height is measured from pipe stop in stanchion hood.