

Fluke 434-II/435-II/437-II
Three Phase Energy and Power Quality Analyzer

Service Manual

PN 4822 872 05408

Febr. 2013

© 2013 Fluke Corporation, All rights reserved.

All product names are trademarks of their respective companies.

Table of Contents

Chapter	Title	Page
	Safety Instructions	1-1
1.1	Introduction.....	1-3
1.2	Safety Precautions.....	1-3
1.3	Caution and Warning Statements	1-3
1.4	Symbols	1-3
1.5	Impaired Safety.....	1-4
1.6	General Safety Information	1-4
1.7	Safe Handling and Use of Li-ion battery pack	1-4
	Characteristics.....	2-1
2.1	Introduction.....	2-3
	List of Replaceable Parts	3-1
3.1	Introduction.....	3-3
3.2	How to Obtain Parts.....	3-3
3.3	Service Centers	3-3
3.4	Final Assembly Parts	3-4
3.5	Accessories	3-7
	Performance Verification	4-1
4.1	Introduction.....	4-3
4.2	Equipment Required for Verification	4-4
4.3	Relation between Characteristics and Performance Test.....	4-4
4.4	General Instructions	4-5
4.5	Operating Instructions.....	4-5
	Resetting the Analyzer	4-5
4.6	Display and Backlight Test.....	4-5
4.7	Verification of Current Inputs.....	4-5
	4.7.1 Preparation.....	4-5
	4.7.2 Accuracy.....	4-6
	4.7.3 Bandwidth check of current channels (*).....	4-7
4.8	Voltage Inputs.....	4-8
	4.8.1 Introduction	4-8
	4.8.2 Verification of voltage inputs in 120 V range	4-9
	4.8.3 Verification of voltage inputs in 230 V range	4-11
	4.8.4 Verification of voltage inputs in 400 V range	4-13
	4.8.5 Verification of voltage inputs in 6 kV range (Transients).....	4-15
4.9	Channel Isolation (*)	4-17

Calibration Adjustment.....	5-1
5.1 General.....	5-3
5.1.1 Introduction	5-3
5.1.2 Calibration number and date	5-3
5.1.3 General instructions.....	5-3
5.1.4 Equipment required for calibration	5-4
5.2 Calibration Procedure Steps.....	5-4
5.3 Starting The Calibration.....	5-4
5.4 Contrast Calibration Adjustment	5-6
5.5 Warming Up	5-7
5.6 Final Calibration	5-8
5.6.1 Warming Up Final.....	5-8
5.6.2 Offset adjustment.....	5-8
5.6.3 Low voltage and current gain adjustment	5-10
5.6.4 Current gain 10x.....	5-10
5.6.5 Voltage gain adjustment	5-10
5.7 Save Calibration Data And Exit.....	5-12
Disassembling the Analyzer	6-1
6.1. Introduction.....	6-3
6.2. Disassembly & Reassembly Procedures.....	6-3
6.2.1 Required Tools	6-3
6.2.2 Removing the Tilt Stand, Hang Strap, and Side Strap	6-4
6.2.3 Opening the Analyzer, Removing the Battery Pack.....	6-4
6.2.4 Getting access to Top Side of PCA	6-5
6.2.5 Getting access to Bottom Side of PCA.....	6-5
6.2.6 Getting access to LCD, Keypad Foil and Keypad.....	6-5
6.2.7 Pictures Showing Disassembly Steps	6-6

Chapter 1

Safety Instructions

Title	Page
1.1 Introduction.....	1-3
1.2 Safety Precautions.....	1-3
1.3 Caution and Warning Statements	1-3
1.4 Symbols	1-3
1.5 Impaired Safety.....	1-4
1.6 General Safety Information	1-4
1.7 Safe Handling and Use of Li-ion battery pack	1-4

1.1 Introduction

Read these pages carefully before beginning to install and use the Analyzer.

The following paragraphs contain information, cautions and warnings which must be followed to ensure safe operation and to keep the Analyzer in a safe condition.

Warning

Servicing described in this manual is to be done only by qualified service personnel. To avoid electrical shock, do not service the Analyzer unless you are qualified to do so.

1.2 Safety Precautions

For the correct and safe use of this Analyzer it is essential that both operating and service personnel follow generally accepted safety procedures in addition to the safety precautions specified in this manual. Specific warning and caution statements, where they apply, will be found throughout the manual. Where necessary, the warning and caution statements and/or symbols are marked on the Analyzer.

1.3 Caution and Warning Statements

Caution









Used to indicate correct operating or maintenance procedures to prevent damage to or destruction of the equipment or other property.







Warning

Calls attention to a potential danger that requires correct procedures or practices to prevent personal injury.

1.4 Symbols

The following symbols are used on the Analyzer, in the Users Manual, in this Service publication, or on spare parts for this Analyzer.

	See explanation in Users Manual		DOUBLE INSULATION (Protection Class)
	Live voltage		Earth Ground
	Static sensitive components (black/yellow).	 Ni MH	Recycling information
	Do not dispose of this product as unsorted municipal waste. Go to Fluke's website for recycling information		Conformité Européenne

 <p>Battery Safety Approval</p>	 <p>Conforms to relevant Australian standards</p>
 <p>Safety Approval</p>	 <p>Safety Approval</p>
 <p>RoHS China</p>	 <p>Current Clamp</p>

1.5 Impaired Safety

Whenever it is likely that safety has been impaired, the Analyzer must be turned off and disconnected from line power. The matter should then be referred to qualified technicians. Safety is likely to be impaired if, for example, the Analyzer fails to perform the intended measurements or shows visible damage.

1.6 General Safety Information

Warning

Removing the Analyzer covers or removing parts, except those to which access can be gained by hand, is likely to expose live parts and accessible terminals which can be dangerous to life.

The Analyzer shall be disconnected from all voltage sources before it is opened.

Capacitors inside the Analyzer can hold their charge even if the Analyzer has been separated from all voltage sources.

When servicing the Analyzer, use only specified replacement parts.

1.7 Safe Handling and Use of Li-ion battery pack

The Analyzer uses a rechargeable Li-ion battery pack model BP290 (26 Wh, standard) or BP291 (52 Wh, optional).

For instructions how to safely handle and use this battery pack refer to Chapter 1, General Aspects, Paragraph ‘Safe Use of Li-ion Battery Pack’ in the Users Manual of Fluke 434-II/435-II/437-II.

The Users Manual can be downloaded from Fluke’s website.

Chapter 2

Characteristics

Title	Page
2.1 Introduction.....	2-3

2.1 Introduction

Performance Characteristics

For the specifications refer to the “Characteristics” Chapter 27 in the Fluke 434-II/435-II/437-II Users Manual.

The Users Manual can be downloaded from Fluke’s website.

Specifications are based on a one year calibration cycle.

Chapter 3

List of Replaceable Parts

Title	Page
3.1 Introduction.....	3-3
3.2 How to Obtain Parts.....	3-3
3.3 Service Centers	3-3
3.4 Final Assembly Parts	3-4
3.5 Accessories	3-7

3.1 Introduction

This chapter contains an illustrated list of replaceable parts for the models 434-II, 435-II, and 437-II Power Quality Analyzer Series II.

Parts are listed by assembly; alphabetized by item number or reference designator. Each assembly is accompanied by an illustration showing the location of each part and its item number or reference designator. The parts list gives the following information:

- Description
- Ordering code



Caution

Electrical components and in particular active components such as IC's, transistors and diodes may be damaged by static discharge.

Handling and servicing static sensitive components and assemblies should be done only at a static free workstation by qualified personnel.

3.2 How to Obtain Parts

In the event that the part ordered has been replaced by a new or improved part, the replacement will be accompanied by an explanatory note and installation instructions, if necessary.

To ensure prompt delivery of the correct part, include the following information when you place an order:

- Instrument model (for example Fluke 435-II), 12 digit instrument code (9444), and serial number (15500001). The items are printed on the type plate on the bottom cover.
- Ordering code
- Description
- Quantity

3.3 Service Centers

To locate an authorized service center, call Fluke using any of the phone numbers listed below, or visit on the World Wide Web: www.fluke.com

USA and Canada: 1-888-99-FLUKE (1-888-993-5853)

Europe: +31-40-2675200

Anywhere in the world: +1-425-446-5500

3.4 Final Assembly Parts

See Table below. In Chapter 6 – Disassembling the Analyzer, pictures are present giving an impression on how the instrument is constructed.

Dedicated pictures with item numbers are scheduled for a future revision of this Service Information.

Table 3-1. Final Assembly Parts and Kits

Part or Kit	Ordering Code	Consists of Following Parts	Figure/Item nr
Case Set 43x-II	4161577	Front case (excl. lens/decal)	3-2/21
		Inner lens (for double isolation)	---
		Dustseal long (2x, around screen)	---
		Dustseal short (2x, around screen)	---
		Case seal (white)	3-2/27
		Bottom case assy	3-1/3
		Battery door	3-1/16
		Adhesive foam (for battery door)	---
		Quarter turn screw (2x)	---
		Standup bracket	3-1/18
Quarter turn screw	948609	For battery door (1x)	---
Decal Set for Input Sockets, Colored	4137197	Supplied with Analyzer as standard accessory	---
Decal Set for Input Sockets, Black & White	4137201	Stuck on Analyzer at delivery	---
Li-ion Battery Pack	BP290 (standard)	26 Wh, 10.8 V	3-1/17
Li-ion Battery Pack	BP291 (optional)	52 Wh, 10.8 V	3-1/17
Lens/decal 434-II	4161589	---	---
Lens/decal 435-II	4161592	---	---
Lens/decal 437-II	4161605	---	---
LCD assy Flk 43x-II and Flk-190-II	3981844	LCD module LCD fixation foam Flat cable	3-2/23
Topholster 43x-II (Input Cover)	4161610	Excluding decals	3-1/1
Mounting Material Set 43x-II	4161622	Selftapping screw black (2 pcs/instr, to fix topolster)	3-1/2
		Dowel (6 pcs/instr, to fix side strap + hang strap)	3-1/5
		Steel plate for Kensington lock (1 pce/instr)	3-1/9
		Selftapping screw blank (6 pcs/instr, to fix bottom case and battery door detection)	3-1/4 3-1/8
		Screw M3x6 (2 pcs/instr, to fix bottom holster)	3-1/12
		Square nut M3 (2 pcs/instr, to fix bottom holster)	3-1/12
		Selftapping screw blank (6 pcs/instr, to fix Main PCA module to Front)	3-2/22

Part or Kit	Ordering Code	Consists of Following Parts	Figure/Item nr
		Case)	
Side Strap	3945370	Can be fixed on Left or Right side	---
Hang Strap	946769	Can be fixed op Top Side of Instrument	---
Bottom Holster Set 43x-II	4161646	Bottom Holster assy	3-1/7
		Cover for USB, yellow/black	3-1/10
		Cover for right side, yellow	3-1/11
Connector Set 43x-II	4161654	Mini USB connector J1300	---
		Faston pin to battery (5 pcs/instr)	---
		Cushion (Fits around faston pin)	---
		Sealing piece USB, black (1 pce/instr)	3-2/25
		Sealing piece, right side, black(1 pce/instr)	3-2/24
		Battery Door Detection (opto device)	3-1/6
		Power Connector DC	---
		Keyboard connector 24p J1000	---
		LCD connector 20p J1201	---
		LCD backlight conn 4p J1200	---
Keypad 43x-II	4161679	---	3-2/26
Keypad Foil 43x-II	4161687	(Incl. Flat Cable)	3-2/20
Cable DB-9 to Mini-USB	4161693	For use of GPS 430 option with Flk 43x-II	---
Input Socket Block 43x-II	4161668	BNC black (4 pcs/instr)	3-1/14
		Banana jack black (4 pcs/instr)	---
		Banana jack green (1 pce/instr)	---
		O-ring 11x1 mm	---
		O-ring 12x2 mm	---
		Sealing strip, flexible, fits around inputs	3-1/13

Note



The Analyzer contains a Li-ion battery. Do not mix with the solid wastestream. Spent batteries should be disposed of by a qualified recycler or hazardous materials handler.

Figure 3-1. Parts and kits 1.

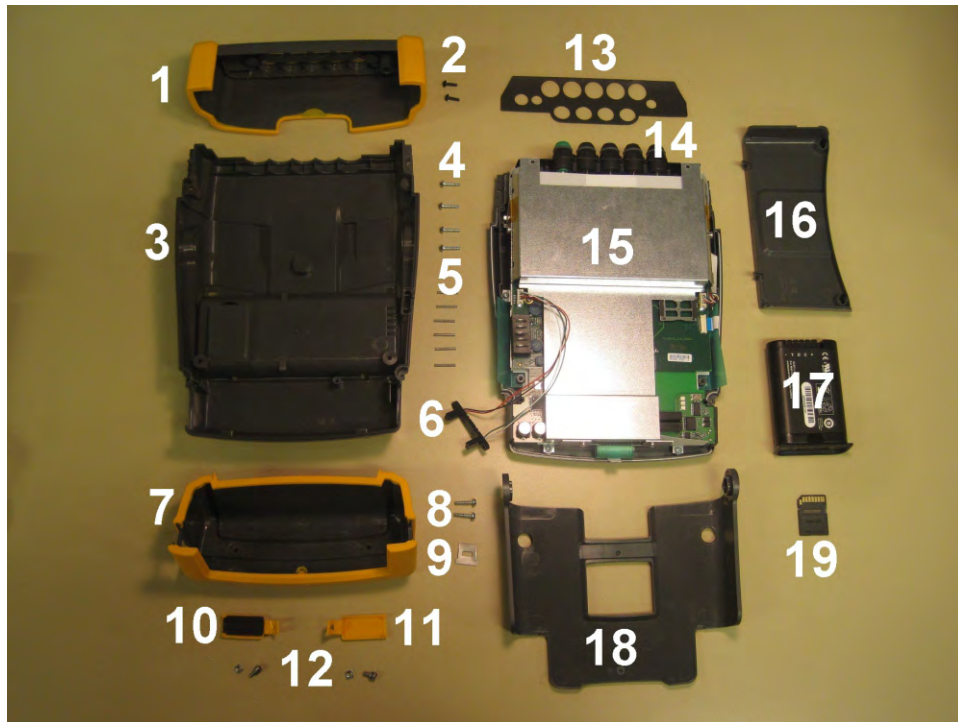
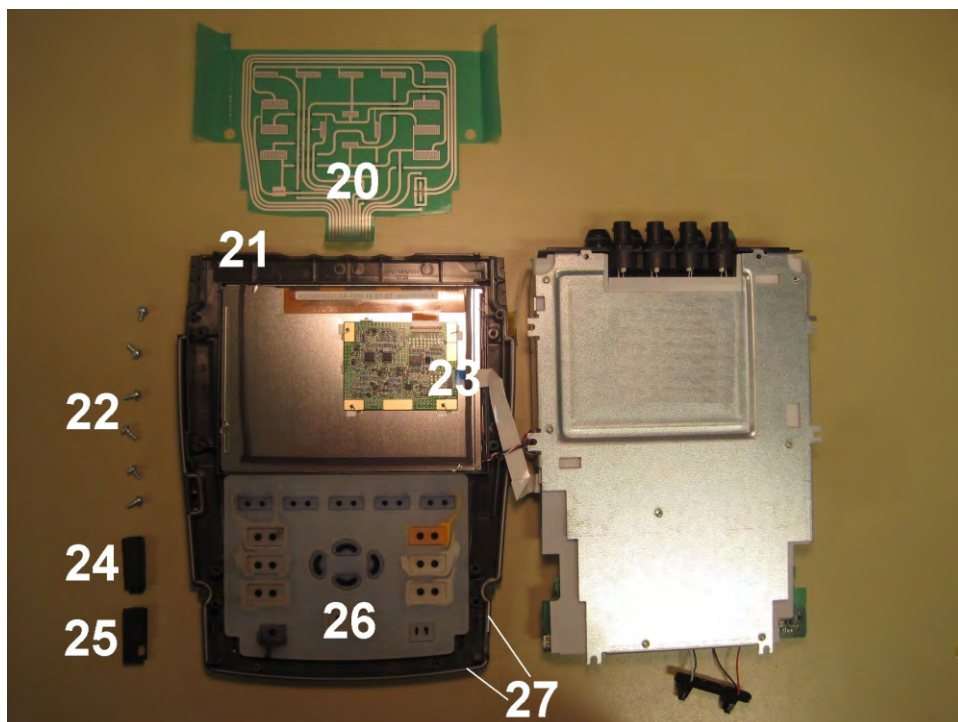

Figure 3-2. Parts and kits 2.



3.5 Accessories

Refer to the Fluke 434-II/435-II/437-II Users Manual, Chapter 26 – Tips and Maintenance, for a list with standard and optional accessories.

The Users Manual can be downloaded from the Fluke website.

Chapter 4

Performance Verification

Title	Page
4.1 Introduction.....	4-3
4.2 Equipment Required for Verification	4-4
4.3 Relation between Characteristics and Performance Test.....	4-4
4.4 General Instructions	4-5
4.5 Operating Instructions.....	4-5
Resetting the Analyzer	4-5
4.6 Display and Backlight Test.....	4-5
4.7. Verification of Current Inputs.....	4-5
4.7.1 Preparation.....	4-5
4.7.2 Accuracy.....	4-6
4.7.3 Bandwidth check of current channels (*).....	4-7
4.8 Voltage Inputs.....	4-8
4.8.1 Introduction	4-8
4.8.2 Verification of voltage inputs in 120 V range	4-9
4.8.3 Verification of voltage inputs in 230 V range	4-11
4.8.4 Verification of voltage inputs in 400 V range	4-13
4.8.5 Verification of voltage inputs in 6 kV range (Transients).....	4-15
4.9 Channel Isolation (*)	4-17

4.1 Introduction

Warning

Procedures in this chapter should be performed by qualified service personnel only. To avoid electrical shock, do not perform any servicing unless you are qualified to do so.

The Fluke 434-II/435-II/437-II Three Phase Energy & Power Quality Analyzer (referred to as Analyzer) should be calibrated and in operating condition when you receive it.

The following performance tests are provided to ensure that the Analyzer is in a proper operating condition. If the Analyzer fails any of the performance tests, calibration adjustment (see Chapter 5) and/or repair in a Fluke Service Center is necessary.

The Performance Verification Procedure is based on the specifications, listed in the “Characteristics” Chapter 26 in the Fluke 434-II/435-II/437-II Users Manual. The Users Manual can be downloaded from Fluke’s website. Specifications are based on a one year calibration cycle.

The values given here are valid for ambient temperatures between 15 °C and 35 °C.

Analyzer performance can be checked with single phase 50 and 60 Hz test signals such as generated by a Calibrator Fluke 5700A.

The tests mainly verify accuracy and offset of voltage and current inputs.

Tests indicated with (*) are optional. They can be done to check if the Analyzer’s hardware (analog input channels) is OK. Bear in mind that the outcome of these checks is rather influenced by hardware sanity than by Calibration Adjustment.

Accuracy of all other Analyzer functions is linked to input accuracy and is embedded in the Analyzer’s software. This link is tested extensively for each new software release. This testing is done with the **Fluke 6100A Electrical Power Standard** and 6101A Auxiliary units. This setup allows multiphase operation and direct testing of measuring functions such as flicker, harmonics, interharmonics, fluctuating harmonics, dips & swells, unbalance and also compounds of these disturbances.

Fluke 6100A and 6101A are recommended for those who want to test all measuring functions of Fluke 434-II/435-II/437-II.

Tests are done in V/A/Hz mode (unless indicated otherwise).

All indicated voltages and currents are rms values.

The Performance Verification Procedure is a quick way to check most of the Analyzer’s specifications. Because of the highly integrated design of the Analyzer, it is not always necessary to check all features separately.

Always put the Analyzer in STBY (Stand By) mode before changing test leads. Fluke 5700A has a toggle key OPR/STBY with function indication in the display.

Important: during all tests, signal must be applied to voltage channel A/L1. A/L1 is the reference channel.

The verification procedure assumes that the test engineer is familiar with the operation of Analyzer and Calibrator.

4.2 Equipment Required for Verification

The primary source instrument used in the verification procedures of Fluke 434-II/435-II/437-II is the Fluke 5700A. If not available, you can substitute another Calibrator as long as it meets the minimum test requirements.

- Fluke 5700A Calibrator.
- Test Leads (4x), as supplied with the Calibrator.
- Extra set of test leads capable to withstand 1000 V rms.
Note: for good recognition it is recommended to use a black lead between the Calibrator's LO and the Analyzer's Ground banana input.
- 50Ω Coax Cables (3 pieces required), Fluke PM9092 (0.5m, set of 3).
- Male BNC to Dual Female BNC adapter (3 pieces required), Fluke PM9093.
- Dual Banana Jack to female to male BNC (1 piece required), Fluke PM9082.
- 50Ω feed through termination (4 pieces required): Fluke PM9585.
- Battery Charger as supplied with the Analyzer.

4.3 Relation between Characteristics and Performance Test.

Test limits used are based upon the specifications in the Analyzer's Users Manual. This manual can be downloaded from www.fluke.com.

Accuracy requirements are as follows:

- Accuracy of current channels (Arms AC+DC):
0.5% of measurement \pm 5 counts.
Note: 5 counts equals 5 A @ Amps Scaling x1 AC+DC; 5 counts equals 0.5 A @ Amps Scaling x10 AC only.
- Accuracy of voltage channels Fluke 434-II (Vrms AC+DC):
0.5% of nominal voltage Vnom as adjusted under SETUP, Vnom (120 V, 230 V, or 400 V) @ input voltage range 1 ... 1000 Vrms.
- Accuracy of voltage channels Fluke 435-II/437-II (Vrms AC+DC):
0.1% of nominal voltage Vnom as adjusted under SETUP, Vnom (120 V, 230 V, or 400 V) @ input voltage range 1 ... 600 Vrms.
Input voltage range 600 ... 1000 Vrms: accuracy 0.1% of reading.
- Accuracy of voltage channels 6 kV (Transient capture rms reading):
2.5% of nominal voltage Vnom (e.g. 400 V).
- Bandwidth of current channels (Arms, Absolute):
5% of measurement \pm 5 counts.
Note: Bandwidth measurement is based on the accuracy of the harmonics mode. The Analyzer can measure harmonics up to the 50th. A nominal fundamental frequency of 60 Hz requires a bandwidth of $50 \times 60 = 3000$ Hz.
Note: 5 counts equals 5 A @ Amps Scaling x1 AC+DC; 5 counts equals 0.5 A @ Amps Scaling x10 AC only.
- Bandwidth of voltage channels (Vrms, Absolute):
434-II/435-II/437-II: 5% of measurement (if applied voltage is ≥ 1 % of nominal voltage).
Note: Bandwidth measurement is based on the accuracy of the harmonics mode. The Analyzer can measure harmonics up to the 50th. A nominal fundamental frequency of 60 Hz requires a bandwidth of $50 \times 60 = 3000$ Hz.
- Channel Isolation (Cross talk, Voltage to current input, x1, AC+DC):
Cross Talk from voltage into current channels: - 95 dB (= 56,234 times).

4.4 General Instructions







Follow these general instructions for all tests:

- It is recommended to remove the SD memory card from the Analyzer during the performance test to avoid that measuring data is written on it during the test. The SD card is located behind the battery door.
- For all tests, power the Analyzer with its power adapter. The battery pack must be installed and charged sufficiently.
- Allow the Calibrator to satisfy its specified warm-up period.
- For each test point, wait for the Calibrator to settle.
- Allow the Analyzer a minimum of 30 minutes to warm up.
- One division on the LCD consists of 25 pixels (1 pixel = 0.04 division).

4.5 Operating Instructions



Resetting the Analyzer

Proceed as follows:

- Press  to turn the Analyzer off.
- Press and hold .
- Press and release  to turn the Analyzer on.
- Wait until the Analyzer has **beeped twice**, and then release . When the Analyzer has beeped twice, the RESET was successful. This reset is used as start condition for the tests.
- If the SD card has been removed, press  - CLOSE.
- Next press  - CANCEL.

4.6 Display and Backlight Test



Proceed as follows to test the display and the backlight:

1. Press  to turn the Analyzer on. Press  - CLOSE and  to remove the Language selection screen.
2. Disconnect the Power Adapter, and verify that the backlight is dimmed.
3. Connect the Power Adapter and verify that the backlight brightness increases.

4.7. Verification of Current Inputs

4.7.1 Preparation

Proceed as follows:

- Reset the Analyzer and press  - CANCEL.
- Press . Then press F4 – MANUAL SETUP and use arrow keys and ENTER key to set the Analyzer to 3-phase WYE, 60 Hz, 120 V.

Set Clamp for Phase and Neutral (select with F4) to 1 mV/A, 1000 A, x1, 1:1. To confirm press F5 – BACK.

- Set the Analyzer in DEMO mode: press SETUP, press F1 - USER PREF, and select DEMO ON with F2. Demo mode gives increased sensitivity at the voltage inputs.
Warning: input voltage must not exceed 2 V rms in DEMO mode!

4.7.2 Accuracy

Proceed as follows:

1. Must be checked for all phases A/L1, B/L2, C/L3, and N(utral).
2. Set the Calibrator to 1 V, 60 Hz and STBY.
3. Connect the LO output (black) with the Ground (green) input of the Analyzer. Connect the HI output (red) with all current (BNC) inputs and the A/L1, B/L2, C/L3, and N voltage banana inputs of the Analyzer. Refer to Figure 4.2.

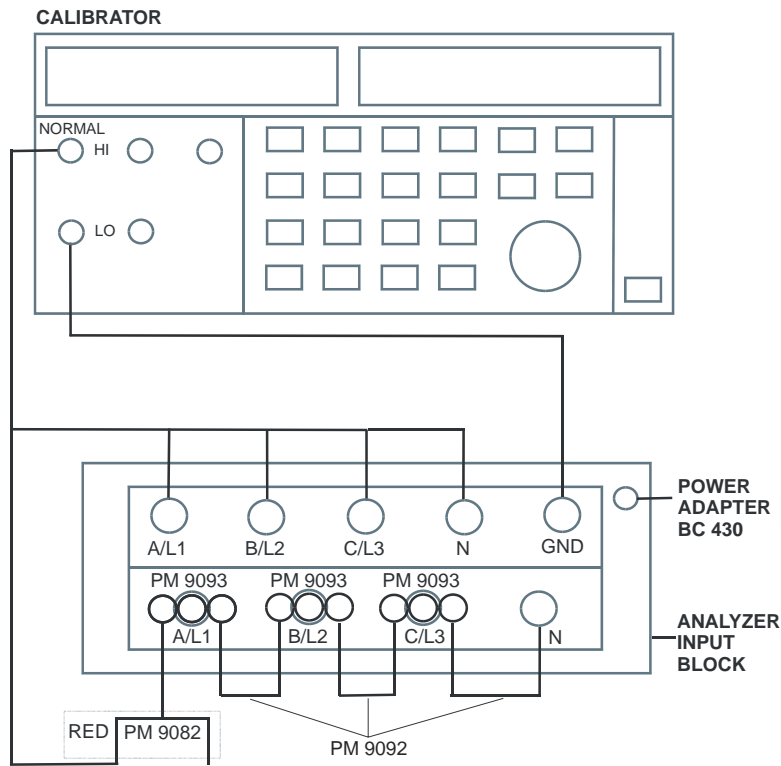

Figure 4-1. verification of Current Inputs

4. Set the Calibrator to OPR (Operate, indicated by a green LED in the OPR key or on the display).
5. On the Analyzer press MENU, select Volts/Amps/Hertz, press F5 – OK to enter the function.
6. Use the up/down arrow keys to get A rms readout in the screen area. Check for an A rms readout between 990 ... 1010 A (tolerance $5 + 5 A = 10 A$).
7. Set the Calibrator to 0 Hz, 0 V and then to OPR.
8. On the Analyzer check for a current readout A rms between 0 ... 5 A.

9. Press **SETUP**. Then press F4 – MANUAL SETUP and use arrow keys and ENTER key to set the Analyzer to Current Clamp sensitivity (Phase and Neutral: select with F4) to 1 mV/A, 100 A, x10 AC only, 1:1.
10. On the Analyzer press MENU, select Volts/Amps/Hertz, press F5 – OK to enter the function.
11. Set the Calibrator to 100 mV, 60 Hz and OPR.
12. Use the up/down arrow keys to get A rms readout in the screen area. Check for an A rms readout between 99.0 ... 101.0 A (tolerance 0.5 + 0.5 A = 1.0 A).

4.7.3 Bandwidth check of current channels (*)

Is an optional test. Proceed as follows:

1. Set the Calibrator to 100 mV, 60 Hz and OPR.
2. The current channels must be checked one by one. Use the Calibrator’s edit field function (AMPL/FREQ key) to adjust a readout of 1000 A for the current channel to be checked.
3. Increase the frequency to 3 kHz. Check for a readout of 94.5 A or more (table 4-1).

Table 4-1. Bandwidth Check of Current Channels (x10, AC only)

Current Channel to be verified	Readout at 60 Hz (adjust Calibrator with EDIT FIELD)	Readout at 3 kHz
A/L1	100.0 A	94.5 A or more
B/L2	100.0 A	94.5 A or more
C/L3	100.0 A	94.5 A or more
N	100.0 A	94.5 A or more

4. Set the Calibrator to STBY.
5. Press **SETUP**. Then press F4 – MANUAL SETUP and use arrow keys and ENTER key to set the Analyzer to Current Clamp sensitivity (Phase and Neutral: select with F4) to 1 mV/A, 1000 A, x1 AC + DC, 1:1.
6. The current channels must be checked one by one.
Set the Calibrator to 1 V, 60 Hz. Use the Calibrator’s edit field function (AMPL/FREQ key) to adjust a readout of 1000 A for the current channel to be checked.
7. Increase the frequency to 3 kHz. Check for a readout of 94.5 A or more (table 4-2).

Table 4-2. Bandwidth Check of Current Channels (x1, AC + DC)

Current Channel to be verified	Readout at 60 Hz (adjust Calibrator with EDIT FIELD)	Readout at 3 kHz
A/L1	1000 A	945 A or more
B/L2	1000 A	945 A or more
C/L3	1000 A	945 A or more
N	1000 A	945 A or more

8. Set the Calibrator to STBY.
9. Switch the Analyzer's DEMO mode to OFF.
10. Disconnect the leads from the current inputs.

4.8 Voltage Inputs

4.8.1 Introduction

WARNING

Dangerous voltages will be present on the calibration source and connecting cables during the following steps. Ensure that the Calibrator is in standby mode before making any connection between the Calibrator and the Analyzer.

Proceed as follows:

1. Press SETUP, press F1 - USER PREF, and select DEMO OFF with F2.
2. To check the A/L1, B/L2, C/L3 inputs, connect the N input to Ground (See Figure 4-3). N now will give zero reading.

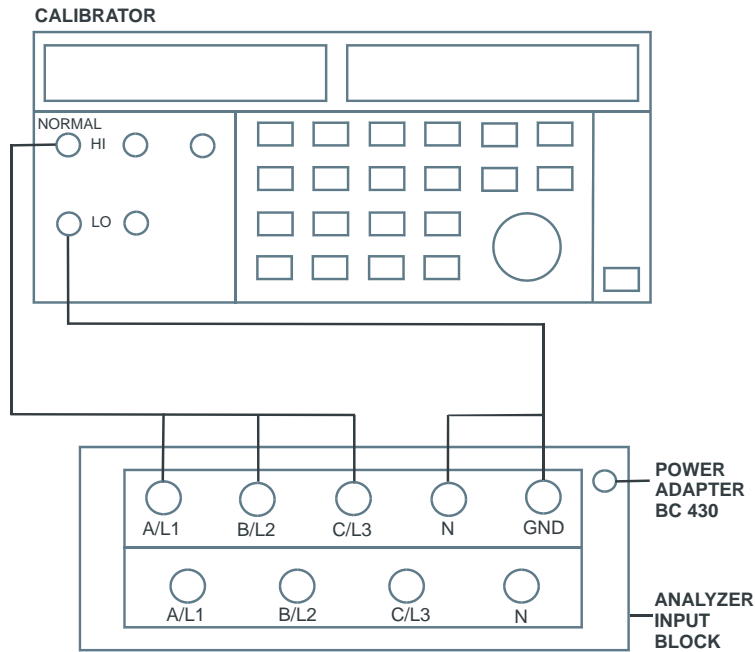

Figure 4-2. Checking the A/L1, B/L2, and C/L3 voltage inputs

3. To check the N input, connect the N input with the adjacent C/L3 input. A/L1, B/L2, C/L3 now will give zero reading. Refer to Figure 4-4.

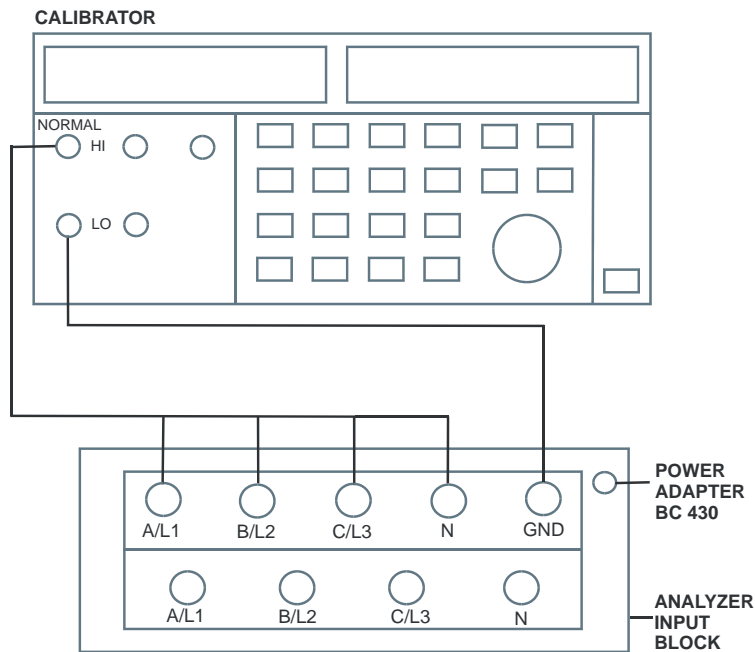

Figure 4-3. Checking the N (Neutral) voltage input

4.8.2 Verification of voltage inputs in 120 V range

Accuracy Check of Channel A/L1, B/L2, C/L3:

1. Set the Analyzer to 120 V, 60 Hz nominal (SETUP menu, arrow and ENTER keys). Press MENU, select Volts/Amps/Hertz, press F5 - OK.
2. To check the A/L1, B/L2, C/L3 inputs: connect the N input to Ground (See Figure 4-3).
3. Set the Calibrator to 60 Hz, 60 V and then to OPR.
4. Fluke 434-II: check for a voltage readout V rms between 59.4 ... 60.6 V.
Fluke 435-II/437-II: check for a voltage readout V rms between 59.88 ... 60.12 V.
5. Check the 120 V range according to the table below.

Table 4-3. Accuracy Check of Voltage Channels A/L1, B/L2, C/L3

Set Calibrator to	Readout at Voltage Channels
60 V, 60 Hz, OPR	Fluke 434-II: 59.4 ... 60.6 V Fluke 435-II /437-II: 59.88 ... 60.12 V
120 V, 60 Hz, OPR	Fluke 434-II: 119.4 ... 120.6 V Fluke 435-II /437-II: 119.88 ... 120.12 V
240 V, 60 Hz, OPR	Fluke 434-II: 239.4 ... 240.6 V Fluke 435-II /437-II: 239.88 ... 240.12 V

6. Set the Calibrator to STBY.

Optional Test. Bandwidth Check of Channel A/L1, B/L2, C/L3 (*):

7. Set the Calibrator to 120 V, 60 Hz and OPR.
8. Now check the voltage channels one by one. Use the Calibrator's field edit function (AMPL/FREQ key) to adjust the Calibrator to an Analyzer readout of 120.0 V / 120.00 V.
9. Increase the frequency to 3 kHz.
Fluke 434-II: check for a readout of 114.0 V or more.
Fluke 435-II/437-II: check for a readout of 114.00 V or more.
Check the channels according to the table below.

Table 4-4. Bandwidth Check of Voltage Channels A/L1, B/L2, C/L3

Voltage Channel to be verified	Readout at 60 Hz (adjust Calibrator with EDIT FIELD)	Readout at 3 kHz
A/L1	Fluke 434-II: 120.0 V Fluke 435-II /437-II: 120.00 V	Fluke 434-II: ≥ 114.0 V Fluke 435-II /437-II: ≥ 114.00 V
B/L2	Fluke 434-II: 120.0 V Fluke 435-II /437-II: 120.00 V	Fluke 434-II: ≥ 114.0 V Fluke 435-II /437-II: ≥ 114.00 V
C/L3	Fluke 434-II: 120.0 V Fluke 435-II /437-II: 120.00 V	Fluke 434-II: ≥ 114.0 V Fluke 435-II /437-II: ≥ 114.00 V

10. Set the Calibrator to STBY.

Accuracy Check of Channel N (Neutral):

11. Connect the N input with the C/L3 input (See Figure 4-4). A/L1, B/L2, C/L3 now give zero reading.
12. Set the Calibrator to 60 Hz / 60 V and then to OPR.
13. Fluke 434-II: check for a voltage readout V rms between 59.4 ... 60.6 V.
Fluke 435-II/437-II: check for a voltage readout V rms between 59.88 ... 60.12 V.
14. Check the 120 V range according to the table below.

Table 4-5. Accuracy Check of Voltage Channel N (Neutral)

Set Calibrator to	Readout at Voltage Channel N
60 V, 60 Hz, OPR	Fluke 434-II: 59.4 ... 60.6 V Fluke 435-II /437-II: 59.88 ... 60.12 V
120 V, 60 Hz, OPR	Fluke 434-II: 119.4 ... 120.6 V Fluke 435-II /437-II: 119.88 ... 120.12 V
240 V, 60 Hz, OPR	Fluke 434-II: 239.4 ... 240.6 V Fluke 435-II /437-II: 239.88 ... 240.12 V

15. Set the Calibrator to STBY.

Optional test. Bandwidth Check of Channel N (*):

16. Set the Calibrator to 120 V, 60 Hz and OPR.
17. Now check the voltage channel N. Use the Calibrator's field edit function (AMPL/FREQ key) to adjust the Calibrator to an Analyzer readout of 120.0 V / 120.00 V.
18. Increase the frequency to 3 kHz.
Fluke 434-II: check for a readout of 114.0 V or more.
Fluke 435-II/437-II: check for a readout of 114.00 V or more.
19. Set the Calibrator to STBY.

4.8.3 Verification of voltage inputs in 230 V range

Accuracy Check of Channel A/L1, B/L2, C/L3:

1. Set the Analyzer to 230 V, 50 Hz nominal (SETUP menu, arrow and ENTER keys). Press MENU, select Volts/Amps/Hertz, press F5 - OK.
2. To check the A/L1, B/L2, C/L3 inputs: connect the N input to Ground (See Figure 4-3).
3. Set the Calibrator to 50 Hz, 115 V and then to OPR.
4. Fluke 434-II: check for a voltage readout V rms between 113.8 ... 116.2 V.
Fluke 435-II/437-II: check for a voltage readout V rms between 114.77 ... 115.23 V.
5. Check the 230 V range according to the table below.

Table 4-6. Accuracy Check of Voltage Channels A/L1, B/L2, C/L3

Set Calibrator to	Readout at Voltage Channels
115 V, 50 Hz, OPR	Fluke 434-II: 113.8 ... 116.2 V Fluke 435-II /437-II: 114.77 ... 115.23 V
230 V, 50 Hz, OPR	Fluke 434-II: 228.8 ... 231.2 V Fluke 435-II /437-II: 229.77 ... 230.23 V
460 V, 50 Hz, OPR	Fluke 434-II: 458.8 ... 461.2 V Fluke 435-II /437-II: 459.77 ... 460.23

- Set the Calibrator to STBY.

Optional Test. Bandwidth Check of Channel A/L1, B/L2, C/L3 (*):

- Set the Calibrator to 215 V, 50 Hz and OPR
- Now check the voltage channels one by one. Use the Calibrator's field edit function (AMPL/FREQ key) to adjust the Calibrator to an Analyzer readout of 215.00 V
- Increase the frequency to 3 kHz.
Fluke 434-II: check for a readout of 204.2 V or more.
Fluke 435-II/437-II: check for a readout of 204.25 V or more.
Check the channels according to the table below.

Table 4-7. Bandwidth Check of Voltage Channels A/L1, B/L2, C/L3

Voltage Channel to be verified	Readout at 50 Hz (adjust Calibrator with EDIT FIELD)	Readout at 3 kHz
A/L1	Fluke 434-II: 215.0 V Fluke 435-II /437-II: 215.00 V	Fluke 434-II: ≥ 204.2 V Fluke 435-II /437-II: ≥ 204.25 V
B/L2	Fluke 434-II: 215.0 V Fluke 435-II /437-II: 215.00 V	Fluke 434-II: ≥ 204.2 V Fluke 435-II /437-II: ≥ 204.25 V
C/L3	Fluke 434-II: 215.0 V Fluke 435-II /437-II: 215.00 V	Fluke 434-II: ≥ 204.2 V Fluke 435-II /437-II: ≥ 204.25 V

- Set the Calibrator to STBY.

Accuracy Check of Channel N (Neutral):

- Connect the N input with the C/L3 input (See Figure 4-4). A/L1, B/L2, C/L3 now give zero reading.
- Set the Calibrator to 50 Hz / 115 V and then to OPR.
- Fluke 434-II: check for a voltage readout V rms between 113.8 ... 116.2 V.
Fluke 435-II/437-II: check for a voltage readout V rms between 114.77 ... 115.23 V.
- Check the 230 V range according to the table below.

Table 4-8. Accuracy Check of Voltage Channel N (Neutral)

Set Calibrator to	Readout at Voltage Channel N
115 V, 50 Hz, OPR	Fluke 434-II: 113.8 ... 116.2 V Fluke 435-II /437-II: 114.77 ... 115.23 V
230 V, 50 Hz, OPR	Fluke 434-II: 228.8 ... 231.2 V Fluke 435-II /437-II: 229.77 ... 230.23 V
460 V, 50 Hz, OPR	Fluke 434-II: 458.8 ... 461.2 V Fluke 435-II /437-II: 459.77 ... 460.23 V

15. Set the Calibrator to STBY.

Optional Test. Bandwidth Check of Channel N (*):

16. Set the Calibrator to 215 V, 50 Hz and OPR.

17. Now check the voltage channel N. Use the Calibrator's field edit function (AMPL/FREQ key) to adjust the Calibrator to an Analyzer readout of 215.0 V / 215.00 V.

18. Increase the frequency to 3 kHz.

Fluke 434-II: check for a readout of 204.2 V or more.

Fluke 435-II/437-II: check for a readout of 204.25 V or more.

19. Set the Calibrator to STBY.

4.8.4 Verification of voltage inputs in 400 V range

Accuracy Check of Channel A/L1, B/L2, C/L3:

1. Set the Analyzer to 400 V, 50 Hz nominal (SETUP menu, arrow and ENTER keys). Press MENU, select Volts/Amps/Hertz, press F5 - OK.
2. To check the A/L1, B/L2, C/L3 inputs: connect the N input to Ground (See Figure 4-3).
3. Set the Calibrator to 50 Hz, 200 V and then to OPR.
4. Fluke 434-II: check for a voltage readout V rms between 198.0 ... 202.0 V.
Fluke 435-II/437-II: check for a voltage readout V rms between 199.60 ... 200.40 V.
5. Check the 400 V range according to the table below.

Table 4-9. Accuracy Check of Voltage Channels A/L1, B/L2, C/L3

Set Calibrator to	Readout at Voltage Channels
200 V, 50 Hz, OPR	Fluke 434-II: 198.0 ... 202.0 V Fluke 435-II /437-II: 199.60 ... 200.40 V
400 V, 50 Hz, OPR	Fluke 434-II: 398.0 ... 402.0 V Fluke 435-II /437-II: 399.60 ... 400.40 V
800 V, 50 Hz, OPR	Fluke 434-II: 798.0 ... 802.0 V Fluke 435-II /437-II: 799.20 ... 800.80 V

6. Set the Calibrator to STBY.

Optional Test. Bandwidth Check of Channel A/L1, B/L2, C/L3 (*):

7. Set the Calibrator to 215 V, 50 Hz and OPR.
8. Now check the voltage channels one by one. Use the Calibrator's field edit function (AMPL/FREQ key) to adjust the Calibrator to an Analyzer readout of 400.0 V / 215.00 V.
9. Increase the frequency to 3 kHz.
 Fluke 434-II: check for a readout of 204.2 V or more.
 Fluke 435-II/437-II: check for a readout of 204.25 V or more.
 Check the channels according to the table below.

Table 4-10. Bandwidth Check of Voltage Channels A/L1, B/L2, C/L3

Voltage Channel to be verified	Readout at 50 Hz (adjust Calibrator with EDIT FIELD)	Readout at 3 kHz
A/L1	Fluke 434-II: 215.0 V Fluke 435-II /437-II: 215.00 V	Fluke 434-II: ≥ 204.2 V Fluke 435-II /437-II: ≥ 204.25 V
B/L2	Fluke 434-II: 215.0 V Fluke 435-II /437-II: 215.00 V	Fluke 434-II: ≥ 204.2 V Fluke 435-II /437-II: ≥ 204.25 V
C/L3	Fluke 434-II: 215.0 V Fluke 435-II /437-II: 215.00 V	Fluke 434-II: ≥ 204.2 V Fluke 435-II /437-II: ≥ 204.25 V

10. Set the Calibrator to STBY.

Accuracy Check of Channel N (Neutral):

11. Connect the N input with the C/L3 input (See Figure 4-4). A/L1, B/L2, C/L3 now give zero reading.
12. Set the Calibrator to 50 Hz / 200 V and then to OPR.
13. Fluke 434-II: check for a voltage readout V rms between 198.0 ... 202.0 V.
 Fluke 435-II/437-II: check for a voltage readout V rms between 199.60 ... 200.40 V.
14. Check the 400 V range according to the table below.

Table 4-11. Accuracy Check of Voltage Channel N (Neutral)

Set Calibrator to	Readout at Voltage Channel N
200 V, 50 Hz, OPR	Fluke 434-II: 198.0 ... 202.0 V Fluke 435-II /437-II: 199.60 ... 200.40 V
400 V, 50 Hz, OPR	Fluke 434-II: 398.0 ... 402.0 V Fluke 435-II /437-II: 399.60 ... 400.40 V
800 V, 50 Hz, OPR	Fluke 434-II: 798.0 ... 802.0 V Fluke 435-II /437-II: 799.20 ... 800.80 V

15. Set the Calibrator to STBY.

Optional Test. Bandwidth Check of Channel N (*):

16. Set the Calibrator to 215 V, 50 Hz and OPR.

17. Now check the voltage channel N. Use the Calibrator's field edit function (AMPL/FREQ key) to adjust the Calibrator to an Analyzer readout of 400.0 V / 215.00 V.

18. Increase the frequency to 3 kHz.

Fluke 434-II: Check for a readout of 204.2 V or more.

Fluke 435-II/437-II: Check for a readout of 204.25 V or more.

19. Set the Calibrator to STBY.

4.8.5 Verification of voltage inputs in 6 kV range (Transients)

Note: this test is not required for Fluke 434-II.

Set the Analyzer to Transients mode (Analyzer remains in 400 V, 50 Hz nominal).

Press MENU, press F2 – PAGE 2, select Transients, then F5 – OK.

In the START screen: Voltage Swell must be on; the other 4 functions must be off.

Then press F5 - RUN.

Accuracy Check of Channel A/L1, B/L2, C/L3:

1. To check the A/L1, B/L2, C/L3 inputs: connect the N input to Ground (See Figure 4-3).
2. Set the Calibrator to 50 Hz, 400 V and then to OPR.
3. Check for a voltage readout V rms between 390.0 ... 410.0 V in the screen header.
4. Check the 6 kV range according to the table below.

Table 4-12. Accuracy Check of Voltage Channels A/L1, B/L2, C/L3

Set Calibrator to	Readout at Voltage Channels
400 V, 50 Hz, OPR	390.0 ... 410.0 V
1000 V, 50 Hz, OPR	990.0 ... 1010 V

5. Set the Calibrator to STBY.

Optional Test. Bandwidth Check of Channel A/L1, B/L2, C/L3 (*):

6. Set the Calibrator to 215 V, 50 Hz and OPR.
7. Now check the voltage channels one by one. Use the Calibrator's field edit function (AMPL/FREQ key) to adjust the Calibrator to an Analyzer readout of 215 V.
8. Increase the frequency to 3 kHz.
 Fluke 435-II/437-II: check for a readout of 204.2 V or more.
 Check the channels according to the table below.

Table 4-13. Bandwidth Check of Voltage Channels A/L1, B/L2, C/L3

Voltage Channel to be verified	Readout at 50 Hz (adjust Calibrator with EDIT FIELD)	Readout at 3 kHz
A/L1	Fluke 435-II /437-II: 215 V	Fluke 435-II /437-II: ≥ 204.2 V
B/L2	Fluke 435-II /437-II: 215 V	Fluke 435-II /437-II: ≥ 204.2 V
C/L3	Fluke 435-II /437-II: 215 V	Fluke 435-II /437-II: ≥ 204.2 V

9. Set the Calibrator to STBY.

Accuracy Check of Channel N (Neutral):

10. Connect the N input with the C/L3 input (See Figure 4-4). A/L1, B/L2, C/L3 now give zero reading.
11. Set the Calibrator to 50 Hz / 400 V and then to OPR.
12. Check for a voltage readout V rms between 390.0 ... 410.0 V.
13. Check the 6 kV range according to the table below.

Table 4-14. Accuracy Check of Voltage Channel N (Neutral)

Set Calibrator to	Readout at Voltage Channels N
400 V, 50 Hz, OPR	390.0 ... 410.0 V
1000 V, 50 Hz, OPR	990.0 ... 1010 V

14. Set the Calibrator to STBY.

Optional Test. Bandwidth Check of Channel N (*):

15. Set the Calibrator to 215 V, 50 Hz and OPR.
16. Now check the voltage channel N. Use the Calibrator's field edit function (AMPL/FREQ key) to adjust the Calibrator to an Analyzer readout of 400 V / 215 V.

17. Increase the frequency to 3 kHz.
Fluke 435-II/437-II: check for a readout of 204.2 V or more.
18. Set the Calibrator to STBY.

Note: bandwidth will be slightly higher than in V/A/Hz mode because a low pass filter in the analog input channel is off during Transients mode.

4.9 Channel Isolation (*)

This optional test verifies cross talk from voltage channels to current channels. Voltage channels normally get high voltages while the current channels have a sensitivity of a couple of volts. This way of testing verifies the most critical situation.

Proceed as follows:

1. Connect the Analyzer's A/L1, B/L2, C/L3, and N voltage inputs with the HI output of the Calibrator.
Connect the Analyzer's GND input with the LO output of the Calibrator.
2. Set all current channels (Phase and Neutral) to 1 mV/A, 1000 A, x1 AC + DC, 1:1 (SETUP key, F4 – MANUAL SETUP, use arrow and ENTER keys).
Put the Analyzer in 3-phase WYE, 50 Hz, 400V, and V/A/Hz mode.
3. Short-circuit the four current inputs with a termination piece of 50 Ω or lower. Refer to Figure 4-5.
4. Set the Calibrator to 800 V, 50 Hz, and OPR.
5. Check that the readout on all current channels does not exceed 19 A (this includes the 5 A basic error of the current channels).
6. Set the Calibrator to STBY.
7. Disconnect all test leads.
8. If removed, install the SD memory card again.

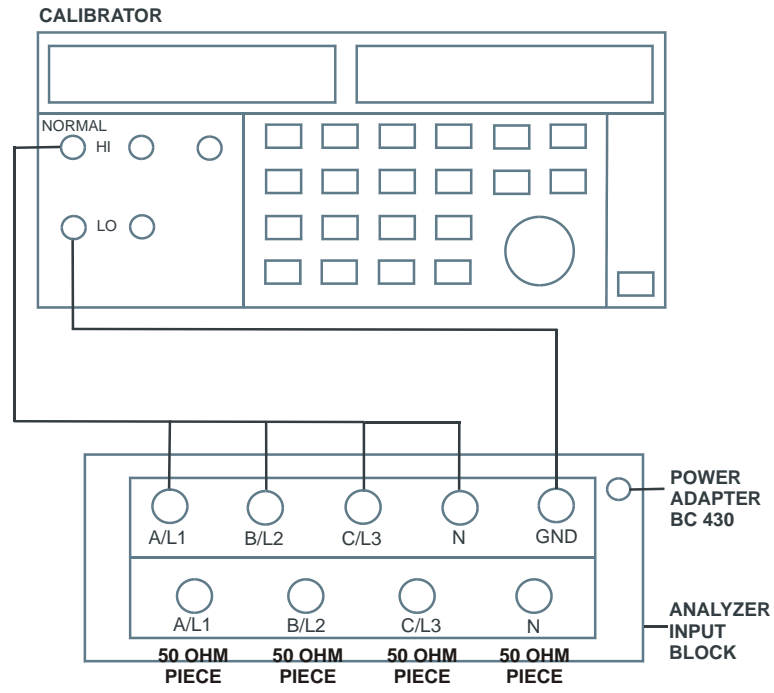

Figure 4-4. Checking the Channel isolation.

Chapter 5

Calibration Adjustment

Title	Page
5.1 General.....	5-3
5.1.1 Introduction	5-3
5.1.2 Calibration number and date	5-3
5.1.3 General instructions.....	5-3
5.1.4 Equipment required for calibration	5-4
5.2 Calibration Procedure Steps.....	5-4
5.3 Starting The Calibration.....	5-4
5.4 Contrast Calibration Adjustment	5-6
5.5 Warming Up	5-7
5.6 Final Calibration	5-8
5.6.1 Warming Up Final.....	5-8
5.6.2 Offset adjustment	5-8
5.6.3 Low voltage and current gain adjustment	5-10
5.6.4 Current gain 10x.....	5-10
5.6.5 Voltage gain adjustment.....	5-10
5.7 Save Calibration Data And Exit.....	5-12

5.1 General

5.1.1 Introduction

The following information, provides the complete Calibration Adjustment procedure for the Fluke 434-II/435-II/437-II Energy & Power Quality Analyzer (referred to as Analyzer). The Analyzer allows closed-case calibration using known reference sources. It measures the reference signals, calculates the correction factors, and stores the correction factors in RAM. After completing the calibration, the correction factors are stored in FlashROM so that they stay available are disconnection from all power sources.

The Analyzer should be calibrated after repair, or if it fails the performance test. The Analyzer has a normal calibration cycle of one year.

5.1.2 Calibration number and date

When storing valid calibration data in FlashROM after performing the calibration adjustment procedure, the calibration date is set to the actual Analyzer date, and calibration number is raised by one. To display the calibration date and - number:

1. Press **F1** to leave the Language selection menu. Then **SETUP**, and then press **F2** to see the Version & Calibration data (see Figure 5.1).
2. Press **F5** to return to exit the Version & Calibration screen.



Figure 5-1. Version & Calibration data.

5.1.3 General instructions

Follow these general instructions for all-calibration steps:

- Allow the Calibrator to satisfy its specified warm-up period. After each change of output conditions, wait for the Calibrator to settle. It may take a couple of seconds for the output voltage to stabilize!
- The required warm up period for the Analyzer is included in the Warming Up period (Calibration step CL 0200).
- Ensure that the Analyzer battery is charged sufficiently.

- Power the Analyzer via the BC430 Power Adapter (or any other type that is recommended by Fluke as suitable).

5.1.4 Equipment required for calibration

The primary source instrument used in the calibration procedures for Fluke 434-II/435-II/437-II (Series II) is the Fluke 5700A Calibrator. If the required type is not available, you can substitute another Calibrator as long as it meets the minimum test requirements.

- Fluke 5700A Calibrator.
- Stackable safety test leads (4x), as supplied with the Calibrator.
- Extra set of test leads capable to withstand 1000 V rms.
Note: for good recognition it is advised to use a black lead between the Calibrator's LO output and the Analyzer's Ground banana input.
- 50Ω Coax Cables (3 pieces required): Fluke PM9092 (0.5m, set of 3, 1 set required).
- Male BNC to Dual Female BNC adapter: Fluke PM9093 (3 pieces required).
- Dual Banana Jack to female to male BNC: Fluke PM9082 (1 piece required).
- Power Adapter: BC430.











5.2 Calibration Procedure Steps



To do a **complete** calibration adjustment you must do all following steps:

1. Select the Calibration Mode, section 5.3
2. Do the Contrast Calibration Adjustment, section 5.4
3. Do the Warming Up, section 5.5
4. Do the Final Calibration, section 5.6
5. Save the Calibration Data and Exit the calibration mode, section 5.7

5.3 Starting The Calibration

Follow the steps below to start the calibration:



1. Power the Analyzer via the power adapter input using the BC430 power adapter.
2. With the Analyzer in off position, keep  pressed. Press  to turn the Analyzer on. A **double beep** indicates that the Analyzer is has been set to default settings. Next release . Use the default position to start calibration adjustment.
3. Press , then  and then  - MANUAL SETUP and check the actual Analyzer date. If necessary adjust the date (the calibration date will become the Analyzer date when saving the calibration data):
 - Operate   to highlight the Date.
 - Press  to open the SETUP DATE menu.
 - Operate   to select in sequence Year, Month, and Day.

- Operate  to adjust each selected item Year, Month, and Day.
- Press  to leave the SETUP DATE menu.

4. Select the calibration mode.

The Calibration Adjustment Procedure uses built-in calibration setups, that can be accessed in the calibration mode.

To enter the calibration mode proceed as follows:

- Press and hold  , press and release  , then release .





The display shows the **MAINTENANCE** screen (Calibration Adjustment mode).

The display shows the calibration step **Warming Up (CL 0200)** , the calibration status **:IDLE (valid)** or **:IDLE (invalid)** , and the soft key menu.

Continue as indicated in section 5.2.

You can leave the calibration mode without changing the calibration data by turning the Analyzer off.

Explanation of screen messages and key functions.

When the Analyzer is in the calibration Mode, only the  to  soft keys, the  and the  key can be operated, unless otherwise stated.

The calibration adjustment screen shows the actual calibration step (name and number) and its status: **Cal Name (CL nnnn) :Status (...)**

Cal Name Name of the selected calibration step, e.g. **Warming Up**

(CL nnnn) Number of the calibration step

Status (...) can be:





IDLE (valid) After (re)entering this step, the calibration process is not started. The calibration data of this step are valid. This means that the last time this step was done, the calibration was successful. It does not necessarily mean that the unit meets the specifications related to this step!

IDLE (invalid) After (re)entering this step, the calibration process is not started. The calibration data are invalid. This means that the last time this step was done, the calibration was not successful. Most probably the unit will not meet the specifications if the actual calibration data are saved.

BUSY aaa% bbb% Calibration adjustment step in progress; progress % for Input A and Input B. During Warming Up the elapsed time is shown.

READY Calibration adjustment step finished.

Functions of the keys F1-F4 are:

- | | | |
|---|-------------|---|
|  | PREV | select the previous step |
|  | NEXT | select the next step |
|  | CAL | start the calibration adjustment of the actual step |
|  | EXIT | leave the calibration mode |

















5.4 Contrast Calibration Adjustment

After entering the calibration mode the display shows:

WarmingUp (CL 0200):IDLE (invalid)

Do not press  now! If you did, turn the Analyzer off and on, and enter the calibration mode again.

Proceed as follows to adjust the maximum display darkness (CL 0100), the default contrast (CL 0110), and the maximum display brightness (CL 0120).

1. Press  three times to select maximum darkness calibration **Contrast (CL 0100)**:
2. Press  **CALIBRATE**. The display will show a dark test pattern, see Figure 5-2
3. Using   adjust the display to the maximum darkness at which the test pattern is only just visible (up = lighter, down = darker).
4. Press  to return to the soft key menu.
5. Press  to select default contrast calibration **Contrast (CL 0110)**:
6. Press  **CALIBRATE**. The display shows the test pattern at default contrast.
7. Using   set the display to optimal (becomes default) contrast (up = lighter, down = darker).
8. Press  to return to the soft key menu.
9. Press  to select maximum brightness calibration **Contrast (CL 0120)**:
10. Press  **CALIBRATE**. The display shows a bright test pattern.
11. Using   adjust the display to the maximum brightness, at which the test pattern is only just visible.
12. Press  to return to the soft key menu (up = lighter, down = darker).
13. Now do the complete calibration. Press  to select the next step (Warming Up), and continue at Section 5.5.

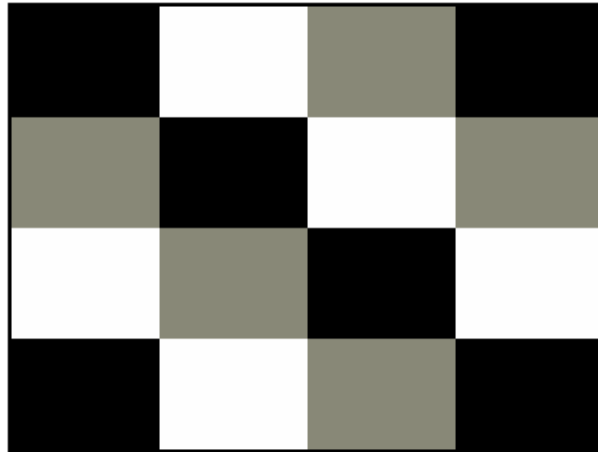

Figure 5-2. Version & Calibration data.

5.5 Warming Up

The Warming Up state will be entered after entering the calibration mode (section 5.3), or after selecting the next step if you have done the Contrast Calibration step CL 120 (section 5.4). The display will show

WarmingUp (CL 0200):IDLE (valid) or (invalid).

Unless you want to calibrate the display contrast only, you must always start the calibration adjustment at the **Warming Up (CL 0200)** step. Starting at another step will make the calibration invalid!

The Warming Up consists of a 30 minutes warming-up period.

Proceed as follows to do the Warming Up:

1. Remove all input connections from the Analyzer.
2. Press **F3** to start the Warming-Up.
The display shows the calibration step in progress, and its status.
The display shows **WarmingUp (CL 0200) :BUSY 00:29:59** . The warming-up period is counted down from 00:29:59 to 00:00:00
3. Wait until the display shows **Warmingup: READY**
If you turn off the Analyzer now by accident, turn it on again immediately; now you can select the calibration mode, and continue with step 4 below (press **F2** **NEXT** several times, see 5.6).
If you turn off the instrument now, and you do not turn on immediately, the Analyzer has cooled down, and you must repeat the Warming Up (select the calibration mode and start at CL 0200).
4. Press **F2** **NEXT** and continue at Section 5.6.

5.6 Final Calibration

Before starting the final calibration you must have done the Warming Up (section 5.5)!

The final calibration is simple and straightforward and consists of the following elements:

- Offset adjustment of voltage and current inputs (0 V input signal).
- Low voltage adjustment of voltage and current inputs (0.67 V rms, 50 Hz input signal).
- Low voltage adjustment of gain x10 of current inputs (0.2 V rms, 50 Hz input).
- Voltage gain adjustment of voltage inputs (120/230/480/600 V rms, 50 Hz input).

The final calibration requires input conditions that will be described in each step. You must always start the Final Calibration at the first step, see Section 5.6.1. Starting at another step will make the calibration invalid!

If you proceeded to calibration step N (for example step CL 0320), then return to a previous step (for example step CL 0310) , and then calibrate this step, the complete final calibration becomes invalid; then you must repeat the calibration starting at 5.6.1.

It is allowed to repeat a step that shows the status **:READY** by pressing **F3** again.

5.6.1 Warming Up Final

Proceed as follows to do the Warming Up Final adjustment:

1. Press **F2** NEXT to select Calibration step CL 0201. Do NOT apply any input signal (open inputs).
2. Press **F3** CALIBRATE.
3. Wait until the display shows **:READY**.
4. Press **F2** NEXT and continue at section 5.6.2.

5.6.2 Offset adjustment

Proceed as follows to do the Offset adjustment of all inputs:

5. Connect the Analyzer to the Calibrator as shown in Figure 5-3.

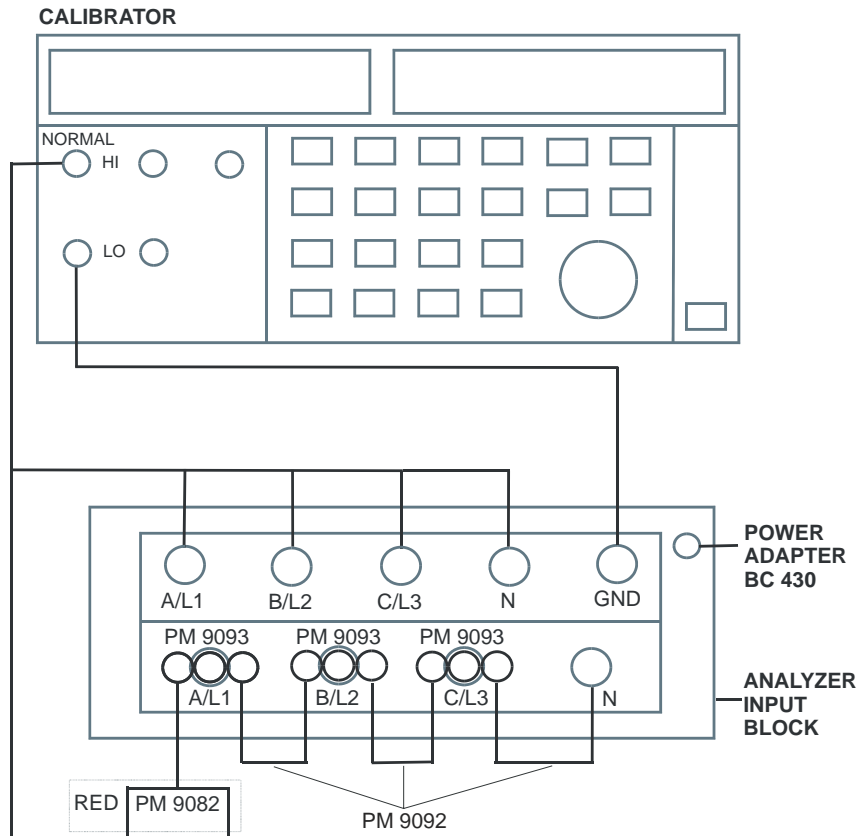

Figure 5-3. Offset, Low Voltage, and Current Gain Adjustment

2. The display must show step CL 0300.
If it does not, then press **F1** or **F2** to select the first calibration step in Table 5-1.
3. Set the Calibrator output to source the signal 0 Hz, 0 V required for the calibration steps in Table 5-1.
4. Set the Calibrator in operate (OPR) or standby (STBY) as indicated.
5. Press **F3** to start the calibration.
6. Wait until the display shows calibration status **:READY**.
7. Press **F2** to select the next calibration step, and start the calibration.
Continue through all calibration points of Table 5-1.
8. When you are finished, set the Calibrator to Standby (STBY).
9. Continue at Section 5.6.3.

Table 5-1. Offset Adjustment of all Inputs

Cal step	Description	Calibrator Setting
CL 0300	OffsetLowVolt	0 V, 0 Hz, OPR
CL 0310	Offset125Volt	0 V, 0 Hz, OPR
CL 0320	Offset250Volt	0 V, 0 Hz, OPR
CL 0330	Offset500Volt	0 V, 0 Hz, OPR
CL 0340	Offset6KVolt	0 V, 0 Hz, OPR
---	---	STBY

5.6.3 Low voltage and current gain adjustment

Proceed as follows to do the Low Voltage and Current Gain Adjustment:

1. Press **F2** to select calibration step CL 0400.
2. Keep the Analyzer connected to the Calibrator as shown in Figure 5-3.
3. Set the Calibrator to source 0.67 V, 50 Hz .
4. Set the Calibrator to operate (OPR).
5. Press **F3** to start the calibration.
6. Wait until the display shows calibration status **:READY** .
7. Set the Calibrator to Standby (STBY).

5.6.4 Current gain 10x

Proceed as follows to do the Current 10x Gain Adjustment:

3. Press **F2** to select calibration step CL 0405.
4. Connect the Analyzer to the Calibrator as shown in Figure 5-3.
8. Set the Calibrator to source 0.2 V, 50 Hz .
9. Set the Calibrator to operate (OPR).
10. Press **F3** to start the calibration.
11. Wait until the display shows calibration status **:READY** .
12. Set the Calibrator to Standby (STBY).
13. Continue at section 5.6.5.

5.6.5 Voltage gain adjustment

Proceed as follows to do the Voltage gain Adjustment.

1. Press **F2** to select the first calibration step in Table 5-2 (CL 0410).
2. Connect the Analyzer to the Calibrator as shown in Figure 5-4: disconnect the current inputs!

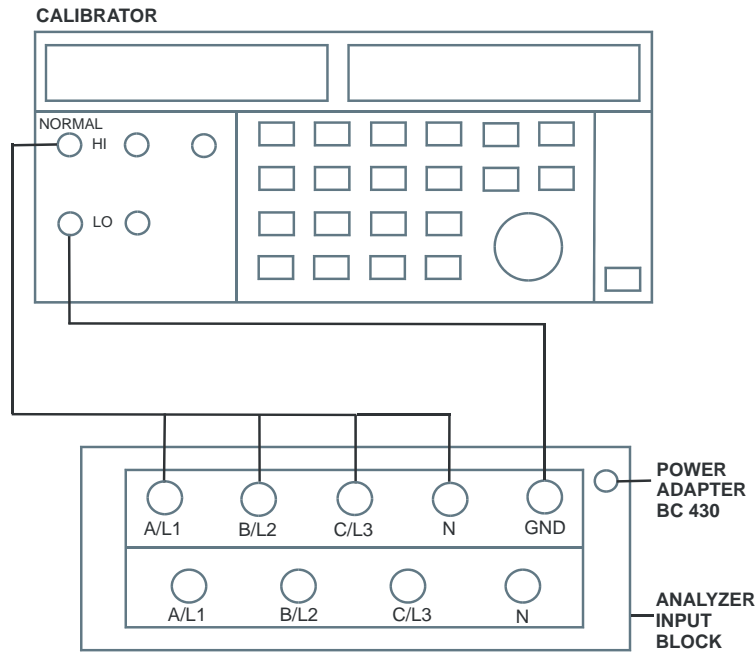

Figure 5-4. Voltage Gain Adjustment

3. Set the Calibrator to supply 120 V, 50 Hz.

Warning

Dangerous voltages will be present on the calibration source and connection cables during the following steps. Ensure that the Calibrator is in standby (STBY) mode before making any connection between the Calibrator and the Analyzer.

4. Set the Calibrator to operate (OPR).
5. Press **F3** to start the calibration.
6. Wait until the display shows calibration status **:READY**.
7. Press **F2** to select the next calibration step, set the Calibrator to the next calibration point, and start the calibration. Continue through all calibration points of Table 5-2.
8. Set the Calibrator to STBY (Standby).

Table 5-2. Voltage Gain Adjustment

Cal step	Description	Calibrator Setting
CL 0410	Gain125Volt	120 V, 50 Hz, OPR
CL 0420	Gain250Volt	230 V, 50 Hz, OPR
CL 0430	Gain500Volt	480 V, 50 Hz, OPR
CL 0440	Gain6KVolt	600 V, 50 Hz, OPR
---	---	STBY

9. Continue at section 5.7

5.7 Save Calibration Data And Exit

Proceed as follows to save the calibration data, and to exit the Maintenance mode:

1. Remove all test leads from the Analyzer inputs.
2. Press **F5** **EXIT**. The Analyzer will display:

**Calibration data valid.
Save data and exit maintenance mode?**

Note

Calibration data valid indicates that the calibration adjustment procedure is performed correctly. It does not necessarily mean that the Analyzer meets the characteristics listed in the Analyzer's Users Manual (Refer to Chapter 2).

3. Press **F5** **YES** to save and exit.

Note 1

After saving the calibration data, the calibration number and - date will be updated if the calibration data have been changed and the data are valid. The calibration number and - date will not change if:

- the calibration mode is entered and left without doing a calibration adjustment.
- only the contrast calibration adjustment (5.4) and/or the probe calibration is done.

Note 2

*If you press **F4** **NO**, the Analyzer returns to the calibration mode. You can either calibrate the Analyzer again, or press **F5** **EXIT**, **F5** **YES** to save and exit.*

Possible error messages.

The following messages can be shown on the Analyzer display:

**WARNING: Calibration data not valid.
Save data and exit maintenance mode?**

Proceed as follows:

- If you did the Warming Up and Pre-Calibration successfully (section 5.5), and you want to store the Pre-Calibration data before continuing with the Final Calibration:

⇒ Press **F5** **YES**.

When turning the Analyzer off and on again, it will show the message:

**The instrument needs calibration.
Please contact your service center.**

The calibration date and number will not be updated. You must continue with the Final Calibration!

- To return to the Maintenance mode, if you want to repeat the complete calibration:

⇒ Press **F4** **NO**.

Now press **F1** until the display shows **Warming Up (CL 0200):IDLE**, and calibrate the Analyzer, starting at section 5.5.

- If you want to exit and maintain the old calibration data:

Turn the Analyzer off.

Chapter 6

Disassembling the Analyzer

Title	Page
6.1. Introduction.....	6-3
6.2. Disassembly & Reassembly Procedures.....	6-3
6.2.1 Required Tools	6-3
6.2.2 Removing the Tilt Stand, Hang Strap, and Side Strap	6-3
6.2.3 Opening the Analyzer, Removing the Battery Pack.....	6-4
6.2.4 Getting access to Top Side of PCA	6-5
6.2.5 Getting access to Bottom Side of PCA.....	6-5
6.2.6 Getting access to LCD, Keypad Foil and Keypad.....	6-5
6.2.7 Pictures Showing Disassembly Steps	6-6

6.1. Introduction

This section provides the required disassembling procedures. The printed circuit assembly removed from the Analyzer must be adequately protected against damage.

The Analyzer contains static sensitive components. Handling and servicing these components should be done only at a static free workstation by qualified personnel.

The Analyzer contains a Li-ion battery pack. Refer to the Fluke 434-II/435-II/437-II (Series II) Users Manual 'Safety Information' Chapter (page 1-7 onwards) for instructions how to safely handle and use this battery pack. The Users Manual can be downloaded from Fluke's website.

In the Analyzer a number of selftapping screws are used. When mounting these screws again it is advised to use a hand-operated screwdriver and reinsert them into the 'tracks' already present in the plastic. This assures a longer life of the plastic parts of the housing.

At the end of this chapter a number of pictures shows the various stages of disassembling.

Warning

To avoid electric shock, disconnect test leads, probes and power supply from any live source and from the Analyzer itself. Always remove the battery pack before completely disassembling the Analyzer. Only qualified personnel using customary precautions against electric shock should work on a disassembled unit with power on.

Important: the Analyzer has a battery door that is fixed with 2 quarter turn screws.

Behind the door are located the Li-ion battery and the SD memory card.

If the SD card is not installed, only momentary measurements such as a meter screen can be done. Measurements over time such as Monitor or trend are not possible then.

If the battery is not installed the Analyzer can work on the Power Adapter BC430. The battery itself is provided with a 'Fuel Gauge' LCD display with 5 segments each representing about 20 % of the battery's total capacity.

The battery door has optical detection device that prevents the Analyzer from starting up if the door is not closed.

6.2. Disassembly & Reassembly Procedures

6.2.1 Required Tools

To access all the assemblies, you need the following:

- Static-free work surface, and anti-static wrist wrap.
- #10 Torx screwdriver.
- A small screwdriver or pair of tweezers to unlock flatcables from their connector.
- Cotton gloves (to avoid contaminating the lens, and the PCA).

6.2.2 Removing the Tilt Stand, Hang Strap, and Side Strap

To separate the Tilt Stand from the Rear Case: gently bend one rotation point away from the Rear Case and move the stand away from the housing. There is no need to remove screws or other fixing devices.

Before opening the Analyzer, you must remove the Hang Strap and the Side Strap. How to remove and install the Hang Strap is explained in the Users Manual in Chapter 4. The grip of the Side Strap consists of two halves kept together with Velcro tape. After having opened it, the straps can be taken apart and be removed from their fixing dowels in the side of the Analyzer. Before doing this, take careful notice on the correct position of the strap. To install work in reverse order.

6.2.3 Opening the Analyzer, Removing the Battery Pack

Proceed as follows (Figure 6-1):

1. Remove the battery access door with a standard blade screwdriver by turning the plastic battery door screws one-quarter turn counterclockwise.
2. Take the battery and the SD memory card out of the instrument. The correct insert position of the memory card is indicated with an arrow in the compartment. When installing the SD card, press it into its slot until a click is experienced. This click indicates that the card is locked into its slot.
Note: take care not to short circuit the battery's contacts. Never open or damage the battery's housing. Do not touch the contacts of the memory card in order to avoid contamination.
3. When present, take off the Hang Strap and the Side Strap (refer to 6.2.2.).
4. Loosen the two black selftapping screws about 12 mm long (total length) that fix the grey/yellow Input Cover (Topholster) that is around the BNC-input (and banana) sockets.
5. Take the Input Cover (Topholster) off.

Note: when reinstalling the Input Cover (Topholster) do not forget to reinstall the flexible Sealing Strip around the input sockets! The holes in this strip are arranged in such a way that there is only one correct position possible.

Note: when reinstalling the Input Cover, do not forget to reinstall 4 steel pins (2x17 mm) in the left and right side of the instrument. The pins are used to attach the Hang Strap and the Side Strap.

6. Remove 2 screws M3x7 from the Bottomholster. The screws fit into square nuts that in turn fit into the Rear Case. Take care that the square nuts are not lost.
7. Take the Bottomholster off.
Note: when reinstalling the Holster, take care to reinstall 2 steel pins (2x17 mm) in the left and right side of the instrument. The pins are used to attach the Side Strap. Take care that the yellow covers of USB-input and on the right side are correctly in place.
8. Remove four selftaping screws 16.5 mm long (total length) that attach the Rear Case. Two of these screws are located inside the battery compartment.
9. Take the Bottom Case off. Unplug the connector of the battery door detection.

Note: when reinstalling the Bottom Case, do not forget to put the steel plate 16x17 mm in place again. This plate is present in the cavity on the right-hand side of the instrument and its purpose is to attach a Kensington Lock.

Note: when reinstalling the Bottom Case, do not forget to reinsert the connector of the battery door detection.

Note: when reinstalling the bottom case, take care that flat cables to LCD,

keyboard and wiring of battery door detection are not damaged inbetween case parts.

6.2.4 Getting access to Top Side of PCA

During disassembly, take careful notice of the position of isolation foils in so that you are able to install them in their original position. This is very important for the Analyzer's safety. To get access to the top side, remove the upper plate (Shielding Lid): remove 4 pcs. M3 screws (total length of 6 mm). Refer to figure 6-2.

6.2.5 Getting access to Bottom Side of PCA

Important: to avoid contaminating the flex cable contacts with grease from your fingers, do not touch these contacts (or wear cotton gloves). Contaminated contacts may not cause immediate instrument failure. Failures typically show up when contaminated instruments are operated in humid areas. Refer to figure 6-3.

1. Unlock both flat cables by shifting the connector latch at the left and right edge with a small screwdriver. The latch is an integral part of the connector body. The figure below shows this.
2. Remove the flat cables from connector J1201 (to LCD), J1000 (to keyboard), J1200 (to LCD backlight).
3. Remove 7 pcs. M3 screws (total length 9 mm) that fix the PCA to the lower chassis (Shielding Assy).
4. Take notice of the position of 2 black rubber sealing pieces of which one fits around the USB-connector. These sealing pieces are essential for the Analyzer's safety.
5. Unlock the PCA at the side with BNC's/banana inputs and separate it from the lower chassis plate.

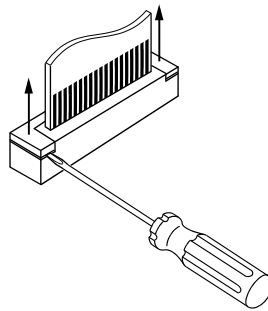

ST6682

6.2.6 Getting access to LCD, Keypad Foil and Keypad

Proceed as follows (Figure 6-4, 6-5):

1. Unlock both flat cables by shifting the connector latch at the left and right edge using a small screwdriver. The latch is an integral part of the connector body.
2. Remove the flat cables from connector J1201 (to LCD), J1000 (to keyboard), J1200 (to LCD backlight).
3. Remove 4 selftapping screws 10.5 mm long (total length) that fix the Main PCA module to the top case assembly. The screws are grouped around the Analyzer's LCD.

4. Remove the remaining 2 selftapping screws 8.5 mm long (total length) that fix the Main PCA module to the top case assembly. The screws are located at the bottom side of the keyboard.
5. Separate the Main PCA module from the top case.
6. Now you have access to LCD-module, keypad foil and keypad. They can be separated from top case without the removal of screws or clamps. Do not touch contact areas with your hands in order to avoid contamination (or wear cotton gloves).

Note: when installing the LCD-module into the top case, take care that no dust or dirt is present between module and the window/decals.

6.2.7 Pictures Showing Disassembly Steps

Note: pictures may be subject to minor changes without prior notice.

Fig. 6-1. Dismantling step 1 (bottom case removed)



Fig. 6-2. Dismantling step 2 (Top side of PCA attainable)

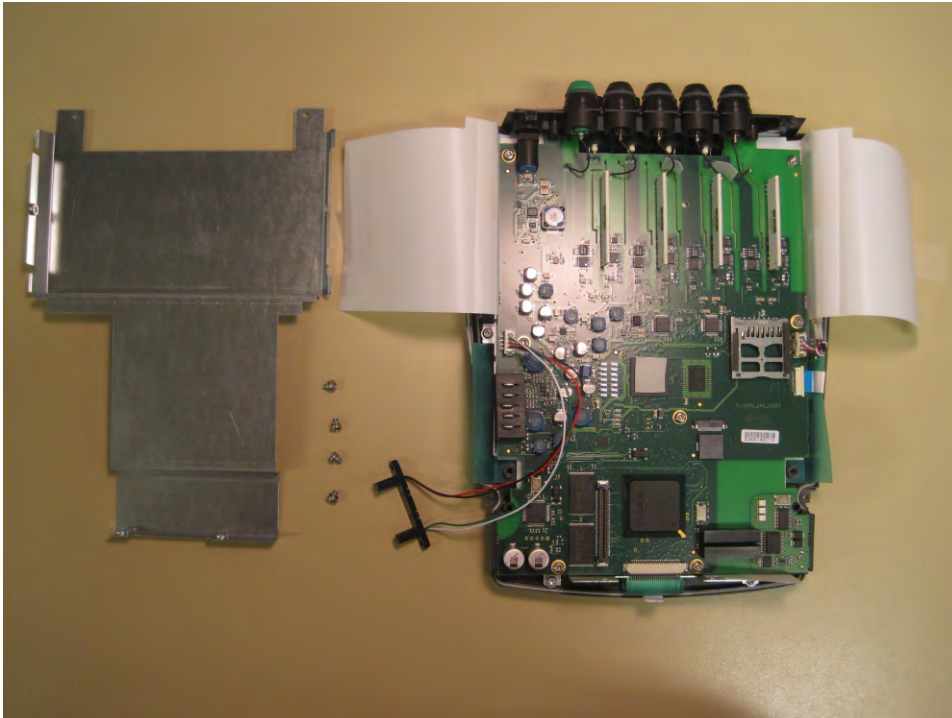

Fig. 6-3. Dismantling step 3 (PCA separated from chassis)



Fig. 6-3. Dismantling step 4 (Main PCA Module separated from front case)

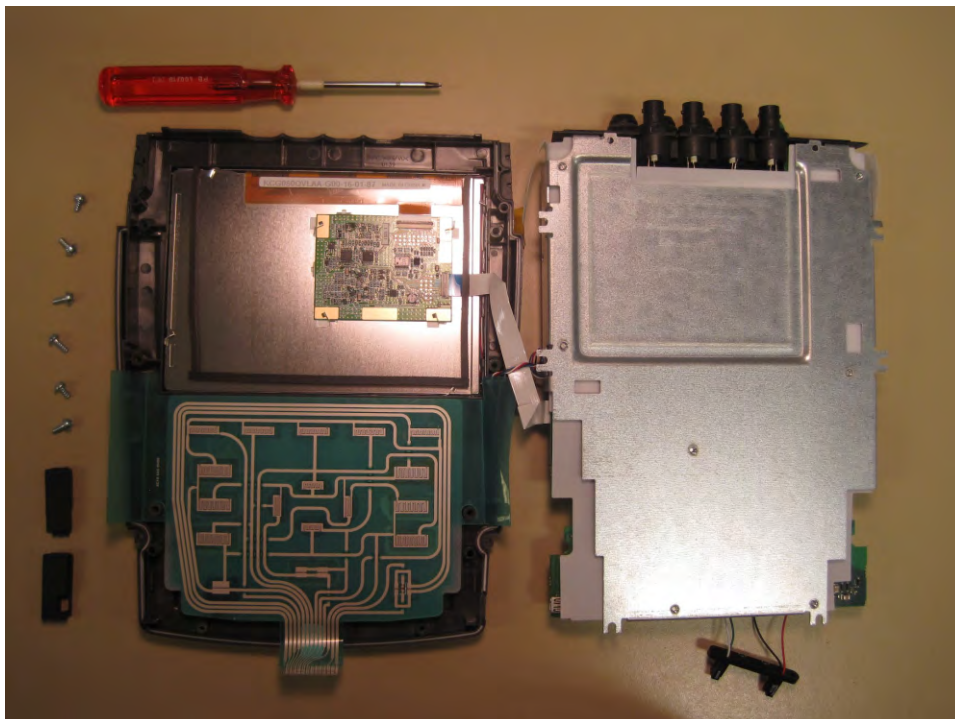

Fig. 6-5. Dismantling step 5 (Main PCA Module separated from front case, keypad foil removed)

