

Ground-Tite® Grounding Liquidtight Connectors

Type 4Q-L

Straight Connectors

Use:

Secures, grounds and seals liquidtight flexible metal conduit and terminates bonding conductor run externally alongside liquidtight conduit.

Features:

- Positive grounding type
- Tapered threaded male hub NPT
- Grounding lug is cast as an integral part of malleable iron gland nut. Provides high ground fault withstand capability
- Compact, slim diameter with small turning radius
- Furnished with locknut and KO sealing ring.
- Liquidtight/Raintight/Oiltight/Concretetight
- UL Listed NEMA Type 4 when installed into a NPT threaded entry or UL Listed conduit hub (sizes 1½" and larger require thread sealant).
- Suitable for use in the following

Hazardous Locations:

- Class I, Div. 2 per NEC 501.4(B)
- Class I, Zone 2 per NEC 505.15(C)(2)
- Class II, Div. 1 per NEC 502.4(A)(1)(e)
- Class II, Div. 2 per NEC 502.4(B)(2)
- Class III, Div. 1 per NEC 503.3(A)(2)
- Class III, Div. 2 per NEC 503.3(B)
- Intrinsically Safe per NEC 504.20

- Bonding Wedge Locknuts are recommended in Hazardous Locations. See 101 Series on Page DB8.
- Long ferrule prevents pull-out and tight bend conduit "pop-out"
- Inspection windows in ferrule to ensure full engagement
- See Page GC4 for our patented Ferrule Wrench which makes ferrule installation easy.

Material/Finish:

Malleable Iron Body and Nut, Zinc Electroplated. Steel Ferrule, Zinc Electroplated.

Optional Finish:

Hot Dip or Mechanical Galvanize, add suffix "G" to catalog number. Contact your local representative for pricing and availability.

Third Party Certification:



UL Listed: E-24264



CSA Certified: 9795

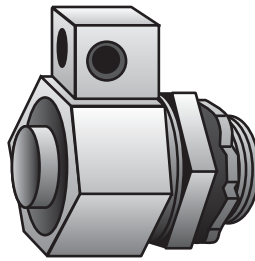

Type 4Q-38L — Type 4Q-200L

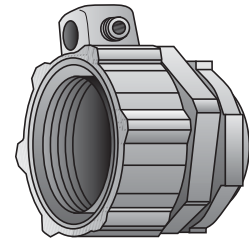

Type 4Q-250L — Type 4Q-600L

Trade Size (inches)	Catalog Number	Insulated Throat Catalog Number	Dimensions in Inches				Wire Size Min. Max.
			A	B	C	Turning Radius Gland Nut	
3/8 (1/2 KO)	4Q-38L	4Q-38LT	7/8	1/2	1 1/16	1 1/16	14 4
1/2	4Q-50L	4Q-50LT	7/8	1/2	1 1/8	1 1/8	14 4
3/4	4Q-75L	4Q-75LT	1	1/2	2 1/8	1 1/8	14 4
1	4Q-100L	4Q-100LT	1 1/8	5/8	2 3/8	1 1/8	14 4
1 1/4	4Q-125L	4Q-125LT	1 5/8	5/8	2 7/8	1 3/4	6 1/0
1 1/2	4Q-150L	4Q-150LT	1 3/4	5/8	3 1/4	1 7/8	6 1/0
2	4Q-200L	4Q-200LT	1 1/2	5/8	3 3/4	2 1/8	6 1/0
2 1/2	4Q-250L	4Q-250LT	1 15/16	1	4 5/8	2 3/4	1 4/0
3	4Q-300L	4Q-300LT	1 15/16	1 1/8	5 1/8	3 1/8	1 4/0
3 1/2	4Q-350L	4Q-350LT	2 1/8	1 1/8	5 9/16	3 3/8	1 4/0
4	4Q-400L	4Q-400LT	2 1/4	1 1/4	6 1/2	3 5/8	1 4/0
5	4Q-500L*	4Q-500LT*	2 5/8	1 1/8	7 1/2	4 1/8	1 4/0
6	4Q-600L*	4Q-600LT*	2 1/2	1 3/8	8 1/2	4 3/4	1 4/0

*UL Listing not applicable

*CSA Certification not applicable

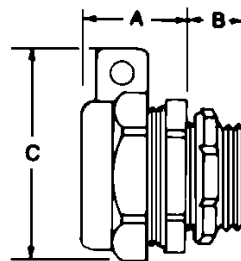

Applicable Third Party Standards:

UL Standard: 467
CSA Standard: C22.2 No. 41
NEMA: FB-1
Federal Spec: W-F-406E

Suggested Specification:

Where liquidtight flexible metal conduit is used, bonding jumpers shall be provided alongside such conduit and terminated by malleable iron connectors provided with lugs cast integrally with the gland nuts. These connectors shall be O-Z/Gedney Type 4QL.

Ground-Tite® Grounding Liquidtight Connectors

Type 4Q-L

45°

Use:

Secures, grounds and seals liquidtight flexible metal conduit and terminates bonding conductor run externally alongside liquidtight conduit.

Features:

- Positive grounding type
- Tapered threaded male hub NPT
- Grounding lug is cast as an integral part of malleable iron gland nut. Provides high ground fault withstand capability
- Compact, slim diameter with small turning radius
- Furnished with locknut and KO sealing ring.
- Liquidtight/Raintight/Oiltight/Concretetight
- UL Listed NEMA Type 4 when installed into a NPT threaded entry or UL Listed conduit hub (sizes 1¼" and larger require thread sealant).

- Suitable for use in the following Hazardous Locations:

Class I, Div. 2 per NEC 501.4(B)

Class I, Zone 2 per NEC 505.15(C)(2)

Class II, Div. 1 per NEC 502.4(A)(1)(e)

Class II, Div. 2 per NEC 502.4(B)(2)

Class III, Div. 1 per NEC 503.3(A)(2)

Class III, Div. 2 per NEC 503.3(B)

Intrinsically Safe per NEC 504.20

- Bonding Wedge Locknuts are recommended in Hazardous Locations. See 101 Series on Page DB8.

- Long ferrule prevents pull-out and tight bend conduit "pop-out"
- Inspection windows in ferrule to ensure full engagement

- See Page GC4 for our patented Ferrule Wrench which makes ferrule installation easy.

Material/Finish:

Malleable Iron Body and Nut, Zinc Electroplated. Steel Ferrule, Zinc Electroplated.

Optional Finish:

Hot Dip or Mechanical Galvanize, add suffix "G" to catalog number. Contact your local representative for pricing and availability.

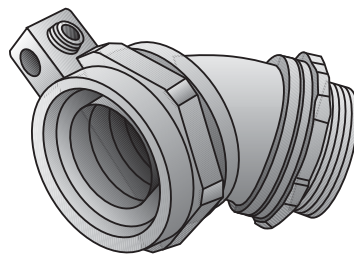

Type 4Q-438L — Type 4Q-4200L

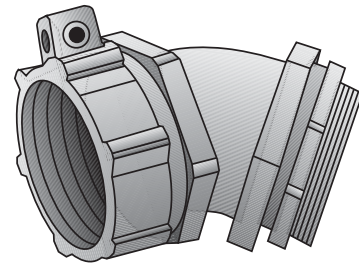

Type 4Q-4250L — Type 4Q-4500L

Trade Size (inches)	Catalog Number	Insulated Throat Catalog Number	Dimensions in Inches			Turning Radius Gland Nut	Wire Size	
			A	B	C		Min.	Max.
⅝ (½ KO)	4Q-438L	4Q-438LT	1¾	½	1⅞	1⅞	14	4
½	4Q-450L	4Q-450LT	1¾	⅞	1⅞	1⅞	14	4
¾	4Q-475L	4Q-475LT	2⅞	⅞	2⅞	1⅞	14	4
1	4Q-4100L	4Q-4100LT	3⅞	½	2⅞	1⅞	14	4
1¼	4Q-4125L	4Q-4125LT	3	⅞	2⅞	1¾	6	1/0
1½	4Q-4150L	4Q-4150LT	3⅞	⅞	3¼	1⅞	6	1/0
2	4Q-4200L	4Q-4200LT	3¾	⅞	3¼	2⅞	6	1/0
2½	4Q-4250L	4Q-4250LT	5¾	1	4⅞	2¾	1	4/0
3	4Q-4300L	4Q-4300LT	6½	1⅞	5⅞	3⅞	1	4/0
4	4Q-4400L	4Q-4400LT	7½	1⅞	6½	3⅞	1	4/0
5	4Q-4500L•	4Q-4500LT•	8	1¼	7½	4⅞	1	4/0

•UL Listing not applicable

Third Party Certification:

 UL Listed: E-24264

 CSA Certified: 9795

Suggested Specification:

Where liquidtight flexible metal conduit is used, bonding jumpers shall be provided alongside such conduit and terminated by malleable iron connectors provided with lugs cast integrally with the gland nuts. These connectors shall be O-Z/Gedney Type 4QL.

PATENTED

(All types this page)

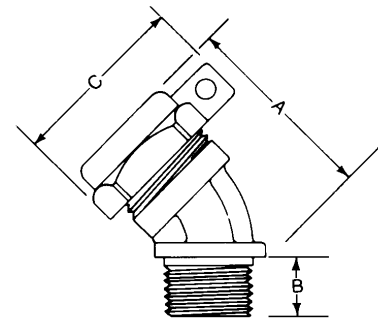

Ground-Tite® Grounding Liquidtight Connectors

Type 4Q-L

90°

Use:

Secures, grounds and seals liquidtight flexible metal conduit and terminates bonding conductor run externally alongside liquidtight conduit.

Features:

- Positive grounding type
- Tapered threaded male hub NPT
- Grounding lug is cast as an integral part of malleable iron gland nut. Provides high ground fault withstand capability
- Compact, slim diameter with small turning radius
- Furnished with locknut and KO sealing ring.
- Liquidtight/Raintight/Oiltight/Concretetight
- UL Listed NEMA Type 4 when installed into a NPT threaded entry or UL Listed conduit hub (sizes 1¼" and larger require thread sealant).
- Suitable for use in the following Hazardous Locations:
 - Class I, Div. 2 per NEC 501.4(B)
 - Class I, Zone 2 per NEC 505.15(C)(2)
 - Class II, Div. 1 per NEC 502.4(A)(1)(e)
 - Class II, Div. 2 per NEC 502.4(B)(2)
 - Class III, Div. 1 per NEC 503.3(A)(2)
 - Class III, Div. 2 per NEC 503.3(B)
- Intrinsically Safe per NEC 504.20
- Bonding Wedge Locknuts are recommended in Hazardous Locations. See 101 Series on Page DB8.
- Long ferrule prevents pull-out and tight bend conduit "pop-out"
- Inspection windows in ferrule to ensure full engagement
- See Page GC4 for our patented Ferrule Wrench which makes ferrule installation easy.

Material/Finish:

Malleable Iron Body and Nut, Zinc Electroplated. Steel Ferrule, Zinc Electroplated.

Optional Finish:

Hot Dip or Mechanical Galvanize, add suffix "G" to catalog number. Contact your local representative for pricing and availability.

Third Party Certification:



UL Listed: E-24264



CSA Certified: 9795

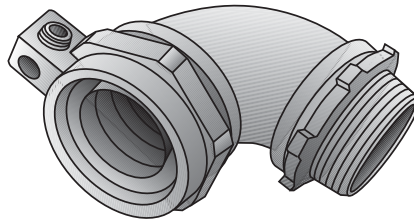

Type 4Q-938L — Type 4Q-9200L

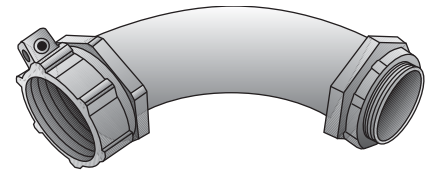

Type 4Q-9250L — Type 4Q-9500L

Trade Size (inches)	Catalog Number	Insulated Throat Catalog Number	Dimensions in Inches				Turning Radius Gland Nut	Wire Size	
			A	B	C	D		Min.	Max.
⅜ (½ KO)	4Q-938L	4Q-938LT	1⅞	½	1¼	1⅓	1⅞	14	4
½	4Q-950L	4Q-950LT	1⅞	½	1⅞	1⅞	1⅞	14	4
¾	4Q-975L	4Q-975LT	1⅞	½	1½	2⅞	1⅞	14	4
1	4Q-9100L	4Q-9100LT	1⅞	½	1⅞	2⅞	1⅞	14	4
1¼	4Q-9125L	4Q-9125LT	2⅞	⅝	2⅞	2⅞	1¾	6	1/0
1½	4Q-9150L	4Q-9150LT	2⅞	⅝	2⅞	3¼	1⅞	6	1/0
2	4Q-9200L	4Q-9200LT	3¼	¾	2⅞	3¼	2⅞	6	1/0
2½	4Q-9250L	4Q-9250LT	7⅞	1	7⅞	4⅞	2¾	1	4/0
3	4Q-9300L	4Q-9300LT	8⅞	1⅞	8½	5⅞	3⅞	1	4/0
4	4Q-9400L	4Q-9400LT	11⅞	1⅞	11	6½	3⅞	1	4/0
5	4Q-9500L•	4Q-9500LT•	16	1¼	14	7½	4⅞	1	4/0

•UL listing not applicable

Note:

When the ⅜" through 2" trade size 90° connectors are installed in enclosures with flush threaded openings (internal hubs), insufficient clearance may prevent rotation of the gland nut.

Suggested Specification:

Where liquidtight flexible metal conduit is used, bonding jumpers shall be provided alongside such conduit and terminated by malleable iron connectors provided with lugs cast integrally with the gland nuts. These connectors shall be O-Z/Gedney Type 4QL.

PATENTED

(All types this page)

