

PEDESTAL SERVICE FITTINGS FOR FLOOR BOXES AND FIRE-RATED POKE-THROUGHS

Installation Instructions

GENERAL INFORMATION

CAUTION: RISK OF ELECTRIC SHOCK. Disconnect power before installing. For installation by a qualified electrician in accordance with national and local electrical codes. Never wire energized electrical components.

CAUTION: USE ONLY IN INDOOR, DRY LOCATIONS. Suitable for use on carpeted, vinyl linoleum-covered and smooth ceramic tile-covered floors. Check that the pedestal fitting's type and rating are suitable for the application.

CAUTION: RISK OF ELECTRIC SHOCK. Do NOT install in locations where removal of portable appliances would expose the pedestal fitting to liquids POURED DIRECTLY on it during floor cleaning, such as in commercial kitchens.

CAUTION: Nonmetallic flange/cover are not intended to be used in high traffic installations and are not intended to support furniture.

NOTICE: USE ONLY CLEAR SILICONE, TYPE RTV SEALANT TO INSURE SCRUB WATER TIGHTNESS.

NOTICE: Insure data/communications circuits are separated from lighting/power circuits.

INSTALLATION INSTRUCTIONS

MULTIPLE-SERVICE-CAPABLE POKE-THROUGH PEDESTAL FITTINGS Fig. 1. FR80AL, FR280GYA, FR280BKA, FR480GYA, FR480BKA, FR680GYA, FR680BKA. NOTICE: See Underwriters Laboratories Fire Resistance Directory for complete construction and installation specifications.

These Poke-Throughs and pedestal fittings are intended for use in 1, 1½, 2, 3 or 4 hour fire-rated unprotected reinforced concrete floors Fig. 2a or in 1, 1½, 2 or 3 hour fire-rated floors employing steel form units and concrete topping (D900-Series designs) Fig. 2b or in concrete floors with suspended ceilings. (Fire resistance designs with suspended ceilings should have provisions for accessibility in the ceiling area below the poke-through fittings). The assembled Poke-Through device and pedestal fitting will not reduce the fire-ratings of the floor assembly when the thickness and type of concrete (required for a specific rating) are within the specified limits and the device is installed as specified:

- **Concrete** - Minimum thickness of structural concrete topping of 2-1/4 inches (57.1-mm) over metal deck or a minimum of 3 inches (76.2mm) thick reinforced concrete slab. Unit weight of concrete to be 113 to 155 pounds per cubic foot.
- **Spacing** - Minimum of 2 feet (0.6 m) on-center and not more than one Poke-Through unit per each 65 square feet (6 m²) of floor area in each span.
- **Concrete Installation**- For use with power circuits, data cables and maximum 50-pair-size telephone cables as tabulated below:

TABLE 1

Poke-Through Cat. No.	Pedestal Fitting Cat. No.	Power Conductors(a)	Phone/Data Conductors(b)
PT7XC	FR80AL	9	200
PT7XC	FR280 series	9	200
PT7XC	FR480 series	9	200
PT7XC	FR680 series	9	200
PT27A	FR280 series	9	100
PT27A	FR480 series	9	100
PT27A	FR680 series	9	100

- (a) Maximum number of 12 AWG Type THHN conductors in the power compartment of poke-through fitting in addition to integral ground.
 (b) Maximum number of 22 AWG conductors in the low-voltage compartment of poke-through fitting (25-pair telephone cable has 50 conductors). When conductors larger than 22 AWG are used, the aggregate cross-sectional area of the copper conductors shall not exceed the aggregate cross-sectional area of 22 AWG copper conductors permitted in the low-voltage compartment.

Fig. 2d

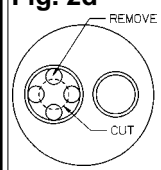

1. Core drill a 2 inch (50-mm) (PT27A) or 3 inch (76-mm) (PT7XC) diameter hole through the concrete floor.
2. Before inserting PT27A or PT7XC into hole, set the adjustable lower fire barrier to floor thickness dimension "Y". Fig. 2.
3. Insert PT27A or PT7XC into hole. Orient voice/data and power/lighting. Push down until abandonment plate is flush with the floor. Fig. 2c.
4. To activate the PT27A or PT7XC remove abandonment plate and replace with one of the pedestal from Table 2. (See next page.)

Notice: For PT7XC cut fire barrier in four places and remove center slugs. Fig. 2d. All FR series pedestal fittings must be fastened to the floor using ¼ inch (6.4 mm) anchors and #10 screws (not provided). Use pedestal fitting base(s) A as a template

and drill two, four or six ¼ inch (6.4-mm) diameter holes in the concrete floor approximately 1 inch (25 mm) deep. Install plastic or lead anchors (not provided).

5. Use provided gasket M or apply a ¼ inch (6.3-mm) thick, continuous bead of sealant compound H (see NOTICE) fully around the perimeter on the underside of plate I. (See Fig. 1.) Place the pedestal over the Poke-Through and fasten to the

Fig. 1

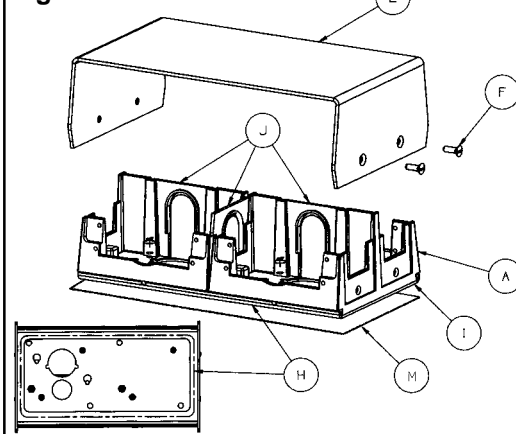
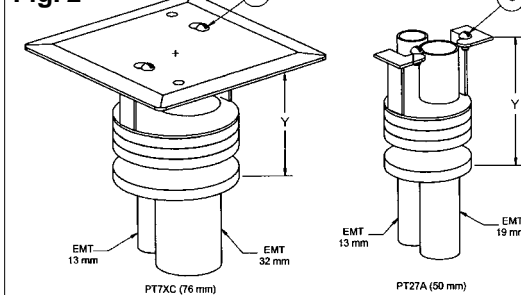

Fig. 2



5. Use provided gasket M or apply a ¼ inch (6.3-mm) thick, continuous bead of sealant compound H (see NOTICE) fully around the perimeter on the underside of plate I. (See Fig. 1.) Place the pedestal over the Poke-Through and fasten to the

6. Install receptacle(s) or data/communications outlet(s) to base A (see NOTICE) by first removing from the receptacle(s) or communications outlet(s) any auxiliary grounding clips, fiber washers and plaster ears. Follow device manufacturer's installation instructions. 7. Use appropriate Hubbell faceplates D (not provided) shown in Table 2 and Fig. 3 (on next page) Securely fasten each faceplates D with the two 6-32 screws provided with the faceplates.

8. Securely fasten cover E to the pedestal fitting base A with screws F (provided).

Notice: Carpet cutout should be 4-3/8 x 4-3/8 inches (111 x 111 mm) for FR80AL, 4-1/2 x 4-1/2 inches (114 x 114 mm) for FR280-series, 4-3/4 x 9 inches (121 x 229 mm) for FR480-series and 4-3/4 x 13-3/8 inches (121 x 340 mm) for FR680-series. "LO-CON®" SINGLE-SERVICE PEDESTAL FITTINGS Fig. 4 (See next page.) SC3098A (3/4" nipple), SC3099A (1" nipple) Intended for mounting on Hubbell floor box covers tabulated in Table 2 (See next page) or on underfloor deck/duct systems having threaded openings for ¾" or 1" Nipples. 1. Securely fasten base A with gasket M to the threaded opening of floor box-cover or underfloor deck/duct using the ¾" or 1" Nipple B (provided). 2. Lock unit against rotation by tightening setscrew C. 3. See steps 7 and 8 from MULTIPLE-SERVICE

PEDESTAL instructions. see fig. 4. **Notice:** Hubbell blank faceplate SS309BF or SS309B (not provided) must enclose any unused side of pedestal.

Fig. 2c

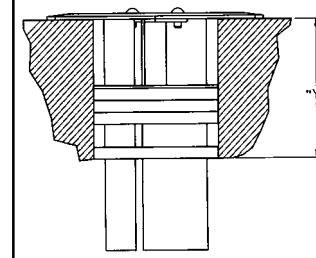
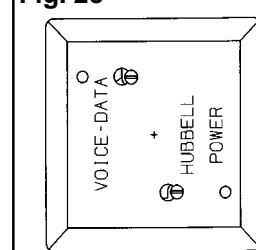
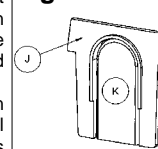

Fig. 5



next page). 6. Install receptacle(s) or data/communications outlet(s) to base A (see NOTICE) by first removing from the receptacle(s) or communications outlet(s) any auxiliary grounding clips, fiber washers and plaster ears. Follow device manufacturer's installation instructions. 7. Use appropriate Hubbell faceplates



TABLE 2

PEDESTAL (Fig. 1) (Fig. 4)	BOX COVERS	POKE-THROUGH (Fig. 2)	FACEPLATES (Fig. 3)
CATALOG NUMBER SC3098A SC3099A	S2425, SA2425, S2625 SA2625, S2525, SA2525 S2725, SA2725, SF2725 SF2525		SS309DS, SS309D, SS309S, SS309T SS309SF, SS309SF1, SS309BF, SS309B
FR80AL		PT7XC	
FR280 FR480 FR680		PT7XC or PT27A	SS2309DGYA, SS2309DBKA, SS2309SGYA, SS2309SBKA, SS2309BGYA, SS2309FBKA, SS2309TGYA, SS2309TBKA, SS2309SLGYA, SS2309SLBKA, SS2309F1GYA, SS2309F1BKA, SS2309BBKA

Fig. 3

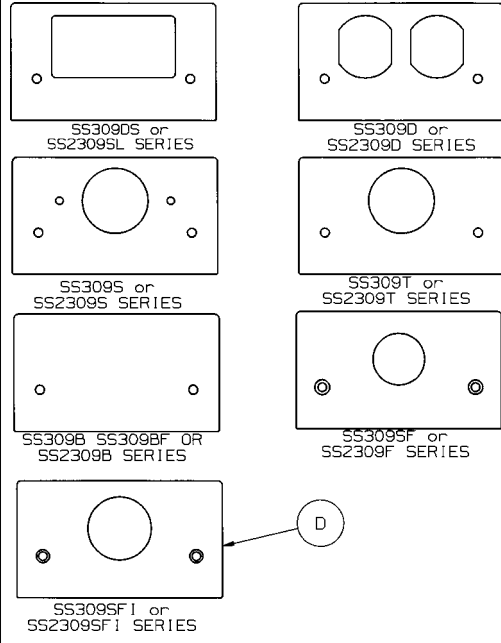

Fig. 6

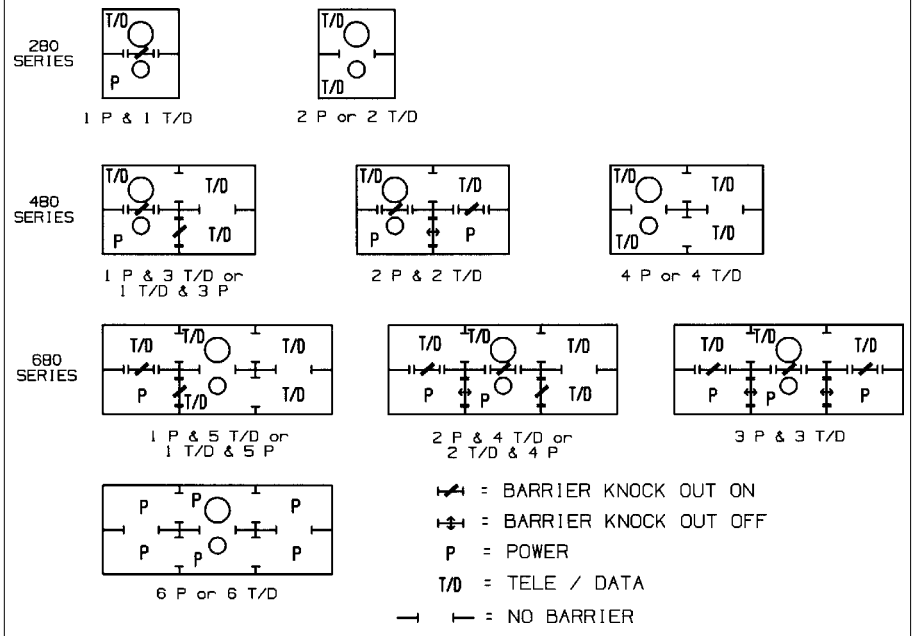

Fig. 4

