

M18T T-Gage Sensor

18 mm sensor with discrete output and TEACH-mode programming

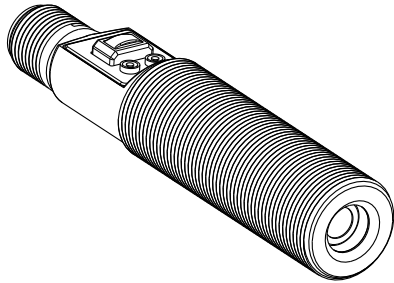

Features



- Fast 25 ms response time (up to 20 Hz switching speed)
- Easy-to-use TEACH mode programming; no potentiometer adjustments
- Small self-contained package, no auxiliary controller needed
- Rugged encapsulated design for harsh environments
- Choose 2 meter or 9 meter unterminated cable, or 5-pin Euro-style QD connector
- Product motion not required for sensing
- Remote Teach available in both Static and Dynamic modes



Models

Model	Cable*	D:S Ratio	Sensing Face	Supply Voltage	Output
M18TB8	5-wire, 2 m (6.5') shielded cable	8:1	Integrated lens	10 to 30V dc	Bipolar (NPN and PNP)
M18TB8Q	5-pin Euro-style integral QD				
M18TB6E	5-wire, 2 m (6.5') shielded cable	6:1	Enclosed Plastic face (for food industry use)		
M18TB6EQ	5-pin, Euro-style integral QD				
M18TB14	5-wire, 2 m (6.5') shielded cable	14:1	Germanium lens		
M18TB14Q	5-pin, Euro-style integral QD				

* For 9 m (30') cable, add suffix "W/30" to the model number of any cabled model (e.g., **M18TB8 W/30**). A model with a QD connector requires an accessory mating cable. See PAGE 7 for more information.



WARNING: Not To Be Used for Personnel Protection

Never use this product as a sensing device for personnel protection. Doing so could lead to serious injury or death. This product does NOT include the self-checking redundant circuitry necessary to allow its use in personnel safety applications. A sensor failure or malfunction can cause either an energized or de-energized sensor output condition.



Overview

The T-GAGE analog sensor is a passive, non-contacting, temperature-based device. It is used to detect object(s) that are either hotter or colder than the ambient condition, and then activate an output.

While it looks and operates just like an Expert™ photoelectric sensor, the T-GAGE detects the infrared light energy emitted by objects, instead of its own emitted light. The sensor uses a thermopile detector, made up of multiple infrared-sensitive elements (thermocouples) to detect this infrared energy within its field of view (see Figure 2).

Potential applications include:

- Hot part detection (baked goods, metals, bottles)
- Ejection verification of injection-molded parts
- Flame process verification
- Hot glue detection (packaging equipment, book binding, product assembly)
- Cold part detection (frozen foods, ice, dairy)
- Roller monitoring



NOTE: The T-GAGE M18T sensor is not intended for absolute temperature measurement or for safety-related fire detection use.

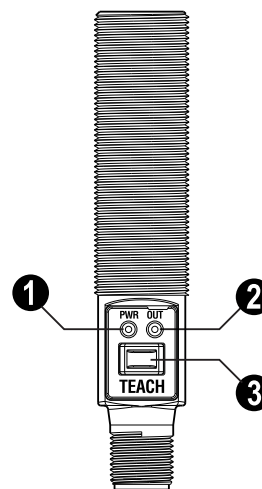
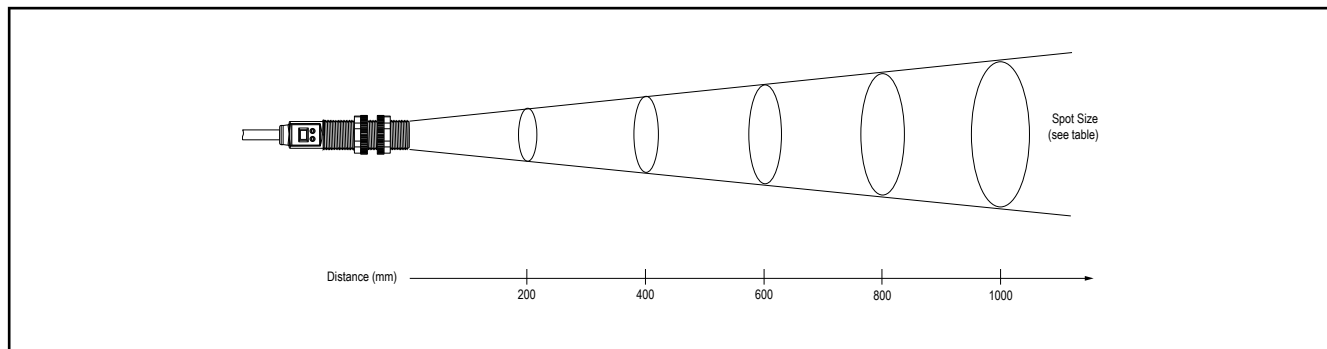

Figure 1. Sensor Features

1	Power/Teach LED
2	Alarm Output LED
3	TEACH Push Button

Sensing Field of View

The sensing range is determined by the sensor's field of view (FOV), or viewing angle, combined with the size of the object(s) being detected (see Figure 2). The sensor's distance-to-spot size ratio (D:S ratio) is inversely related to the viewing angle; a sensor with a small viewing angle will have a large D:S ratio. The T-GAGE M18T sensors have D:S ratios of 6:1, 8:1 or 14:1. For a sensor with an 8:1 D:S ratio, the sensor's spot size is a 1" diameter circle at a distance of 8"; farther from the sensor face the spot size will be larger.



Sensor D:S Ratio	Distance from Sensor Face Versus Spot Size										Distance (mm)
	100	200	300	400	500	600	700	800	900	1000	
6:1	17	33	50	67	83	100	117	133	150	167	Spot Size (mm)
8:1	13	25	38	50	63	75	88	100	113	125	
14:1	7	14	21	29	36	43	50	57	64	71	

Figure 2. Detection spot size versus distance from sensor

Apparent Temperature

Two factors that have a large influence on apparent temperature are the object's *emissivity* and whether or not the object fills the sensor's field of view.

Object Emissivity:

A "blackbody" is a "perfect" emitter, with an emissivity of 1.0 at all temperatures and wavelengths. Most surfaces emit only a fraction of the amount of thermal energy that a blackbody would. Typical T-GAGE applications will be sensing objects with emissivities ranging from 0.5 to 0.95. Many references are available with tables of emissivity coefficients for common materials. In general, shiny unpainted metals have low emissivity, while non-glossy surfaces have high emissivity.

Shiny surfaces: a mirror or shiny surface can redirect an object's emitted energy to an undesired location, or even bring additional unintended thermal energy into the sensor's field of view (see [Application Note](#) on page 6).

Object Size:

If the object being detected does not fill the sensor's field of view, then the sensor will average the temperature of that object and whatever else is in the sensing field of view. For the sensor to collect the maximum amount of energy, the object should completely fill the sensor's field of view. However, in some applications, when the object is too small, this may not be possible. In such cases, if the object is hot enough, the thermal contrast may still be adequate to trigger the sensor's output.

Sensor Programming

Two TEACH methods may be used to program the sensor:

- Teach individual minimum and maximum limits (Two-Point Static Teach), or
- Dynamic Teach for on-the-fly programming.

The sensor may be programmed either via its push button, or via a remote switch. Remote programming also may be used to disable the push button, preventing unauthorized personnel from adjusting the programming settings. To access this feature, connect a normally open switch between the sensor's gray wire and dc common or connect the gray wire to a digital input (PLC).



NOTE: The impedance of the Remote Teach input is 3 kΩ.

Programming is accomplished by following the sequence of input pulses (see [Teaching Limits Using Two-Point Static TEACH](#) on page 4). The duration of each pulse (corresponding to a push button "click"), and the period between multiple pulses, are defined as "T":

$$0.04 \text{ seconds} < T < 0.8 \text{ seconds}$$

Status Indicators

Power ON/ OFF LED	Indicates	Output LED	Indicates
OFF	Power is OFF	OFF	Run Mode: Output is OFF TEACH Mode: Waiting for Output OFF condition
ON Green	Sensor is in Run mode	ON Yellow	Run Mode: Output is energized TEACH Mode: Waiting for Output ON condition
ON Red	TEACH is active	Flashing Yellow	Dynamic TEACH active

Teaching Limits Using Two-Point Static TEACH

Two-Point TEACH is the traditional setup method, used when two conditions can be presented individually by the user. The sensor establishes a single sensing threshold (the switchpoint) midway between the two taught conditions, with the Output ON condition on one side and the Output OFF condition on the other.

General Notes on Programming

- The sensor will return to RUN mode if the first TEACH condition is not registered within 60 seconds
- After the first limit is taught, the sensor will remain in PROGRAM mode until the TEACH sequence is finished

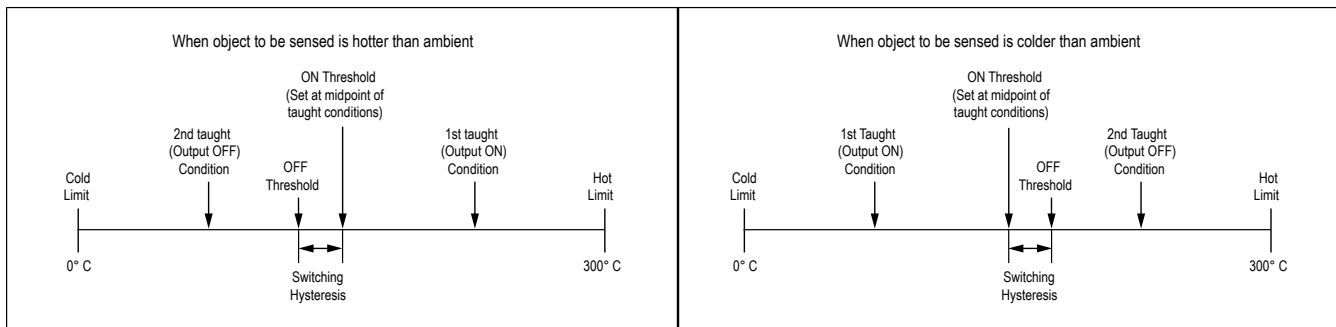

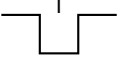

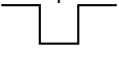

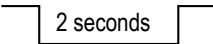

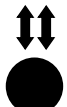
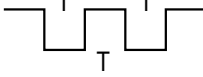

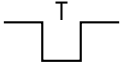

Figure 3. Two-Point Static Teach

	Two-Point TEACH Procedure		Result
	Push Button	Remote Line (0.04 sec < T < 0.8 sec)	
Programming Mode	<ul style="list-style-type: none"> • Push and hold push button for 2 seconds 	No action required	<ul style="list-style-type: none"> • Power LED turns Red • Output LED turns Yellow
Learn Output ON Condition	<ul style="list-style-type: none"> • Present Output ON condition • "Click" the push button 	<ul style="list-style-type: none"> • Present Output ON condition • Single-pulse the remote line 	<ul style="list-style-type: none"> • Output LED turns OFF
Learn Output OFF Condition	<ul style="list-style-type: none"> • Present Output OFF condition • "Click" the push button 	<ul style="list-style-type: none"> • Present Output OFF condition • Single-pulse the remote line 	<p>Teach Accepted</p> <ul style="list-style-type: none"> • Power LED turns Green • Sensor automatically sets the switching threshold and returns to Run mode <p>Teach Unacceptable Sensor returns to beginning of Teach</p>
Exit Without Save	<ul style="list-style-type: none"> • Push and hold push button for 2 seconds 	<ul style="list-style-type: none"> • Hold remote line low for 2 seconds 	Sensor returns to Run mode without saving new settings

Teaching Limits Using Dynamic TEACH

Dynamic TEACH is a method of setting the sensor's threshold while the application is active. Dynamic TEACH will sense the high and low temperature limits of the process and automatically set the threshold at the midpoint between these limits.

	Dynamic TEACH Procedure		Result
	Push Button	Remote Line (0.04 sec < T < 0.8 sec)	
Programming Mode	<ul style="list-style-type: none"> Push and hold push button for 2 seconds 	No action required	<ul style="list-style-type: none"> Power LED turns Red Output LED turns Yellow
Enter Dynamic TEACH Process	<ul style="list-style-type: none"> "Double-click" the push button 	<ul style="list-style-type: none"> Double-pulse the remote line 	<ul style="list-style-type: none"> Sensor begins dynamic learning process Output LED flashes Yellow @ 2 Hz
End Dynamic TEACH Process	<ul style="list-style-type: none"> "Single-click" the push button 	<ul style="list-style-type: none"> Single-pulse the remote line 	<ul style="list-style-type: none"> Sensor ends data collection; sets threshold Power LED turns Green Sensor returns to Run mode

Hot Operate/Cold Operate Select

The sensor can be configured for either Hot Operate or Cold Operate via the remote teach wire (gray). A series of three pulses on the line will toggle between Hot and Cold Operation.

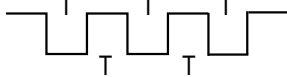
	Procedure		Result
	Push Button	Remote Line (0.04 sec < T < 0.8 sec)	
Toggle Between Hot Operate / Cold Operate	<ul style="list-style-type: none"> Not available via push button 	<ul style="list-style-type: none"> Three-pulse the remote line 	<ul style="list-style-type: none"> Either Hot Operate or Cold Operate is selected, depending on previous condition

Push Button Lockout

The push button lockout feature enables or disables the push button to prevent unauthorized adjustment of the program settings.

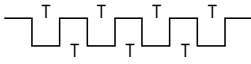
	Procedure		Result
	Push Button	Remote Line (0.04 sec < T < 0.8 sec)	
Push Button Lockout	Not available via push button	<ul style="list-style-type: none"> Four-pulse the remote line 	<ul style="list-style-type: none"> Push button is either enabled or disabled, depending on previous condition

Installation Notes

Align the sensor toward the object to be detected. Visually align if possible, or use the alignment device accessory listed in [Additional Accessories](#) on page 9.

Specifications

Temperature Measurement Range

0° to 300° C (32° to 572° F) standard;
custom ranges available

Sensing Range

Depends on object size and sensing field of view (see [Sensing Field of View](#) on page 2)

Wavelength

8 to 14 μm

Distance to Spot Size (D:S) Ratio

6:1, 8:1, or 14:1, depending on model

Supply Voltage

10 to 30V dc (10% maximum ripple)
35 mA max (exclusive of load)

Output Configuration

One NPN (current sinking) and one PNP (current sourcing) in each model

Output Protection

Protected against short circuit conditions

Output Ratings

100 mA maximum (each output)

OFF-state leakage current: NPN < 200 microamps;
PNP < 10 microamps

NPN saturation: < 200 mV @ 10 mA and < 1V @ 100 mA

PNP saturation: < 1.2 V @ 10 mA and < 1.6V @ 100 mA

Delay at Power-Up

1.5 seconds

Output Response Time

25 ms

Repeatability (Relative)

1° C

Minimum Taught Differential

3° C

Hysteresis

5% of taught differential (minimum 1° C)

Adjustments

TEACH-Mode programming

Indicators

One bicolor (Green/Red) status LED, one Yellow LED (see [Status Indicators](#) on page 3)

Remote Teach Input

Impedance: 3 k Ω

Construction

Threaded Barrel: 304 stainless steel

Push Button Housing: ABS/PC

Push Button: Santoprene

Lightpipes: Acrylic

Operating Conditions

Temperature: -20° to +70° C (-4° to 158° F)

Environmental Rating

Leakproof design is rated IEC IP67; NEMA 6

Temperature Warm-Up Time

5 minutes

Certifications



Application Note

Following are examples of materials with high and low emissivity. (Many more examples can be found in sources such as the Internet.)

Sensor-Friendly Materials (High Emissivity)

- Aluminum - anodized
- Asphalt
- Brick
- Carbon - lampblack or plate material
- Cardboard - corrugated or chipboard
- Concrete
- Glass - smooth, lead, or borosilicate (e.g., Pyrex®)
- Gypsum (including finished boards)
- Ice
- Iron and steel (except bright galvanized)
- Paper - most types, regardless of color
- Styrofoam® insulation
- Plastics
- Water
- Wood - most types

Materials to Sense with Caution (Low Emissivity - Test, Test, Test!)

- Aluminum - plain or highly polished
- Copper
- Galvanized iron
- Stainless steel
- Vapor-deposited materials

Dimensions

Cabled Models

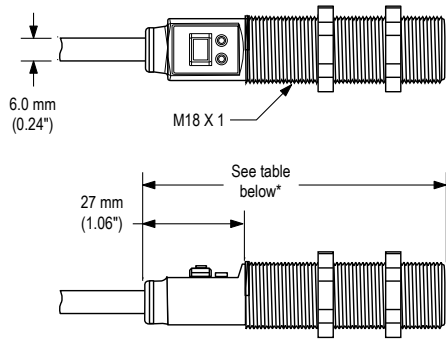

*Overall Length	
Model M18T..8	81.2 mm (3.20")
Model M18T..6E	81.7 mm (3.22")
Model M18T..14	86.5 mm (3.41")

QD Models

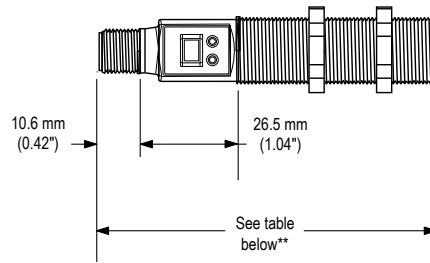

**Overall Length	
Model M18T..8Q	91.3 mm (3.59")
Model M18T..6EQ	91.8 mm (3.61")
Model M18T..14Q	96.6 mm (3.80")

Hookups

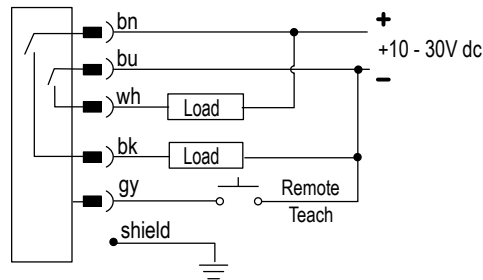

Cable and QD hookups are functionally identical.



NOTE: It is recommended that the shield wire be connected to earth ground or dc common. Shielded cord-sets are recommended for all QD models.

Accessories

Quick-Disconnect Cables

Style	Model	Length	Dimensions	Pinout
5-pin Euro-style straight, with shield	MQDEC2-506	2 m (6.5')		<p>1 = Brown 2 = White 3 = Blue 4 = Black 5 = Gray</p>
	MQDEC2-515	5 m (15')		
	MQDEC2-530	9 m (30')		
5-pin Euro-style right-angle, with shield	MQDEC2-506RA	2 m (6.5')		
	MQDEC2-515RA	5 m (15')		
	MQDEC2-530RA	9 m (30')		

Accessory Mounting Brackets

Model	Description	
SMB18A	<ul style="list-style-type: none"> • 12-gauge, stainless steel, right-angle mounting bracket with a curved mounting slot for versatility and orientation • Clearance for M4 (#8) hardware 	
SMB18SF	<ul style="list-style-type: none"> • 18 mm swivel bracket • Black thermoplastic polyester • Includes stainless steel hardware 	
SMB18UR	<ul style="list-style-type: none"> • 2-piece universal 18 mm swivel bracket • 300 series stainless steel • Includes stainless steel swivel locking hardware 	

Additional Accessories

Laser Alignment Tool LAT1812

- Enables easy sensor alignment at long distances.
- Kit includes one SMB1812 bracket and M12 laser emitter.
- Thread bracket housing onto barrel of mounted sensor; M12 laser emitter inserted into housing provides a precise laser spot for aiming temperature sensor. (Refer to Banner data sheet p/n 122529 for more information.)
- Remove laser emitter before using sensor.



Banner Engineering Corp Limited Warranty

Banner Engineering Corp. warrants its products to be free from defects in material and workmanship for one year following the date of shipment. Banner Engineering Corp. will repair or replace, free of charge, any product of its manufacture which, at the time it is returned to the factory, is found to have been defective during the warranty period. This warranty does not cover damage or liability for misuse, abuse, or the improper application or installation of the Banner product.

THIS LIMITED WARRANTY IS EXCLUSIVE AND IN LIEU OF ALL OTHER WARRANTIES WHETHER EXPRESS OR IMPLIED (INCLUDING, WITHOUT LIMITATION, ANY WARRANTY OF MERCHANTABILITY OR FITNESS FOR A PARTICULAR PURPOSE), AND WHETHER ARISING UNDER COURSE OF PERFORMANCE, COURSE OF DEALING OR TRADE USAGE.

This Warranty is exclusive and limited to repair or, at the discretion of Banner Engineering Corp., replacement. **IN NO EVENT SHALL BANNER ENGINEERING CORP. BE LIABLE TO BUYER OR ANY OTHER PERSON OR ENTITY FOR ANY EXTRA COSTS, EXPENSES, LOSSES, LOSS OF PROFITS, OR ANY INCIDENTAL, CONSEQUENTIAL OR SPECIAL DAMAGES RESULTING FROM ANY PRODUCT DEFECT OR FROM THE USE OR INABILITY TO USE THE PRODUCT, WHETHER ARISING IN CONTRACT OR WARRANTY, STATUTE, TORT, STRICT LIABILITY, NEGLIGENCE, OR OTHERWISE.**

Banner Engineering Corp. reserves the right to change, modify or improve the design of the product without assuming any obligations or liabilities relating to any product previously manufactured by Banner Engineering Corp.