

Floor Boxes

SystemOne Recessed 2 Gang Floor Box Cover

For Use In Raised Access and Wood Floors

HUBBELL

Features

- 180 degree cover opening to lay flat and reduce tripping hazards
- Two large cable egress doors
- Die cast aluminum cover construction for enhanced durability
- ADA Compliant

Ordering Information

- Compatible with AFB2G25 and AFB2G50
- Rectangular style typical applications: Raised Floors, Wood Floors

Catalog Number 2GAFBCVRBK	UPC Number 783585446257	Style Raised Access / Wood	Finish Black Powder Coat
Dimensions 8-3/4 x 14-15/16 in.	Floor Finish Insert No		

Specifications

Cover Material	Aluminum
Flange height	0.25 in.
Adjustment Range	0 - 1.0 inch
Load Rating	800 lbs. (w/ 2x safety factor)

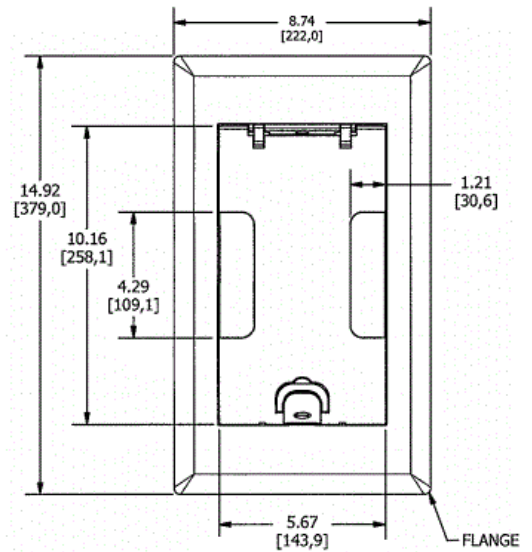

Online Resources

[Customer Use Drawing](#)
[eCatalog](#)
[Installation Instructions](#)

Dimensions in Inches (mm)

Hubbell Wiring Device-Kellems • Hubbell Incorporated (Delaware) • 40 Waterview Drive • Shelton, CT 06484

Phone (800) 288-6000 • Fax (800) 255-1031 • Specifications subject to change without notice.

