

**STRUCTURED MEDIA® CENTERS**

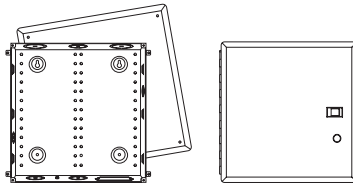

14" Series

**14" Series (14"x14.38"x3.60")**

14" Structured Media Center (Enclosure & Flush Mount Cover)	47605-140
14" Structured Media Center (Enclosure Only)	47605-14E
14" Structured Media Center (Enclosure Only, Job Packed, 6 per pack)	47605-14G
Flush Cover Only for 14" Structured Media Center (Job Packed, 6 per pack)	47605-14B
Flush Mount Cover for 14" Structured Media Center	47605-14C
Hinged Cover for 14" Structured Media Center	47605-14D
Premium Hinged Cover for 14" Structured Media Center	47605-14P
Add-on Lock and Key	5L000-L0K

*This 14" professional-grade whole-house media enclosure creates one distribution point in the home for all low voltage cables. Ideal for condos and MDUs, or more modest homes requiring basic voice/data/audio/video distribution.*

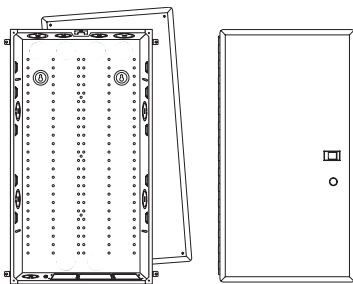

28" Series

**28" Series (28"x14.38"x3.60")**

28" Structured Media Center (Enclosure & Flush Mount Cover)	47605-28W
28" Structured Media Center (Enclosure Only)	47605-28N
28" Structured Media Center (Enclosure Only, Job Packed, 3 per pack)	47605-28G
Flush Cover Only for 28" Structured Media Center (Job Packed, 3 per pack)	47605-28B
Flush Mount Cover for 28" Structured Media Center	47605-F28
Hinged Cover for 28" Structured Media Center	47605-28D
Premium Hinged Cover for 28" Structured Media Center	47605-28P
Add-on Lock and Key	5L000-L0K

*This 28" high unit serves as command central for a variety of voice/data/audio/video distribution modules (found on the following pages), including modules for: home networking, fax, Internet, multi-line telephones, security camera, coaxial cable and satellite video distribution, speaker and volume controls.*

*The 28" Series enclosure is ideal for homes with more advanced multimedia needs, or in providing for future growth.*

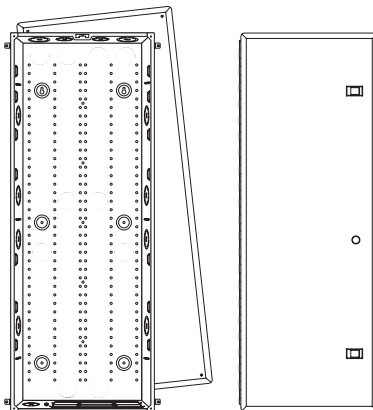

42" Series

**42" Series (42"x14.38"x3.60")**

42" Structured Media Center (Enclosure & Flush Mount Cover)	47605-42W
42" Structured Media Center (Enclosure Only)	47605-42N
Flush Mount Cover for 42" Structured Media Center	47605-F42
Hinged Cover for 42" Structured Media Center	47605-42D
Premium Hinged Cover for 42" Structured Media Center	47605-42P
Add-on Lock and Key	5L000-L0K

*The 42" Series Enclosure is extra long for larger homes or small businesses with more extensive voice/data/audio/video requirements, and to provide maximum room for expansion.*

*Accommodates an even wider variety of voice/data/audio/video distribution modules (found on the following pages), including modules for: home networking, fax, Internet, multi-line telephones, security camera, coaxial cable and satellite video distribution, speaker and volume controls.*

**STRUCTURED MEDIA® CENTERS**

**CONFIGURATION A**

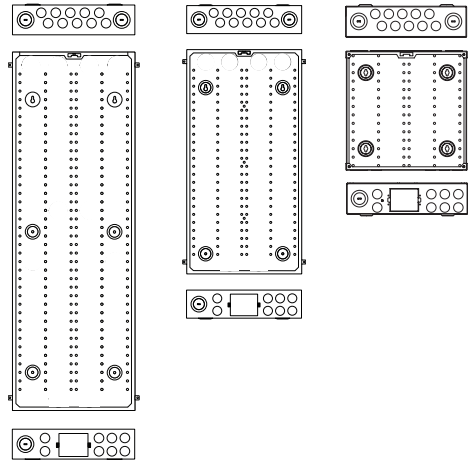

42" Multi-Dwelling Unit SMC Configuration A w/ flush mount cover	47605-4MG
28" Multi-Dwelling Unit SMC Configuration A w/ flush mount cover	47605-2MG
14" Multi-Dwelling Unit SMC Configuration A w/ flush mount cover	47605-1MG

**CONFIGURATION B**

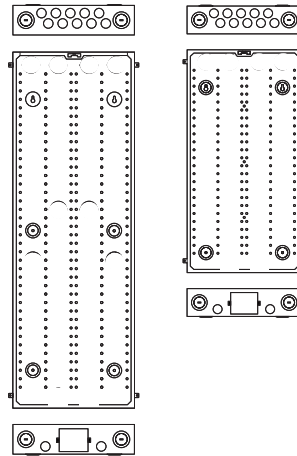

42" Multi-Dwelling Unit SMC Configuration B enclosure only	47605-M42
28" Multi-Dwelling Unit SMC Configuration B enclosure only	47605-M28

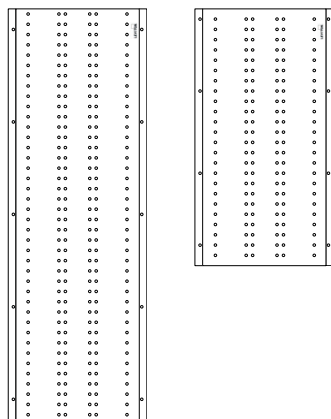

**SMC Back Plates**

42" Structured Media Center Pre-Fab Back Plate	47605-4BP
28" Structured Media Center Pre-Fab Back Plate	47605-2BP

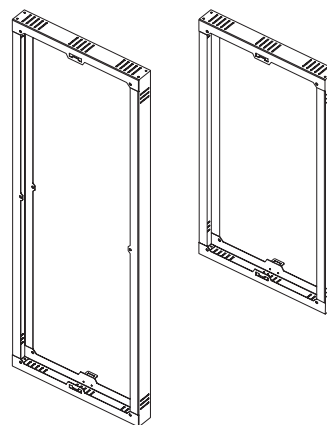

**SMC Extender Brackets**

42" Structured Media Center Extender Bracket	47612-42B
28" Structured Media Center Extender Bracket	47612-28B

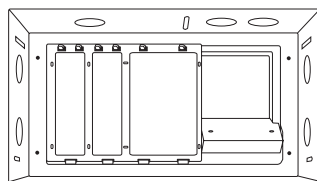

**Compact Structured Media Enclosure for MDUs**

Compact Structured Media Enclosure Empty (Shown)	47605-MDU
Compact Structured Media Enclosure and Cover plus 1X6 Telephone Expansion Board	47604-0F6
Compact Structured Media Enclosure and Cover plus 1X6 Telephone Expansion Board and 6-way Video Splitter	47604-F6S

PRE-CONFIGURED STRUCTURED CABLING PANELS

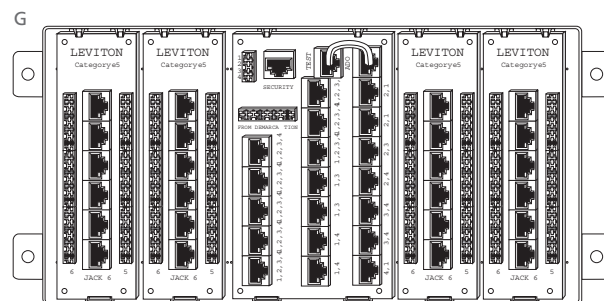
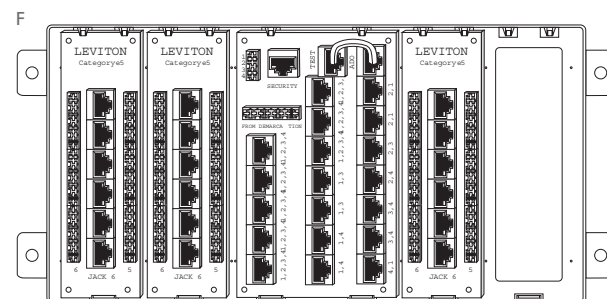
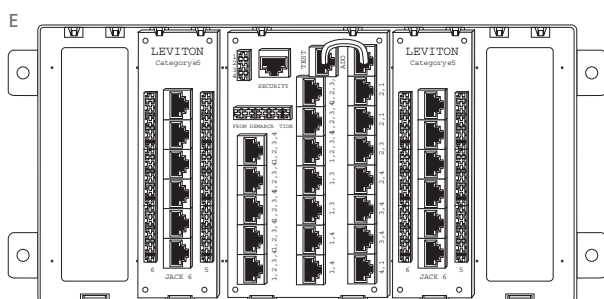
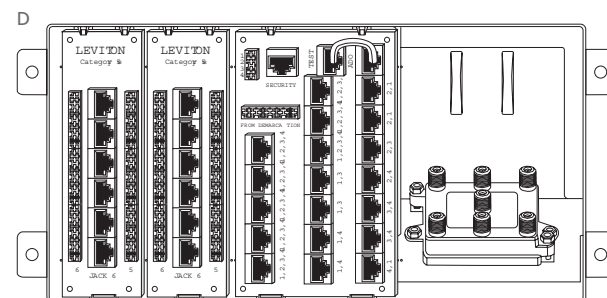
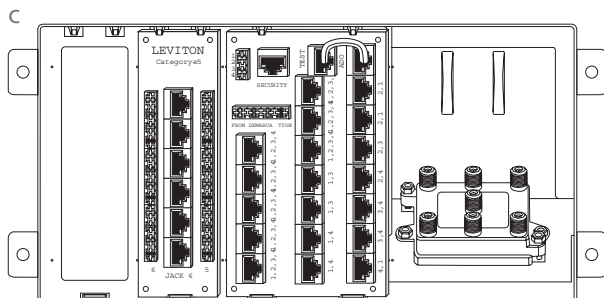
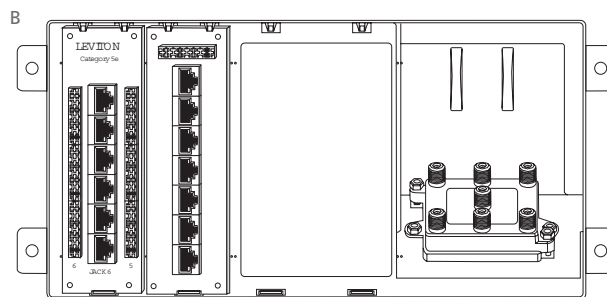
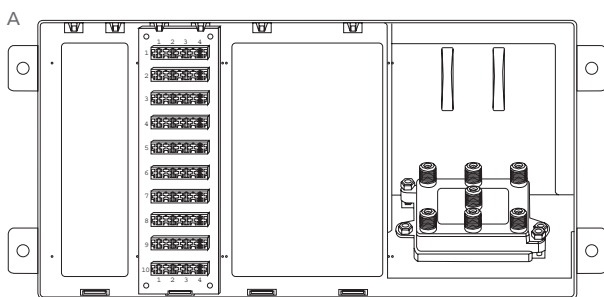

- [ A ] Basic Telephone & Video Panel (BTV) 47606-BTV
- [ B ] Basic Home Networking Plus Panel (BNP) 47606-BNP
- [ C ] Advanced Home Telephone & Video Panel (AHT) 47606-AHT
- [ D ] Advanced Small Office Telephone & Video Panel (ASO) 47606-ASO
- [ E ] 12-Port Structured Media Panel (12P) 47603-12P
- [ F ] 18-Port Structured Media Panel (18P) 47603-18P
- [ G ] 24-Port Structured Media Panel (24P) 47603-24P

**PRE-CONFIGURED STRUCTURED CABLING PANELS, (continued)**

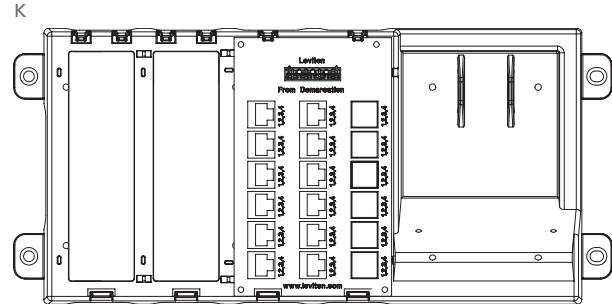
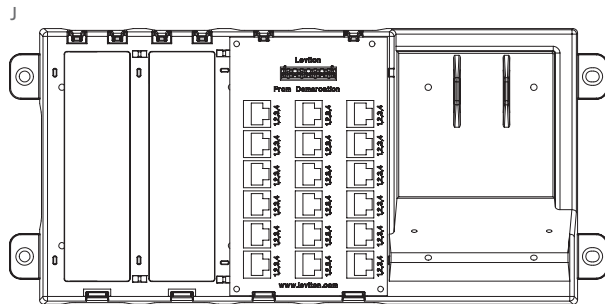
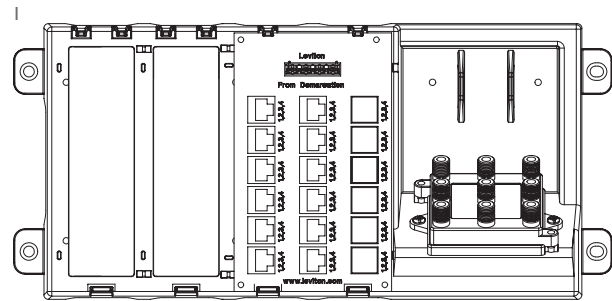
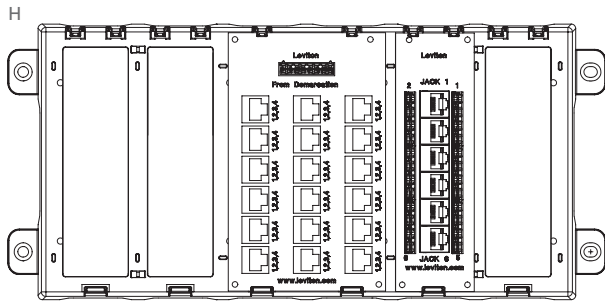

[ H ] 4x18 Telephone Distribution Panel with CAT 5e Voice and Board 47603-8C1

[ J ] 4x18 Telephone Distribution Board on Shelf Bracket 47603-18M

[ I ] 4x12 Telephone Distribution Panel with 8-Way Splitter 47603-412

[ K ] 4x12 Telephone Distribution Board on Shelf Bracket 47603-12M

**COMPACT SERIES PRE-CONFIGURED STRUCTURED CABLING PANELS**

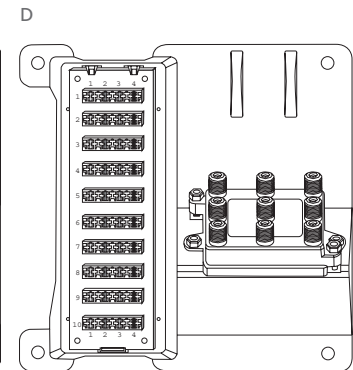
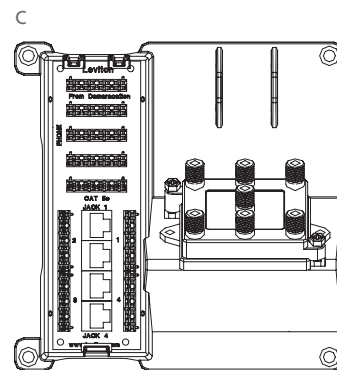
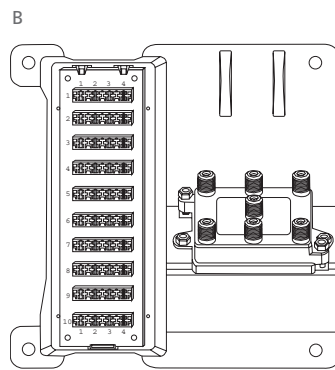
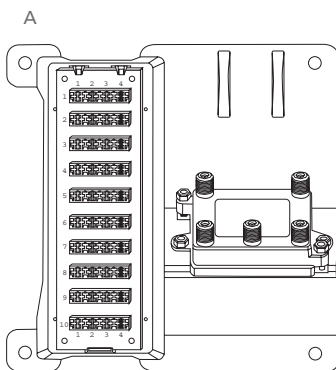

[ A ] Telephone & 4-way Video 47603-1G4

[ C ] 4 Telephone, 4 Data & 6-way Video 47603-DP6

[ B ] Telephone & 6-way Video 47603-1G6

[ D ] Telephone & 8-Way Video 47603-1G8

**LOW PROFILE/HIGH DENSITY INTERCONNECT PANELS**

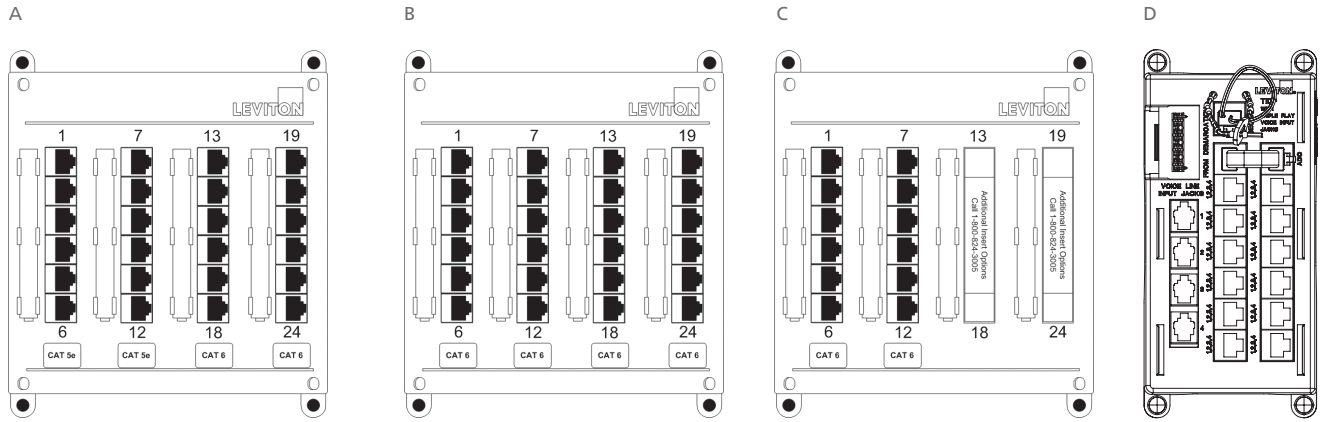

[ A ] CAT 6/ CAT 5e Twist & Mount Patch Panel, 12 CAT 6 and 12 CAT 5e connectors, cULus	476TM-654	CAT 6/CAT 5e Twist & Mount Patch Panel, 6 CAT 6 and 6 CAT 5e connectors, cULus	476TM-652
[ B ] CAT 6 Twist & Mount Patch Panel, 24 CAT 6 connectors, cULus	476TM-624	[ C ] CAT 6 Twist & Mount Patch Panel, 12 CAT 6 connectors, cULus	476TM-612
CAT 5e Twist & Mount Patch Panel, 24 CAT 5e connectors, cULus	476TM-524	CAT 5e Twist & Mount Patch Panel, 12 CAT 5e connectors, cULus	476TM-512
		[ D ] Telephone Input Distribution Panel (TIDP), cULus	476TL-T12

**MOUNTING BRACKETS FOR LEVITON STRUCTURED MEDIA CENTERS**

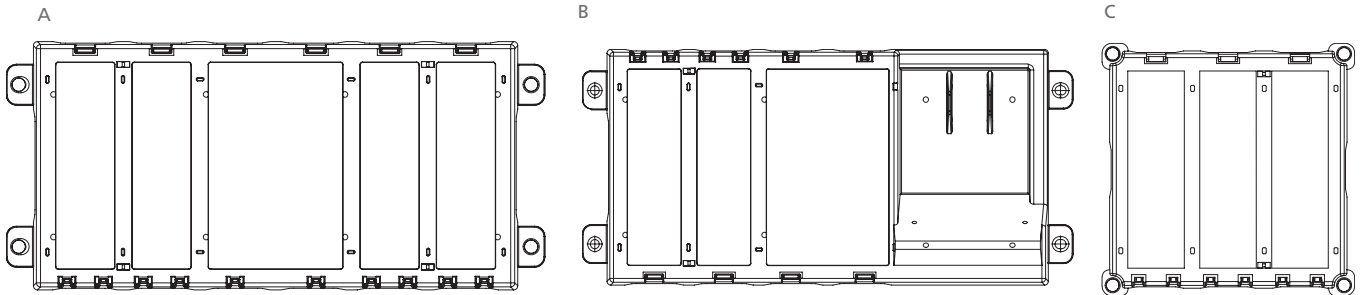

[ A ] Expansion Plastic Bracket	47612-EBK
[ B ] Shelf Plastic Bracket	47612-VSB
[ C ] Plastic Half-Bracket	47612-SBK
[ D ] Single Plastic Bracket	47612-DBK
[ E ] Data Plastic Bracket	47612-DBK
[ F ] Universal Shelf Bracket	47612-UBK
[ G ] 6" Universal Bracket (Set of 2)	47612-6SB
[ H ] 12" Universal Bracket (Set of 2)	47612-15B
[ I ] Half Width Universal Security Plate	47612-HSB
[ J ] Full Width Universal Security Plate	47612-FSB

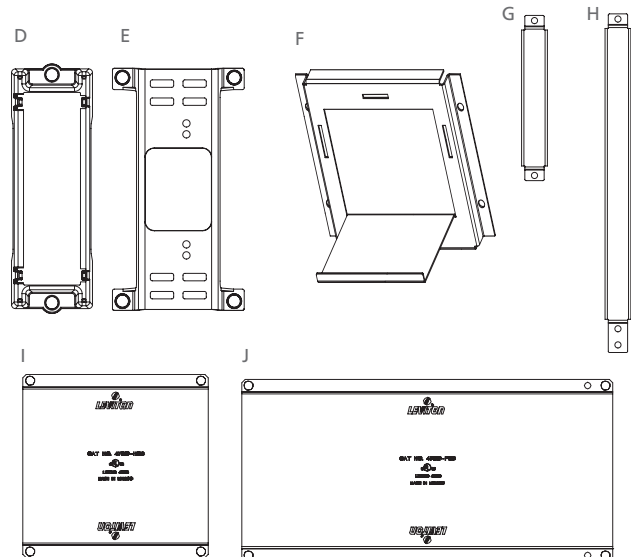

**STAND ALONE MODULES & EXPANSION BOARDS**

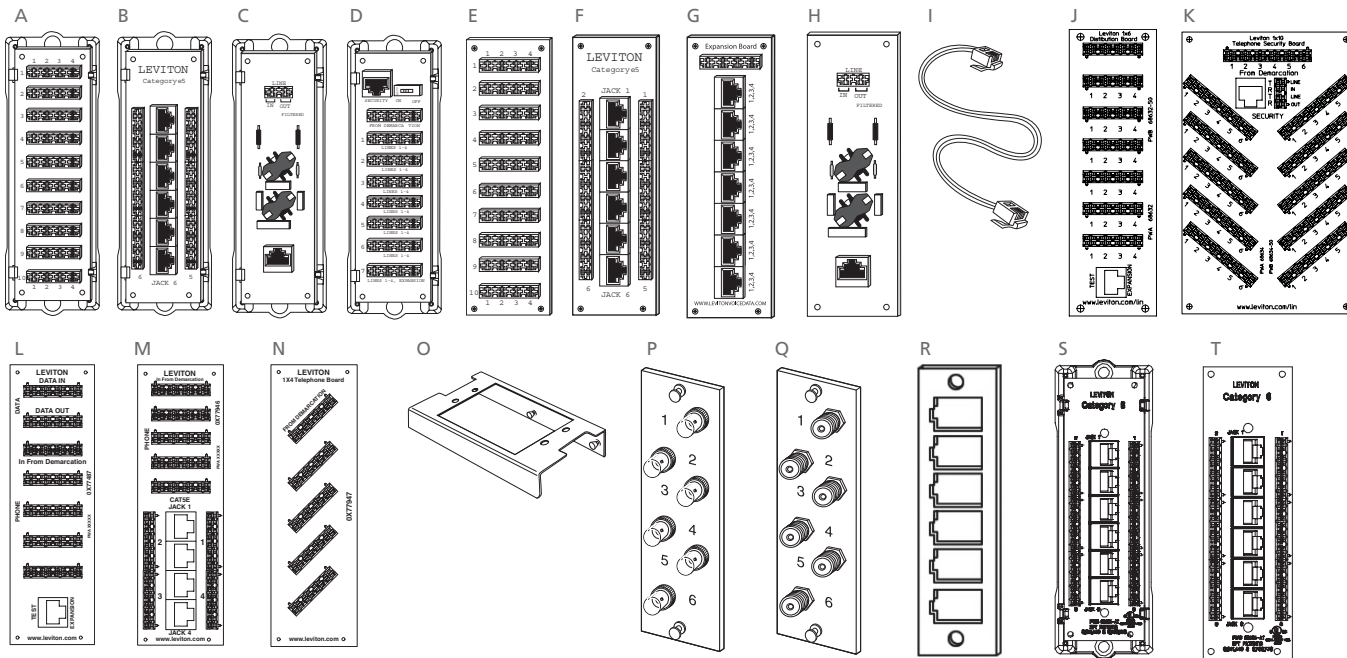

[A] 1x9 4-Line Bridged Telephone Module (stand alone)	47689-00B	[L] 1x5 4-Line Bridged Phone with Data Pass Through (expansion board)	47609-D5P
[B] Category 5e Voice and Data Module (stand alone)	47605-C5B	[M] 1x4 Port 4-Line Bridged Phone and 4 Port Cat 5e Board (expansion board)	47609-4DP
[C] DSL Filter Module (stand-alone)	47616-DSB	[N] 1x4 Bridged Phone Board (expansion board)	47609-004
[D] Telephone Security Module (stand alone)	47609-TSV	[O] Multimedia Bracket	47612-MMA
[E] 1x9 4-Line Bridged Telephone Board (expansion board)	47603-110	[P] BNC Mounting Plate, 6-pack, loaded	5F100-BNC
[F] Category 5e Voice and Data Board (expansion board)	47603-C5	[Q] F-Connector Mounting Plate, 6-pack, loaded	5F100-6VF
[G] Telephone Patching Board (expansion board)	47609-EMP	[R] QuickPort® Mounting Plate, 6-pack, unloaded	5F100-6QP
[H] DSL Filter (expansion board)	47616-DSF	[S] Category 6 Voice and Data Module (stand-alone)	47611-C6B
[I] 8-Conductor Flat Telephone Patch Cord, 8" long	42400-8FG	[T] Category 6 Voice and Data Board (expansion board)	47611-C6
[I] 4-Conductor Flat Telephone Patch Cord, 7" long	42400-G	4x18 Telephone Distribution Board (not shown)	47603-18B
[J] 1x6 4-Line Bridged Telephone Board (expansion board)	47609-F6	4x12 Telephone Distribution Board (not shown)	47603-12B
[K] 1x10 6-Line Bridged Telephone Security Board (expansion board)	47609-S10		

**POWER MODULES**

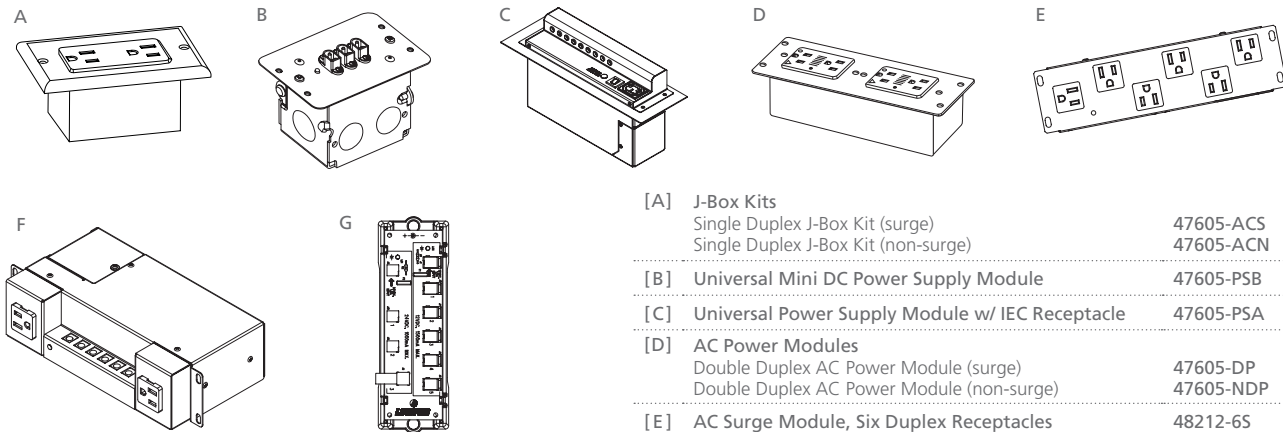

[A] J-Box Kits Single Duplex J-Box Kit (surge)	47605-ACS
Single Duplex J-Box Kit (non-surge)	47605-ACN
[B] Universal Mini DC Power Supply Module	47605-PSB
[C] Universal Power Supply Module w/ IEC Receptacle	47605-PSA
[D] AC Power Modules Double Duplex AC Power Module (surge)	47605-DP
Double Duplex AC Power Module (non-surge)	47605-NDP
[E] AC Surge Module, Six Duplex Receptacles	48212-6S
[F] Versatile Power Supply 12VDC and NEMA AC	47605-PSC
IEC to NEMA Adapter Cord	48212-IEC
[G] DC Bus 12 and 24 VDC Power Supply	48212-12A

**DATA NETWORKING ROUTERS AND SWITCHES**

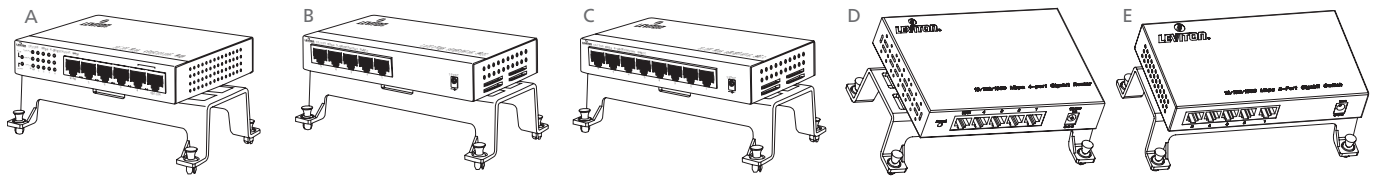

[A] 10/100 Internet Router w/ Switch	47611-GT4	[D] 10/100/1000 Gigabit Internet Router w/ Switch	47611-GB4
[B] 10/100 5-Port Switch	47611-5PT	[E] 10/100/1000 Gigabit 5-Port Switch	47611-5GB
[C] 10/100 8-Port Switch	47611-8PT		

**HOME MONITORING**

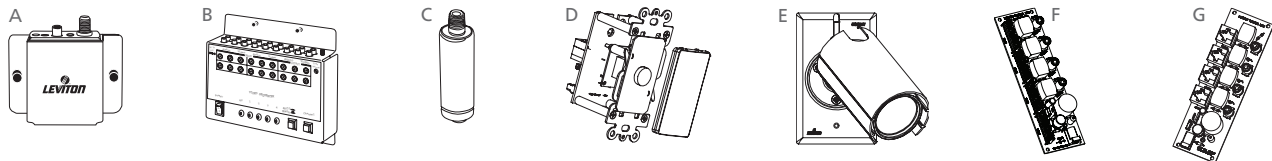

[A] Structured Media® Center Modulator	48213-VMA	[E] Outdoor Camera	VSOUT-00W
[B] Video Sequencer	48213-CVS	[F] Camera Hub With IDC Connectors	VSHUB-IDC
[C] RF Notch Filter	47690-NFA	[G] Camera Hub	VSHUB-000
[D] Indoor Camera	VSIND-05C		

**INTERCOM**

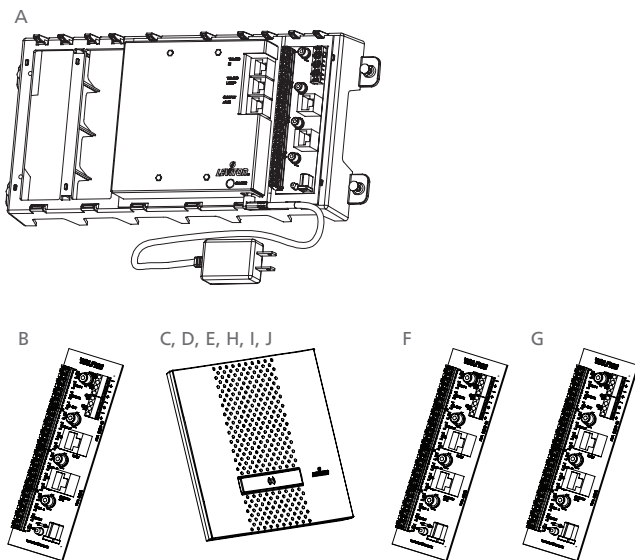

[A] Main Controller Board Kit <i>Main Controller Board and one Interface Board on a bracket with one Outdoor Station with warm silver face plate.</i>	47000-MKB
Main Controller Board Only (not shown)	47000-M
[B] Interface Board (four additional ports)	4700-PRT
[C] Outdoor Station – Warm Silver	47000-0D1
[D] Indoor Station – White	47000-0W1
[E] Indoor Station – Black	47000-0E1
[F] Door Chime	47000-CHM
[G] Door Strike	47000-STR
[H] Warm Silver Color Change Kit	47000-CWS
[I] Soft Gold Color Change Kit	47000-CSG
[J] Sterling Blush Color Change Kit	47000-CSB

**VIDEO MODULES**

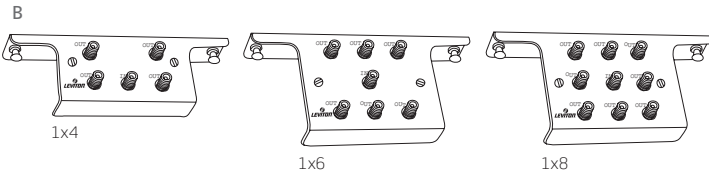
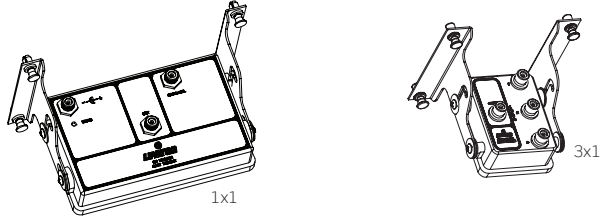
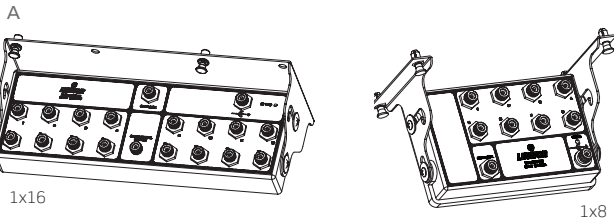

[A] Premium Amplified CATV Modules, SCTE/HDTV/DOCSIS Transmission Compliant

1x1 Premium Amplified CATV Module, SCTE/HDTV/DOCSIS Transmission Compliant	47693-01P
1x8 Premium Amplified CATV Module, SCTE/HDTV/DOCSIS Transmission Compliant	47693-08P
1x16 Premium Amplified CATV Module, SCTE/HDTV/DOCSIS Transmission Compliant	47693-16P
3x1 Premium Passive CATV Module, SCTE/HDTV/DOCSIS	47693-31P

[B] Passive TV/CATV Splitter Modules

1x4 Passive TV/CATV Splitter Module (2.05 GHz)	47690-4C2
1x6 Passive TV/CATV Splitter Module (2.05 GHz)	47690-6C2
1x8 Passive TV/CATV Splitter Module (2.05 GHz)	47690-8C2
1x4 Passive TV/CATV Splitter Module (1 GHz)	47690-04C
1x6 Passive TV/CATV Splitter Module (1 GHz)	47690-06C
1x8 Passive TV/CATV Splitter Module (1 GHz)	47690-08C

Passive TV/CATV Splitter Without Bracket (not shown)

1x4, Passive TV/CATV Splitter, No Bracket (2.05 GHz)	47690-0G4
1x6, Passive TV/CATV Splitter, No Bracket (2.05 GHz)	47690-0G6
1x8, Passive TV/CATV Splitter, No Bracket (2.05 GHz)	47690-0G8
1x4, Passive TV/CATV Splitter, No Bracket (1 GHz)	47690-004
1x6, Passive TV/CATV Splitter, No Bracket (1 GHz)	47690-006
1x8, Passive TV/CATV Splitter, No Bracket (1 GHz)	47690-008

**WHOLE HOUSE AND SMC SURGE PROTECTION**

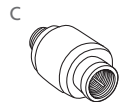
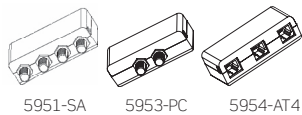
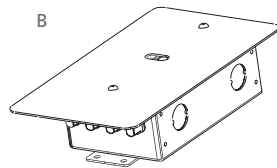
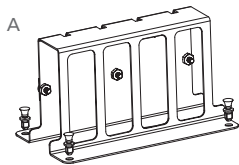

[A] Surge Module Bracket	03950-BKT
Satellite/CATV Protection Module, 4 F-Connectors	05951-OSA
CATV Protection Module, 2 F-Connectors	05953-0PC
Telephone/Fax/Modem Protection Module, 3 RJ-11 Connectors	05954-AT4
[B] Whole House Surge Protection Module, 2 RJ-11, 2 RF Connectors	51110-PTC
Whole House Surge Protection Module	51110-001
Whole House Surge Protection Module, 4 RJ-11, 4 RF Connectors	51110-CT8
[C] Coaxial Surge Suppressor	47690-06S

**ANTENNA MODULE & SATELLITE MULTI-SWITCH**

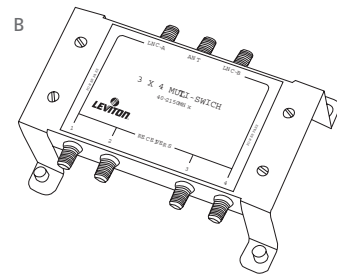
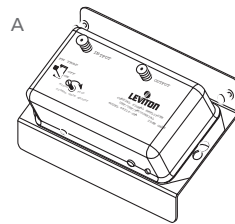

[A] Digital and HDTV Antenna Amplifier Module	48210-0VA
[B] 3x4 Multi-Switch	47691-3MS



**TOOLS**

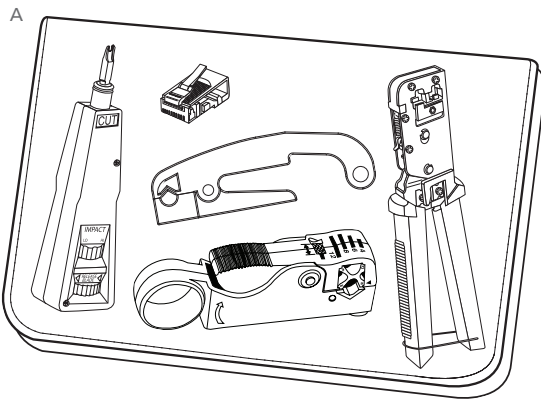

**Residential Tool Kit**

*Includes: Punchdown Tool with 110 blade, EZ-RJ45®*

[A] *Crimp Tool, 2 Level Coaxial Cable Strippers, UTP Stripping Tool, Coax and Round Wire Cable Cutter, EZ-RJ45 Connectors, Screwdriver.* 40812-RTK

[B] **Wire Punchdown/Termination Tool** (Blades sold separately) 49553-814

[C] **Wire Punchdown/Termination Tool Blades** 47603-110

110 IDC Blade 49553-110

66-Clip Blade 49553-066

BIX® Blade 49553-BIX

Krone® Blade 49553-KRN

Awl (Woodscrew starter punch) 49553-AWL

[D] **Master Compression Tool** (See Page 5 for Compression Connectors) 40989-CPT

[E] **UTP Stripping Tool** 49660-00P

[F] **Coaxial Stripping Tool** C5914-000

[G] **EZ-RJ45 Crimp Tool** 40989-RCT

[H] **Palm Termination Tool** 47615-PTT

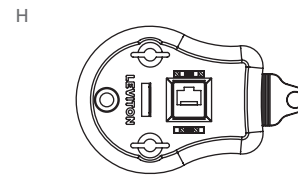
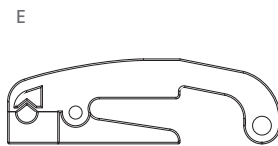
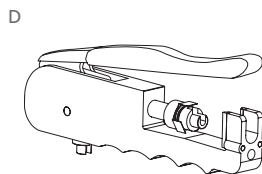
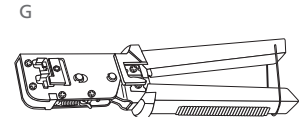
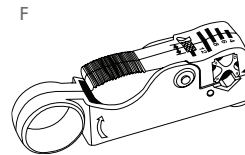
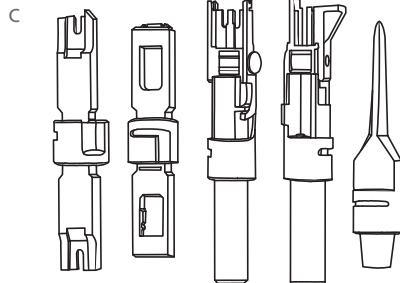
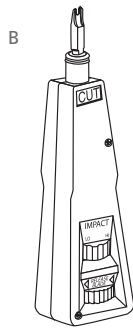

**ACCESSORIES**

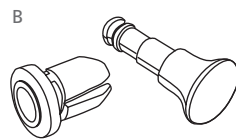
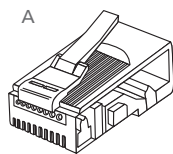

[A] **EZ-RJ45 Connector**  
EZ-RJ45 Connector (50 per pack) 47613-EZC  
EZ-RJ45 Connector Display Pack (10 per pack) 47613-EZR

[B] **Push-Lock Pins for Structured Media® Centers** (20 per pack) 47615-NYL

[C] **4x4 Telephone Line Breakout Module** 47609-4X4

[D] **VELCRO® Brand Tie-Wrap, 5" Length** (25 per pack) 43105-005

[E] **VELCRO® Brand Tie-Wra, 8" Length** (25 per pack) 43108-008

[F] **VELCRO® Brand Tie-Wra, 12" Length** (25 per pack) 43112-012

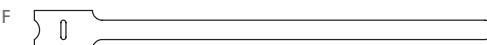
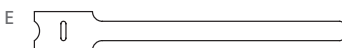
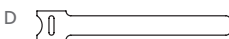
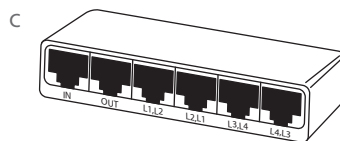

**PERFORMANCE PATCH CORDS**

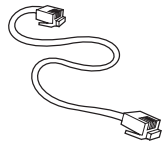

HOME 5e™ Patch Cable .....5LHOM-xx\*  
 Ultra High Flex HOME 5e Patch Cable ...5HHOM-xx\*  
 xx = Length: 01, 02, 03, or 04 feet, 6l = 6 inches  
 \* = Color: Red (R), Yellow (Y), White (W), Blue (L)

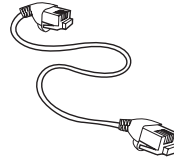

HOME 6™ Patch Cable .....6LHOM-xx\*  
 Ultra High Flex HOME 6 Patch Cable .....6HHOM-xx\*  
 xx = Length: 01, 02, 03, or 04 feet, 6l = 6 inches  
 \* = Color: Red (R), Yellow (Y), White (W), Blue (L)

**QUICKPLATES® (WITH INTEGRAL DATA, PHONE AND F-CONNECTORS, AND REAR FACING PUNCHDOWN FOR DATA AND PHONE JACKS)**

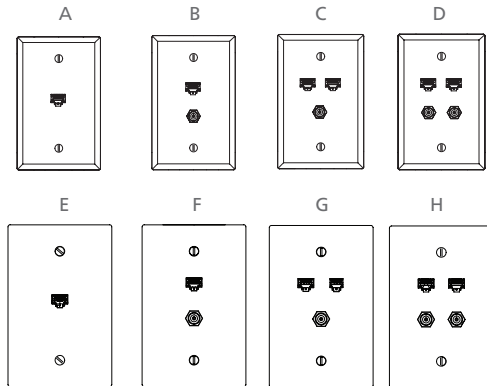

Standard 1 Data	5EA20-S1*
Standard 1 Data, 1 F-Connector	5EA20-S2*
Standard 1 Data, 1 Phone, 1 F-Connector	5EA20-S3*
Standard 2 Data, 2 F-Connectors	5EA20-S4*
Midsize 1 Data	5EA20-M1*
Midsize 1 Data, 1 F-Connector	5EA20-M2*
Midsize 1 Data, 1 Phone, 1 F-Connector	5EA20-M3*
Midsize 2 Data, 2 F-Connectors	5EA20-M4*

\* = Color: Ivory (I), White (W), Almond(A), Light Almond (T)

**QUICKPORT® WALLPLATES, SINGLE-GANG - ACCEPTS ANY QUICKPORT SNAP-IN ADAPTER**

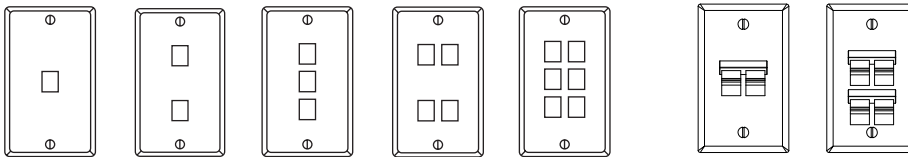

**QuickPort Single-Gang Wallplates**

1-Port	41080-1*P
2-Port	41080-2*P
3-Port	41080-3*P
4-Port	41080-4*P
6-Port	41080-6*P

\* = Color: Ivory (I), White (W), Almond(A), Light Almond (T), Grey (G), Black (E), Brown (B)

**QuickPort Angled Single-Gang Wallplates**

1-Port	41081-2*P
2-Port	41081-4*P

\* = Color: Ivory (I), White (W), Light Almond (T)

**QUICKPORT STAINLESS STEEL WALLPLATES, SINGLE-GANG - ACCEPTS ANY QUICKPORT SNAP-IN ADAPTER**

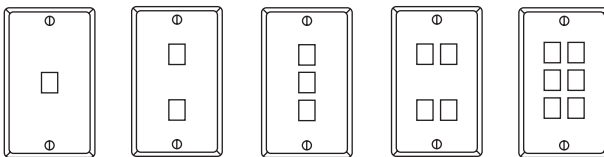

1-Port	43080-1S1
2-Port	43080-1S2
3-Port	43080-1S3
4-Port	43080-1S4
6-Port	43080-1S6

**DECORA® & ELECTRICAL-STYLE MULTIMEDIA INSERTS - FIELD CONFIGURABLE WITH ANY QUICKPORT ADAPTER**

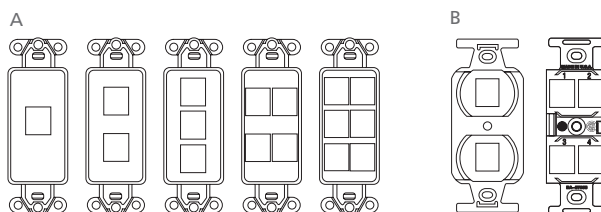

**[A] Decora Plus Multimedia inserts** 41641-\*

† = Port configuration: (1), (2), (3), (4), (6)  
 \* = Color: Ivory (I), White (W), Grey (GY), Black (E), Almond (A), Light Almond (T), Brown (B)

**[B] Electrical-Style Multimedia Inserts**

Duplex 106®	41087-2*P
Quad 106®	41087-Q*P

\* = Color: Ivory (I), White (W), Grey (G), Black (E), Light Almond (T)

**DECORA® & ELECTRICAL-STYLE WALLPLATES**

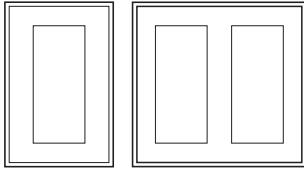

**Decora Plus Snap-on Wallplates**

Single-Gang	80301-S*
Dual-Gang	80309-S*

\* = Color: Ivory (I), White (W), Grey (GY), Black (E), Almond (A), Light Almond (T), Brown (no letter used)

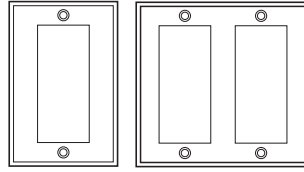

**Decora Wallplates**

Single-Gang	80401-*
Single-Gang (nylon)	80401-N*
Dual-Gang	80409-*
Dual-Gang (nylon)	80409-N*

\* = Color: Ivory (I), White (W), Grey (GY), Black (E), Almond (A), Light Almond (T), Brown (no letter used)

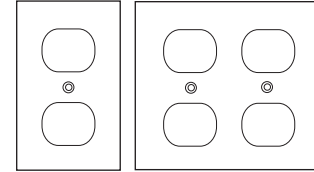

**Nylon Electrical Wallplates**

Single-Gang	80703-*
Dual-Gang (nylon)	80716-*

\* = Color: Ivory (I), White (W), Grey (GY), Black (E), Almond (A), Light Almond (T), Brown (no letter used)

**SNAP-IN ADAPTERS AND CONNECTORS**

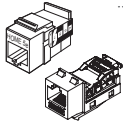

**HOME 5e™ QuickPort® Connectors**

Standard	5EHOM-R*5
Tool-Free	5ETLS-R*5

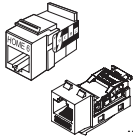

**HOME 6™ QuickPort Connectors**

Standard	61HOM-R*6
Tool-Free	61TLS-R*6

\* = Color: Ivory (I), Brown (B), White (W), Grey (G), Black (E), Blue (L), Light Almond (T)



**BNC**

Standard BNC	41084-B*F
Gold Plated BNC	40832-0B°



**S-Video**

S-Video Feedthrough	40734-CV~
S-Video to 110	40734-SV*



**3.5MM Stereo**

3.5MM Stereo screw terminal	40839-S~S
-----------------------------	-----------



**F-Type Modules**

Standard F-Type, 1GHz	41084-F*F
Gold Plated F-Type, 2.5GHz	40831-0B°



**Binding Post Adapters**

Gold plated w/ black stripe	40833-B*E
Gold plated w/ red stripe	40833-B*R

\* = Color: Ivory (I), White (W), Almond (A), Light Almond (T), Grey (G), Black (E), Brown (B)  
 † = Color: Ivory (I), White (W), Almond (A), Light Almond (T), Grey (G), Black (E)



**CAT 5 Connectors**

41108-R†5



**CAT 3 Connectors**

41108-R†3

**Voice Grade Connectors**

6-conductor USOC connector	41106-R†6
8-conductor USOC connector	41108-R†8

† = Color: Ivory (I), White (W), Grey (G), Black (E), Orange (O), Blue (L), Crimson Red (C), Dark Red (R), Yellow (Y), Brown (B), Almond (A), Lt Almond (T), Green (V), and Purple (P)



**RCA to 110**

40735-Rx†

x = Inner Barrel Color: Orange(O), Red(R), White(W), Yellow(Y) Ivory and White connectors available with Green(V) or Blue(L) Inner Barrel



**RCA w/ black stripe**

40830-B\*E

**RCA w/ red stripe**

40830-B\*R

**RCA w/ yellow stripe**

40830-B\*Y

**RCA w/ green stripe**

40830-B~V

**RCA w/ blue stripe**

40830-B~L



**Snap-in Blank Module**

41084-B\*B



**Banana Jack Adapters**

Gold Plated w/ black stripe

40837-B\*E

Gold Plated w/ red stripe

40837-B\*R

° = Color: Ivory (I), White (W), Almond (A), Light Almond (T)  
 ~ = Color: Ivory (I), White (W)

**COMPRESSION CONNECTORS**

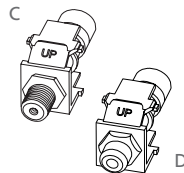
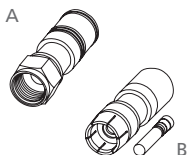

**Compression Connectors**

[A] F-Style	40985-CPF
[B] RCA-Style	40985-CRU
[C] QuickPort F-Style	40982-CPF
[D] QuickPort RCA-Style	40982-R*W

\* = Color: Red (R), Black (E), Yellow (Y), Blue (B), Green (V)  
 Call for availability on QuickPort Compression Connectors

**CHEETAH SPEED SYSTEM**

The patented Cheetah Speed System® enables wall plates to be installed without screws using a revolutionary speed anchor and snap & lock system. The Cheetah Speed System increases the speed of installation by up to 50%, and at the same time offers the elegance, style and designer appearance of self-aligning screwless wallplates.

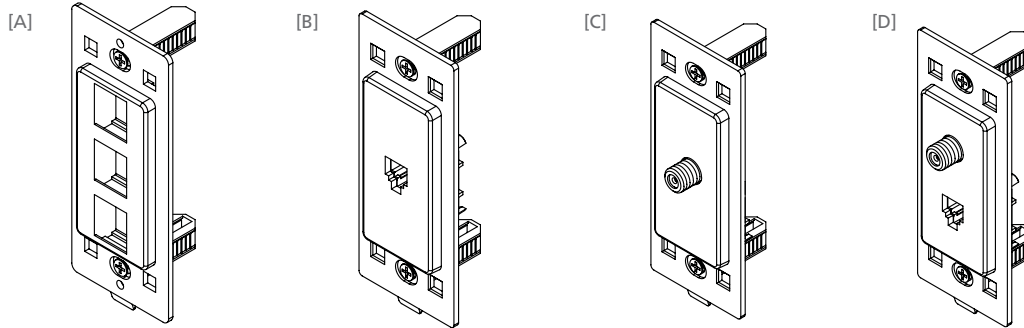

**Inserts**

[A]	Cheetah Decora® 3-Port Insert	5020-C**
[B]	Cheetah Decora Telephone Insert	CH149-00x

**Inserts**

[C]	Cheetah Decora Coax Insert	CH181-00x
[D]	Cheetah Decora Telephone/Coax Insert	CH159-00x

\*\* = Color: White (0W), Light Almond (AL), Ivory (0I), Black (0B)  
 x = Color: White (W), Light Almond (T), Ivory (I), Black (E)

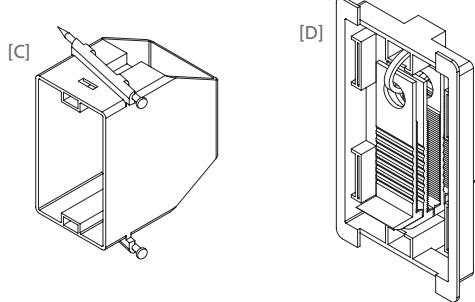

**Boxes and Brackets**

[C]	Cheetah Single-Gang Non-Metallic Datacom Box (Includes two nails and two self-tapping screws)	3005C-C00
[D]	Cheetah Low Voltage Datacom Cut-in Bracket	4007C-C00

LEVITON.COM | 800.722.2082

**LEVITON NETWORK SOLUTIONS DIVISION HEADQUARTERS**

2222 - 222nd St. S.E., Bothell, WA 98021-4422 USA

T 800.722.2082

F 425.487.9486

E insidesales@leviton.com

**LEVITON CORPORATE HEADQUARTERS**

201 N Service Road, Melville, NY 11747 USA

T 800.323.8920

F 800.832.9538

E info@leviton.com

