



Combination Devices

INDEX

Commercial Grade

| | |
|-------------------|----|
| Decora® | 30 |
| Traditional | 34 |

Residential Grade

| | |
|---------------------------------------|----|
| Decora® LED Sensor Guide Lights | 37 |
|---------------------------------------|----|

Combination Devices

With Leviton's extensive assortment of combination devices, you can fill a one-gang space with two switches, a switch and receptacle, a switch and pilot light, three rocker switches — even a single pole switch and a SmartlockPro® GFCI outlet.



Decora®

Part of Leviton's celebrated designer collection, Decora Combination Devices offer switch/switch, switch/receptacle and switch/pilot light pairings in sleek packages suitable for the finest interiors. For the ultimate in convenience and safety, the Decora Combination Switch/SmartlockPro GFCI Receptacles pair a single pole switch with a GFCI receptacle equipped with Leviton's pioneering true dead-face design.

COLORS

Decora devices are offered in a wide range of colors and finishes. To order colors, add suffix to Cat No.



White
(-W)



Ivory
(-I)



Almond
(-A)



Light Almond
(-T)



Grey
(-G)



Black
(-E)



Brown
(-D)

Specifications and Features

- Elegant Decora® styling provides multiple control in a single-gang wallbox
- Impact-resistant thermoplastic and double-wipe contacts
- Common shunted internally to all switches
- Limited Two-Year Warranty

Tamper Resistant Receptacles

- Shutter mechanism inside the receptacle blocks access to the contacts unless a two-prong plug is inserted, helping ensure hairpins, keys, etc., will be locked out
- TR symbol on residential receptacles assures they meet the 2008 NEC requirement
- Heavy-duty construction offers long, trouble-free service life

All SmartlockPro® Combination Devices

- TEST/RESET buttons match device color
- Dual function LED indicator light - provides indication of wiring error and power availability



SmartlockPro GFCI/Sensor Guide Light

- Manual control of sensor light using the TEST/RESET buttons
- Long-lasting, energy efficient LEDs with 20-year life expectancy — no bulbs to replace
- Light sensor provides automatic ON/OFF features

SmartlockPro GFCI/Switch

- Replaces standard switch/outlet combination devices in residential or light commercial installations
- Permits multiple wiring options that allow for GFCI protection of switched load and downstream receptacles

DECORA COMBINATION DEVICES*  

| Description | Color | Cat No. | Cat. No. |
|---|--------------|---|--|
| NEMA | |  |  |
| | | 5-15R | 5-20R |
| Rating | | Switch: 15A-120VAC Receptacle: 15A-125V | |
| Single Pole Switch/ Tamper-Resistant Receptacle | White | T5625-W | |
| | Ivory | T5625-I | |
| | Almond | T5625-A | |
| | Light Almond | T5625-T | |
| | Grey | T5625-GY | |
| | Brown | T5625-E | |
| Single Pole Switch/Receptacle | White | 5625-W | 5636-W |
| | Ivory | 5625-I | 5636-I |
| | Almond | 5625-A | 5636-A |
| | Light Almond | 5625-T | — |
| | Grey | 5625-GY | — |
| | Black | 5625-E | — |
| Rating | | Switch: 15A-120VAC Pilot Light: 1/25W-125VAC | Switch: 20A-120VAC Pilot Light: 1/25W-125VAC |
| Single Pole Switch/Pilot Light | White | 5626-W | 5637-W |
| | Ivory | 5626-I | 5637-I |
| | Almond | 5626-A | 5637-A |

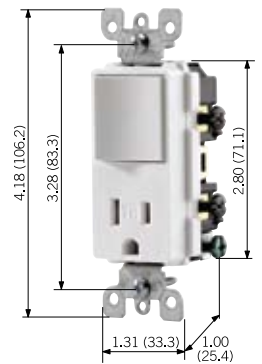

T5625-W

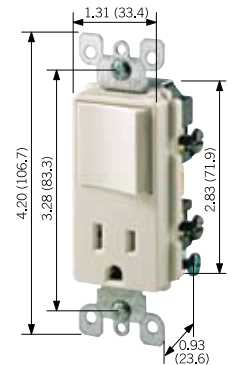

5625-W

Continued On Next Page >

Commercial Grade

Continued From Previous Page >

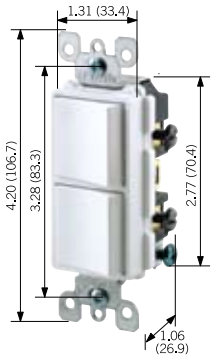

5634-W

| Description | Color | Cat No. | Cat. No. |
|-------------------------------------|--------------|-----------------------------|-----------------------|
| NEMA | | 5-15R | 5-20R |
| Rating | | 15A-120/277VAC | 20A-120/277VAC |
| Two Single Pole Switches | White | 5634-W | 5627-W |
| | Ivory | 5634-I | 5627-I |
| | Almond | 5634-A | 5627-A |
| | Light Almond | 5634-T | 5627-T |
| | Grey | 5634-GY | — |
| | Black | 5634-E | — |
| | Brown | 5634 | — |
| Rating | | 15A-120/277VAC | |
| 3-Way Switch/ Single Pole Switch | White | 5641-W | |
| | Ivory | 5641-I | |
| | Almond | 5641-A | |
| | Light Almond | 5641-T | |
| | Black | 5641-E | |
| Two 3-Way Switches | White | 5643-W | 5640-W |
| | Ivory | 5643-I | 5640-I |
| | Almond | 5643-A | 5640-A |
| | Light Almond | 5643-T | 5640-T |
| Rating | | Switch: 15A-120VAC | |
| | | Receptacle: 15A-125V | |
| 3-Way Switch/ Receptacle | White | 5645-W | |
| | Ivory | 5645-I | |
| | Almond | 5645-A | |
| | Light Almond | 5645-T | |
| | Black | 5645-E | |

*All with ground screw

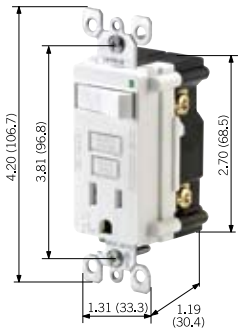

7299-W

| Description | Color | Cat No. |
|--|--------------|--|
| Rating | | Receptacle 15A-125V Feed-through: 20A-125V Switch Rating: 15A, 1800W @ 120VAC |
| Single Pole Switch and Tamper Resistant SmartlockPro® GFCI-Protected Receptacle with Indicator Light | White | T7299-W |
| | Ivory | T7299-I |
| | Almond | T7299-A |
| | Light Almond | T7299-T |
| Single Pole Switch and SmartlockPro GFCI-Protected Receptacle with Indicator Light | White | 7299-W |
| | Ivory | 7299-I |
| | Almond | 7299-A |
| | Light Almond | 7299-T |

| Description | Color | Cat No. |
|-------------------------------------|--------------|---|
| Rating | | Receptacle 15A-125V Feed-through: 20A-125V |
| Automatic ON/OFF Sensor | White | T7591-W |
| LED Guidelight and Tamper Resistant | Ivory | T7591-I |
| SmartlockPro® GFCI-Protected | Almond | T7591-A |
| Receptacle with Indicator Light | Light Almond | T7591-T |
| Rating | | Receptacle 15A-125V Feed-through: 20A-125V |
| Automatic ON/OFF Sensor | White | 7591-W |
| LED Guidelight and SmartlockPro | Ivory | 7591-I |
| GFCI-Protected Receptacle | Almond | 7591-A |
| with Indicator Light | Light Almond | 7591-T |

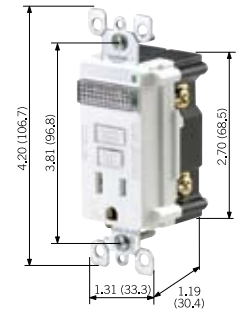

7591-W

DECORA® COMBINATION SWITCHES†

| Description | Color | Cat No. non-grounded | Cat. No. with ground screw |
|--------------------------------------|--------------|---|---|
| Rating | | Individual Switches: 15A-120V Device Total: 20A-120V | Individual Switches: 15A-120V Device Total: 20A-120V |
| Dual Rockers | White | 1754-W | 1754-2W |
| | Ivory | 1754-I | — |
| | Almond | 1754-A | — |
| | Light Almond | 1754-T | — |
| Illuminated | White | 1754-ILW | — |
| Dual Rockers | Ivory | 1754-ILI | — |
| (Light is ON when top rocker is OFF) | Almond | 1754-ILA | — |
| Three Rockers | White | 1755-W | 1755-2W |
| | Ivory | 1755-I | 1755-2I |
| | Almond | 1755-A | — |
| | Light Almond | 1755-T | — |

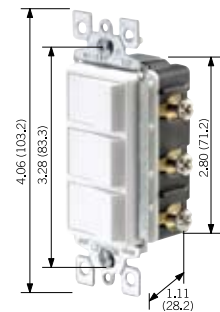

1755-W

†Warning: Although each individual rocker switch is rated up to 15A-120V, the total combined load for both duplex or all three triplex switches must not exceed 20 AMPS.

TESTING AND CODE COMPLIANCE

Decora Combination Switches

- UL Listed (File #E-7458)
- CSA Certified (File #LR-3413)
- NOM Certified (#057)

Switch/SmartlockPro GFCI Receptacle

- Meets or exceeds all new UL requirements for July 28, 2006
- UL Standard 943 Class A (GFCI) and 498 (Receptacles), 20 (Switches)
- UL Listed (File # E-48380)
- CSA Certified (File #LR-57811)
- NOM Certified (File #057)

MATERIAL CHARACTERISTICS

Decora Combination Switches

Environmental: Flammability UL-94, V2 Rating
Operating Temperature: -40°C to 120°C

Switch/SmartlockPro GFCI Receptacle

Environmental: Flammability UL-94 V2 Rating
Operating Temperature: -35°C to 65°C

Commercial Grade

Traditional

Leviton's Combination Devices offer pleasing, practical designs that fit standard wallboxes. Switch/switch, switch/receptacle and switch/pilot light combinations are available. These devices come in a range of colors and are backed by a limited two-year warranty.

Specifications and Features

- AC quiet switches have silver-cadmium oxide contacts and receptacles have double-wire contacts for maximum conductivity
- All devices have a grounding screw, except where noted
- Terminal screws accept up to No. 12 AWG copper or copper-clad wire
- Fits standard wallboxes
- Break-off tabs on devices with switches permit conversion to separate feeds
- Limited Two-Year Warranty

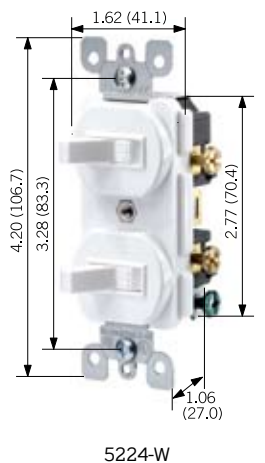
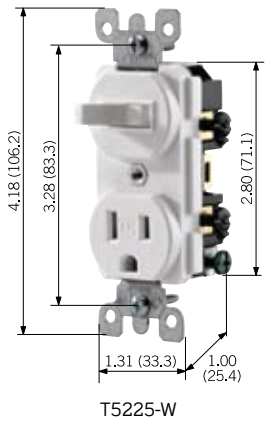

Tamper Resistant Receptacles

- Shutter mechanism inside the receptacle blocks access to the contacts unless a two-prong plug is inserted, helping ensure hairpins, keys, etc., will be locked out
- TR symbol on residential receptacles assures they meet the 2008 NEC requirement
- Heavy-duty construction offers long, trouble-free service life



COMBINATION DEVICES

| Description | Color | Cat No. | Cat. No. |
|---|--|--|--|
| NEMA | | 5-15R | 5-20R |
| Rating | | Switch: 15A-120VAC Receptacle: 15A-125V | |
| Single Pole Switch/ Tamper Resistant Receptacle* | White Ivory Almond Light Almond Brown | T5225-W T5225-I T5225-A T5225-T T5225 | |
| Rating | | Switch: 15A-120VAC Receptacle: 15A-125V | Switch: 20A-120VAC Receptacle: 20A-125V |
| Single Pole Switch/Receptacle* | White Ivory Almond Light Almond Black Brown | 5225-W 5225-I 5225-A 5225-T — 5225 | 5335-W 5335-I — — 5335-E 5335 |
| Rating | | 15A-120/277VAC | |
| Two Single Pole Switches, non-ground | White Ivory Brown | 5224-W 5224-I 5224 | |
| Rating | | 15A-120/277VAC | 20A-120/277VAC |
| Two Single Pole Switches, with ground screw | White Ivory Almond Light Almond Brown | 5224-2W 5224-2I 5224-2A 5224-2T 5224 | 5334-W 5334-I — — 5334 |

| Description | Color | Cat No. | Cat. No. |
|-----------------------------------|--------------|--|--|
| NEMA | |  5-15R |  5-20R |
| Rating | | Switch: 15A-120VAC Pilot Light: 1/25W-125VAC | Switch: 20A-120VAC Pilot Light: 1/25W-125VAC |
| Single Pole Switch/Pilot Light* | White | 5226-W | — |
| | Ivory | 5226-I | 5336-I |
| | Almond | 5226-A | — |
| | Light Almond | 5226-T | — |
| | Brown | 5226 | 5336 |
| Rating | | 15A-120/277VAC | |
| 3-Way Switch/Single Pole Switch * | White | 5241-W | |
| | Ivory | 5241-I | |
| | Almond | 5241-A | |
| | Light Almond | 5241-T | |
| | Brown | 5241 | |
| Rating | | 15A-120/277VAC | |
| Two 3-Way Switches* | White | 5243-W | |
| | Ivory | 5243-I | |
| | Almond | 5243-A | |
| | Light Almond | 5243-T | |
| | Brown | 5243 | |
| Rating | | Switch: 15A-120/277VAC Receptacle: 15A-125V | |
| 3-Way Switch/Receptacle* | White | 5245-W | |
| | Ivory | 5245-I | |
| | Brown | 5245 | |

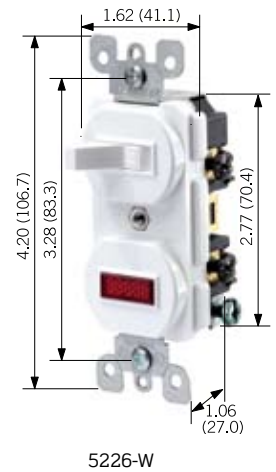

*With ground screw

TESTING AND CODE COMPLIANCE

- UL Listed (File #E-7458)
- CSA Certified (File #LR-3413)
- NOM Certified (#057)

HORSEPOWER

15A — 1/2 @ 120V, 2 @ 240V
20A — 1 @ 120V, 2 @ 240V

MATERIAL CHARACTERISTICS

Environmental: Flammability UL-94, V2 Rating
Operating Temperature: -40°C to 120°C

Commercial Grade

DIMENSIONS

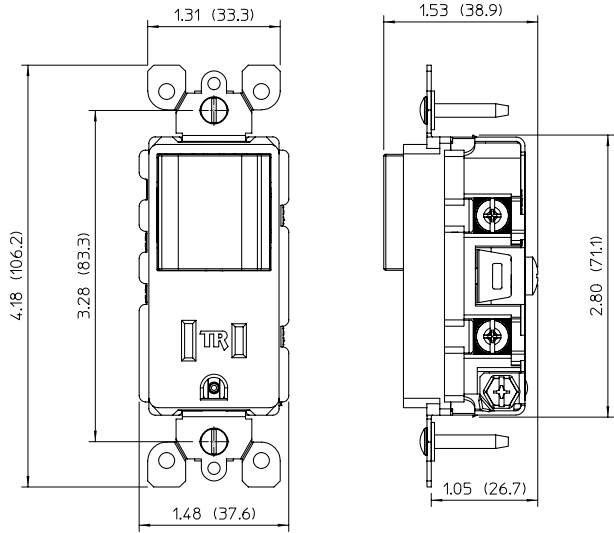

T5625 — Decora® Tamper Resistant Combination Switch/Receptacle

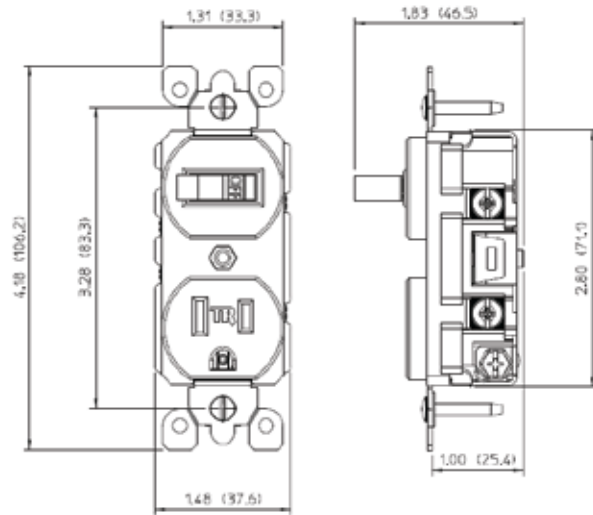

T5225 — Traditional Tamper Resistant Combination Switch/Receptacle

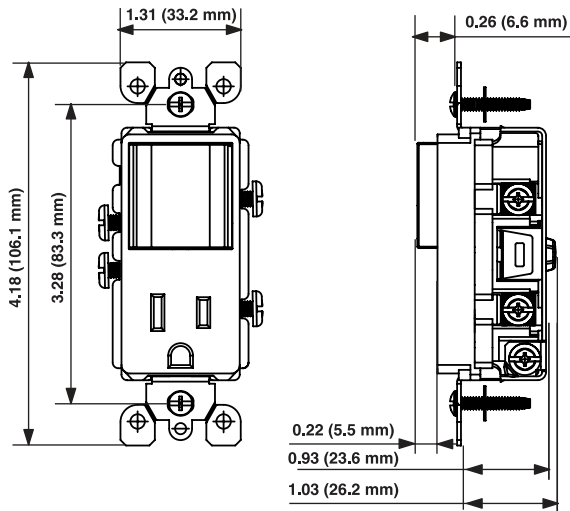

5625 — Decora® Combination Switch/Receptacle

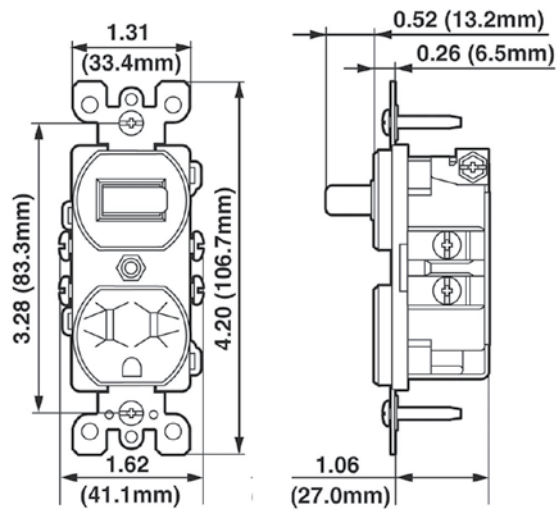

5225 — Traditional Combination Switch/Receptacle

Decora® LED Sensor Guide Lights

Our new LED Sensor Guide Light Series unites Leviton's quality Decora wiring devices with energy-saving LED Guide Lights for a smart combination. The Sensor LEDs turn ON and OFF automatically in Switch/Guide Light or Tamper-resistant Receptacle/Guide Light combinations, as well as a full LED Guide Light version that's perfect for hallways or stairways.

Specifications and Features

All Devices

- Impact-resistant face and body
- Long-lasting energy-efficient LED with long life expectancy — no bulbs to replace
- Light sensor provides automatic ON/OFF features
- All devices have a self grounding clip
- Fits standard wall boxes
- Back or side wired

Tamper Resistant Receptacle/Guide Light

- Uses two LEDs
- Shutter mechanism inside the receptacle blocks access to the contacts unless a two-prong plug is inserted, helping ensure foreign objects will be locked out
- Complies with section 406.11 of the 2008 NEC Code

Combination Switch/Guide Light

- Uses two LEDs
- Single Pole
- Neutral Required

Full LED Guide Light

- Uses three LEDs
- Color Change Kits available for select models

COLORS

Decora devices are offered in a wide range of colors and finishes. To order colors, add suffix to Cat No.



White
(-W)



Ivory
(-I)



Almond
(-A)



Light Almond
(-T)

Residential Grade

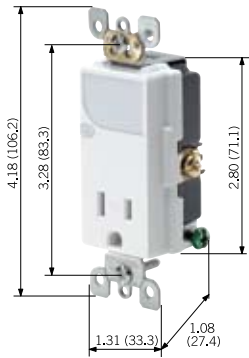

T6525

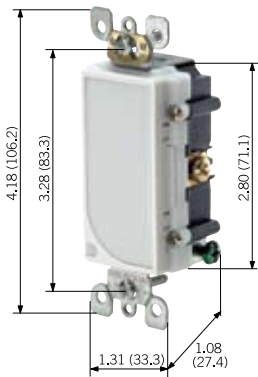

6527

DECORA® COMBINATION DEVICES*

| Description | Color | Cat No. |
|--|--------------|-------------------|
| NEMA | | 5-15R |
| Rating | | 15A-125VAC |
| Decora Tamper Resistant Receptacle/LED Guide Light | White | T6525-W |
| | Ivory | T6525-I |
| | Almond | T6525-A |
| | Light Almond | T6525-T |
| Rating | | 15A-125VAC |
| Decora Single Pole Switch/LED Guide Light | White | 6526-W |
| | Ivory | 6526-I |
| | Almond | 6526-A |
| | Light Almond | 6526-T |
| Rating | | 1W-120VAC |
| Decora Full LED Guide Light | White | 6527-W |
| | Ivory | 6527-I |
| | Almond | 6527-A |
| | Light Almond | 6527-T |

TESTING AND CODE COMPLIANCE

- UL Listed (File #E-7458)
- CSA Certified (File #LR-3413)
- NOM Certified (#057)

MATERIAL CHARACTERISTICS

Environmental: Flammability UL-94, V2 Rating
Operating Temperature: -40°C to 120°C

HORSEPOWER

- 15A — 1/2 @ 120V

DIMENSIONS

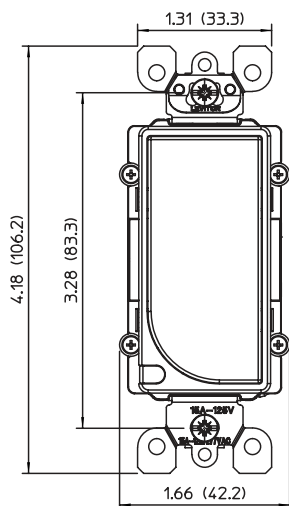

Decora 6527
Full LED Guidelight

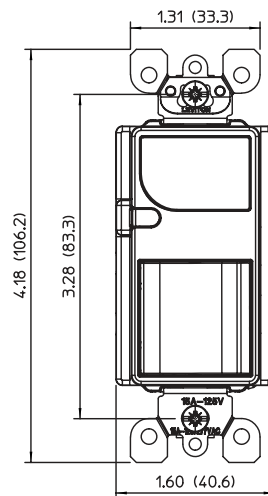
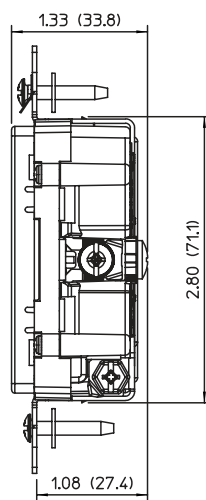

Decora 6526
Switch LED Guidelight

