



Optanium T8 Instant Start

OPTANIUM ELE BALLAST (4) F32T8 120-277V

Reliable and energy efficient Philips Advance's Centium commercial grade specifications, plus added benefits of lamp striation reduction technology.

Product data

General Information	
Lamp Type	F32T8
Number of Lamps	3/4 piece/unit
Ballast Type	Electronic Fluorescent
Base Model	IOP4P32LWN
Suitable For Outdoor Use	Yes
Automatic Restart	Yes
Operating and Electrical	
Input Voltage	120 to 277 V
Input Frequency	50 to 60 Hz
Max THD	10 %
Power (Rated) (Nom)	32 W
Starting Method	Instant Start
Lamp Current Crest Factor (Nom)	1.6
Ignition Time (Nom)	0.1 s
Ballast Factor (Nom)	0.78
Power Factor (Nom)	0.98
Input Current (Operating) (Max)	0.62 A
Input Current (Operating) (Min)	0.27 A
Input Power (Nom)	73-71 W

Rated Lamp Watts	32W W
Wiring	
Color Input Terminals	No terminals
Color Output Terminals	No terminals
Wire Striplength	0.50/0.375 mm
Lamp Connection	Parallel
Wire Length By Color	See data sheet
Wire Gauge (Nom)	18AWG mm
Wire Type	Solid
Remote Wiring Configuration Allowed	Yes
Tandem Wiring Configuration Allowed	Yes
Through Wiring Configuration Allowed	Yes
Max Ballast-Lamp Distance Remote Wiring	ES = 6' / Standard = 20'
Max Ballast-Lamp Distance Tandem Wiring	ES = 6' / Standard = 20'
Max Ballast-Lamp Distance Through Wiring	ES = 6' / Standard = 20'
Connector Type	No connector
Temperature	
T-Case Maximum (Nom)	70 °C

Optanium T8 Instant Start

Mechanical and Housing

Housing Material	Metal
Housing	N
Housing Dimensions	9.5" x 1.3" x 1.0"

Approval and Application

EMC Immunity Standard	FCC Non-Consumer
Approbation Marks	CSA certificate UL certificate CEC Listing CEE Rated NEMA Premium RoHS Compliant
Sound Rating	A
UL Recognized	No

Product Data

Order product name	OPTANIUM IOP4P32LWN35I
EAN/UPC - Product	781087125199
Order code	IOP4P32LWN35I
Numerator - Quantity Per Pack	1
Numerator - Packs per outer box	10
Material Nr. (12NC)	913701247101
Net Weight (Piece)	0.441 kg

Dimensional drawing

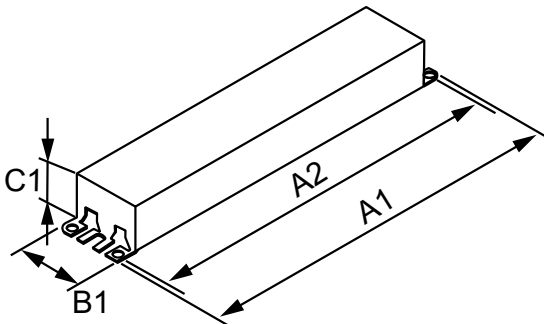

ELE BALLAST (4) F32T8 120-277V

Product	A1	A2	B1	C1
OPTANIUM IOP4P32LWN35I	9.50 in	8.90 in	1.30 in	1.00 in

