



Non-reversing motor starter
NEMA controller size 00
3-Phase, 3-Pole
Maximum voltage rating 600VAC
Max Hp 60Hz: 1 1/2@200V; 1 1/2@230V; 2@460V; 2@575V
Ambient compensated bimetal overload relay(s)
Control voltage 220–240/440–480VAC 60Hz
Open device (no enclosure)

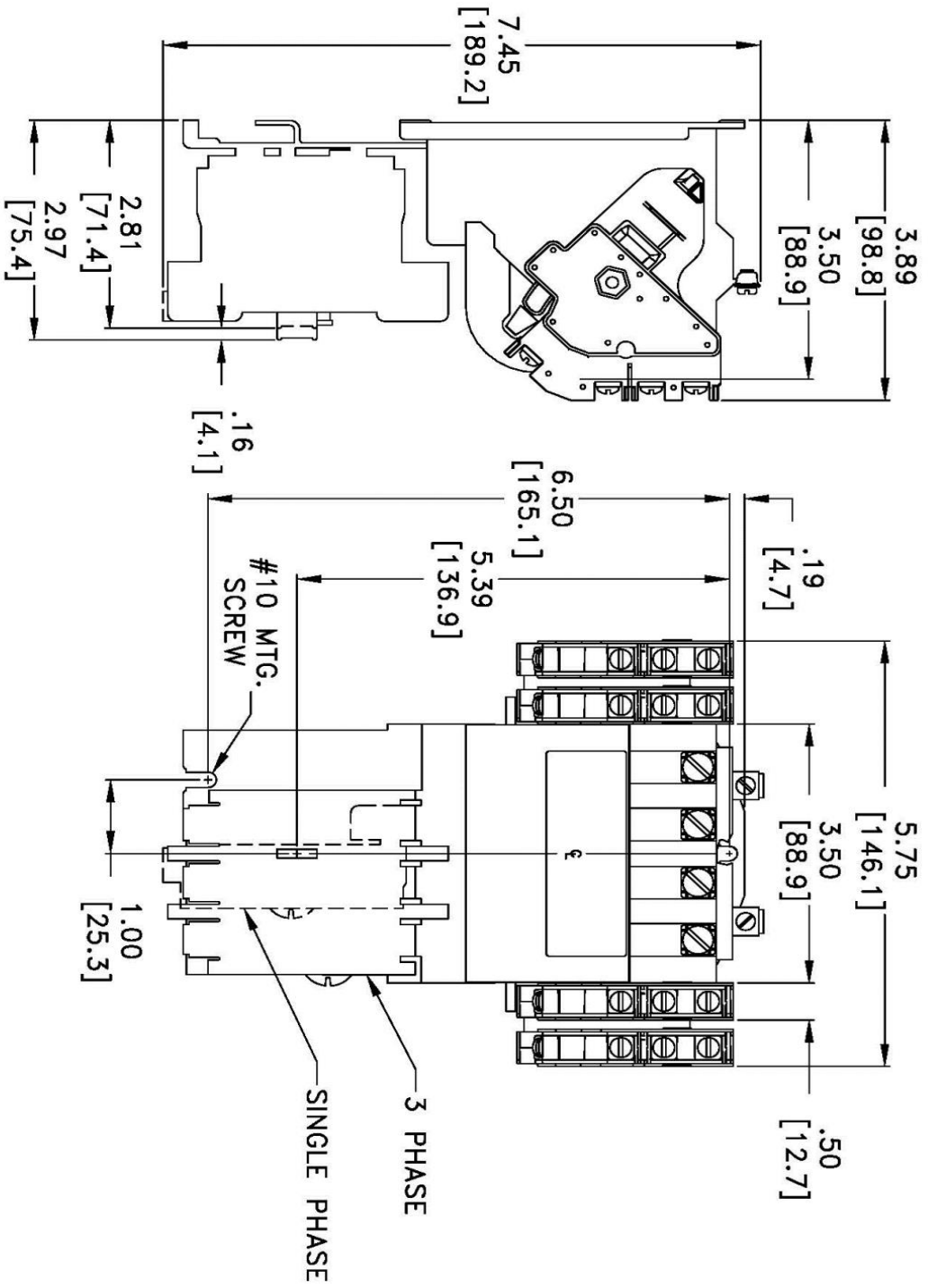

Image is representative and may not depict the actual product.

General technical data:	
Weight	3.5 lb
Height x Width x Depth	7.45 x 5.75 x 3.89 in.
Finger-safe (main circuit / control circuit)	No / No
Maximum altitude	6560 ft
Ambient storage temperature	(-30 to 65)°C / (-22 to 149)°F
Ambient operating temperature	(-20 to 40)°C / (-4 to 104)°F
Humidity (% non-condensing)	(no data)
Rated impulse voltage resistance	(no data)
Rated insulation voltage	(no data)
Country of origin	Mexico
Contactors:	
Number of NO main contacts	3
Amp rating	9A
Mechanical operating cycles	10,000,000
Internal/standard auxiliary contact:	
Number of NC / NO auxiliary contacts	0NC / 1NO
Rating	10A@600VAC (A600), 5A@600VDC (P600)
Optional auxiliary contact:	
Max number of NC / NO auxiliary contacts	8 total
Rating	10A@600VAC (A600), 5A@600VDC (P600)
Coil:	
Voltage	220–240/440–480VAC 60Hz Coil
Sealed watts	8.6W
Inrush / sealed power	218 / 25 VA
Normal coil operating limits (% of rated voltage)	85% - 110%
Typical drop-out volts (% of rated voltage)	50%
Pick-up time / Drop-out time	19-29 / 10-24 msec
Overload Relay:	
Repeat accuracy	(no data)
Trip adjustment	+/-15%
Reset options	Manual and automatic
External reset	No
Test function	Manual actuation
Number of NC / NO auxiliary contacts	1NC / 0NO
Rating of auxiliary contacts	10A@600VAC (A600), 5A@250VDC (P300)
Single contact isolation	(no data)
Dual contact isolation	(no data)
Enclosure:	
Type	Open device (no enclosure)

Rating	NA
Mounting/wiring:	
Mounting orientation	Vertical
Mounting type	Surface
Line side connection type / torque	Screw / 20 lb-in.
Line side solid & stranded conductors	1x(14 - 2 AWG) 75°C AL or CU
Load side connection type / torque	Screw / 35 lb in.
Load side solid & stranded conductors	(no data)
Coil connection type / torque	Screw / 5 lb in. - 12 lb in.
Coil solid & stranded conductors	2 x (16 - 12 AWG) CU 60/75°C
Main auxiliary contact connection type / torque	(no data)
Main auxiliary contact solid & stranded conductors	(no data)
OLR auxiliary contact connection type / torque	Screw / 5 lb in. - 12 lb in.
OLR auxiliary contact solid & stranded conductors	2 x (16 - 12 AWG) CU 60/75°C
Short circuit current rating:	
Fuses	10kA@600V (Class H or K); 100kA@600V (Class R or J)
Thermal Magnetic Circuit Breaker	14kA@240V; 10kA@600V
Certificates/approvals:	
	UL (file no. E14900)
	cUL (file no. E14900 for Canada)
	CSA (file no. LR 6535)
	ISO 9001 certification
Additional information:	
	Brochure

OUTLINE NEMA SIZE 00 - 1 3/4 CLASS 14 STARTER



DIMENSIONS ARE IN INCHES [MILLIMETERS]
 FILE NAME: D38235007

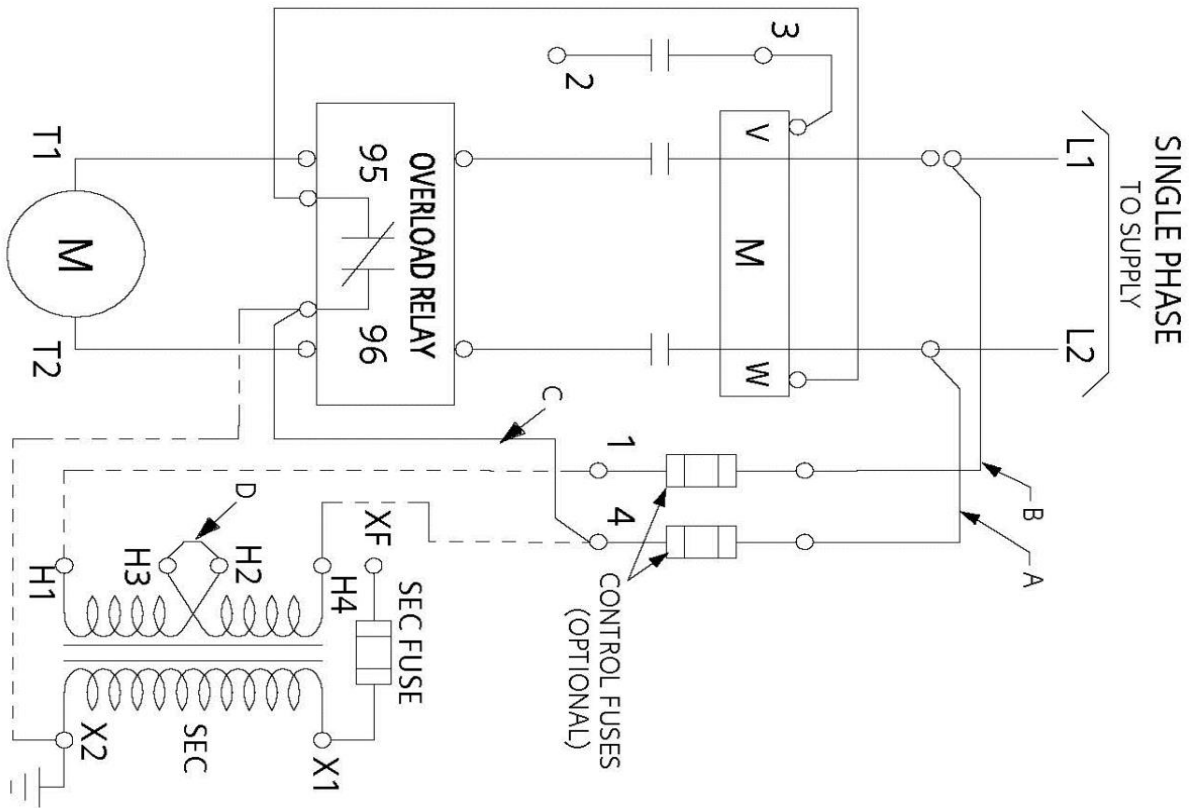
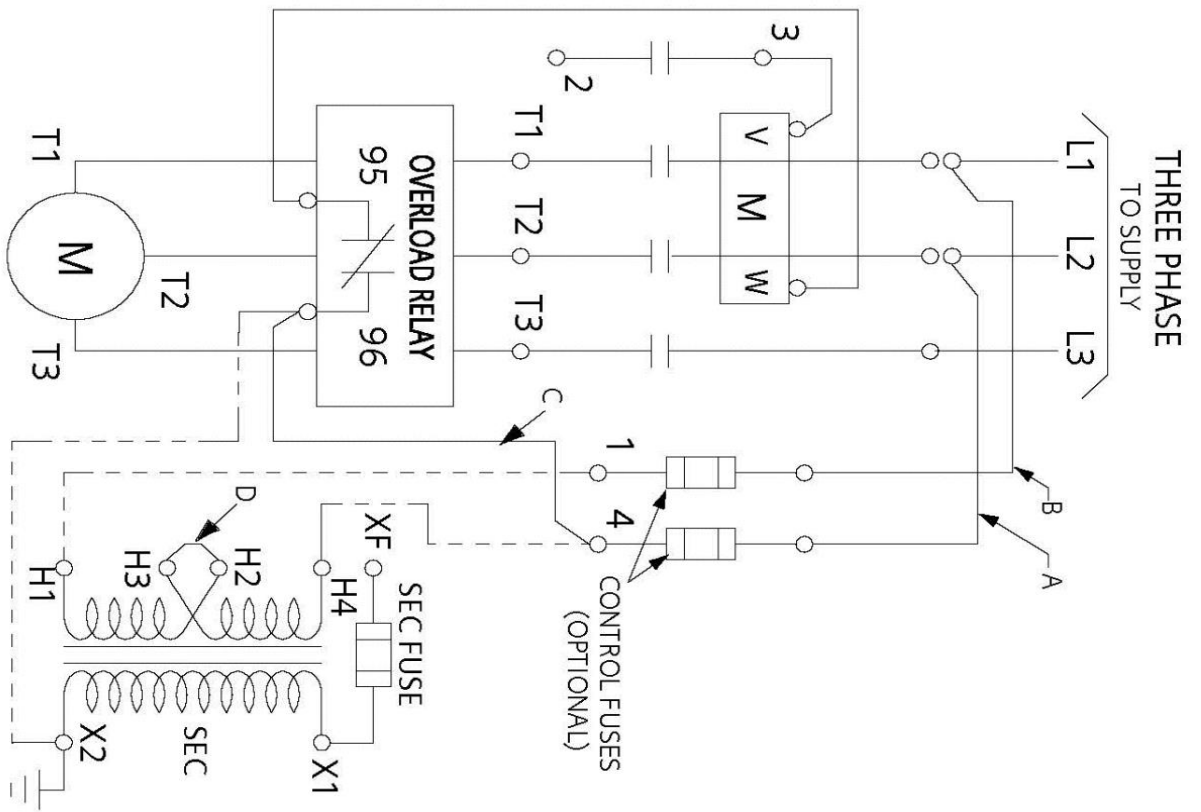

REF. D46590001