

SENTRON, Fuse switch disconnecter 3NP1, 3-pole, NH00, 160 A, for Busbar system 8US 60 mm, flat terminal, Cover level 32/70 mm



Model	
Product brand name	SENTRON
Product designation	3NP1 fuse switch disconnecter
Design of the product	cover level 32/70 mm
Busbar design	busbar thickness 5 or 10 mm
Design of the safety monitoring	Without
Design of the operating mechanism	Cover handle
Design of the load switch / Strip form	No
Type of the driving mechanism / motor drive	No
General technical data	
Number of poles	3
Type of device	For 60 mm 8US busbar system
Size of disconnecting link	00 and 000
Size of fuse link	NH000, NH00
Continuous current / at 35 °C / rated value	160 A
Let-through current / with closed switch / maximum permissible	23 kA
cut-off value $I^{*2}t_{max.}$ / 500 V	158 000 A ² ·s
Power factor	

<ul style="list-style-type: none"> • at AC-22 B 	0.65
<ul style="list-style-type: none"> • at AC-23 B 	0.45
<ul style="list-style-type: none"> • with capacitive load 	-0.25
circuit-breaker / Design	3NP11
Mechanical service life (switching cycles) / typical	2 000
Fuse system	LV HRC fuse

Voltage	
Insulation voltage / rated value	690 V
Power factor / at AC-21 B	0.95
Surge voltage resistance / rated value	8 kV

Protection class	
Protection class IP	
<ul style="list-style-type: none"> • with closed switch / with cover or cable lug cover 	IP40
<ul style="list-style-type: none"> • with closed switch / without cover or cable lug cover 	IP30
<ul style="list-style-type: none"> • on the front 	IP40
<ul style="list-style-type: none"> • open 	IP20

Electricity	
Continuous current	
<ul style="list-style-type: none"> • rated value 	160 A
<ul style="list-style-type: none"> • at 40 °C / rated value 	155 A
<ul style="list-style-type: none"> • at 45 °C / rated value 	145 A
<ul style="list-style-type: none"> • at 50 °C / rated value 	140 A
<ul style="list-style-type: none"> • at 55 °C / rated value 	133 A
Let-through current / with high-speed activation / maximum permissible	15 kA
Let-through current / I _c / maximum permissible	
<ul style="list-style-type: none"> • 400 V 	23 000 A
<ul style="list-style-type: none"> • 500V 	23 000 A
cut-off value I ² t _{max.} / 400 V	158 000 A ² ·s

Main circuit	
Operating voltage	
<ul style="list-style-type: none"> • at AC / rated value / maximum 	690 V
<ul style="list-style-type: none"> • at DC / rated value 	440 V
<ul style="list-style-type: none"> • at DC / rated value / maximum 	440 V
Operating current / with capacitive load	
<ul style="list-style-type: none"> • at 400 V / maximum 	72 A
<ul style="list-style-type: none"> • at 500 V / maximum 	55 A

Auxiliary circuit	
Number of CO contacts / for auxiliary contacts	0

Number of NC contacts / for auxiliary contacts	0
Number of NO contacts / for auxiliary contacts	0

Suitability

Suitability for use	
• Main switch	No
• switch disconnecter	Yes
• EMERGENCY OFF switch	No
• safety switch	Yes
• maintenance/repair switch	Yes

Product details

Product feature / interlock	Yes
Product component	
• Trip indicator	No
• Phase failure monitoring	No
• undervoltage release	No
• undervoltage release with leading contact	No
Product feature / sealable	Yes
Product extension	
• Auxiliary switch	Yes
• optional	
— locking capability	Yes
— motor drive	No
— Phase failure monitoring	Yes
— fuse monitoring	Yes
— Voltage trigger	No
— Overvoltage protection monitoring	Yes

Product function

Product function	
• fuse monitoring	No
• Overvoltage protection monitoring	No

Short circuit





Conditional short-circuit current (I _q)	
• rated value	80 kA
• at AC / at 500 V / with high-speed activation / rated value	80 kA
• at AC / at 690 V / with high-speed activation / rated value	80 kA
• with closed switch / at AC / at 500 V / rated value	120 kA
• with closed switch / at AC / at 690 V / rated value	120 kA

Connections	
Arrangement of electrical connectors / for main current circuit	other
Connectable conductor cross-section / for main contacts	
<ul style="list-style-type: none"> • single or multi-stranded / minimum 	2.5 mm ²
<ul style="list-style-type: none"> • single or multi-stranded / maximum 	95 mm ²
<ul style="list-style-type: none"> • stranded / minimum 	2.5 mm ²
<ul style="list-style-type: none"> • stranded / maximum 	95 mm ²
Tightening torque / with screw-type terminals	
<ul style="list-style-type: none"> • minimum 	10 N·m
<ul style="list-style-type: none"> • maximum 	12 N·m
Type of electrical connection / for main current circuit	busbar connection

Mechanical Design	
Height	210.4 mm
Width	105.8 mm
Depth	137.5 mm
Mounting position	horizontal/vertical
Mounting type	busbar
Mounting type	
<ul style="list-style-type: none"> • floor mounting 	No
<ul style="list-style-type: none"> • front mounting 	No
<ul style="list-style-type: none"> • front mounting with 4-hole attachment 	No
<ul style="list-style-type: none"> • front mounting with central attachment 	No
<ul style="list-style-type: none"> • rail mounting 	Yes
Busbar center-to-center spacing	60 mm
Net weight	0.98 kg

Environmental conditions	
Degree of pollution	3
Ambient temperature	
<ul style="list-style-type: none"> • during operation / minimum 	-25 °C
<ul style="list-style-type: none"> • during operation / maximum 	55 °C
<ul style="list-style-type: none"> • during storage / minimum 	-50 °C
<ul style="list-style-type: none"> • during storage / maximum 	80 °C

Certificates	
Reference code	
<ul style="list-style-type: none"> • acc. to DIN EN 61346-2 	Q
<ul style="list-style-type: none"> • acc. to DIN EN 81346-2 	Q

General Product Approval			Declaration of Conformity	Test Certificates
 CCC	 UR	 VDE	Miscellaneous	 EG-Konf.
				Type Test Certificates/Test Report

Test Certificates	Shipping Approval
Special Test Certificate	 LRS

Further information

Information- and Downloadcenter (Catalogs, Brochures,...)

<http://www.siemens.com/lowvoltage/catalogs>

Industry Mall (Online ordering system)

<https://mall.industry.siemens.com/mall/en/en/Catalog/product?mlfb=3NP1133-1BC10>

Service&Support (Manuals, Certificates, Characteristics, FAQs,...)

<https://support.industry.siemens.com/cs/ww/en/ps/3NP1133-1BC10>

Image database (product images, 2D dimension drawings, 3D models, device circuit diagrams, ...)

http://www.automation.siemens.com/bilddb/cax_en.aspx?mlfb=3NP1133-1BC10

CAX-Online-Generator

<http://www.siemens.com/cax>

Tender specifications

<http://www.siemens.com/specifications>

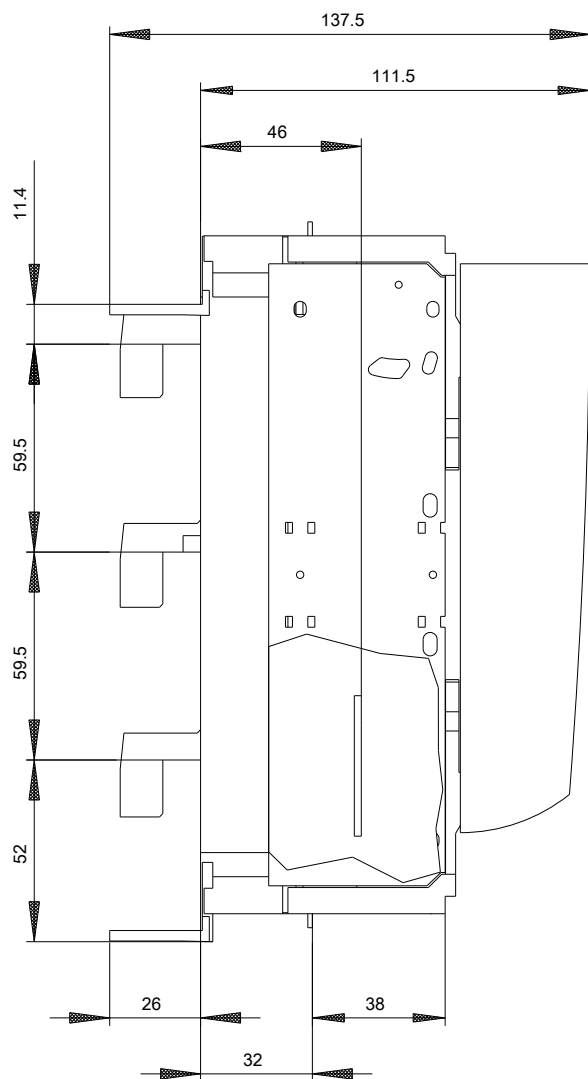
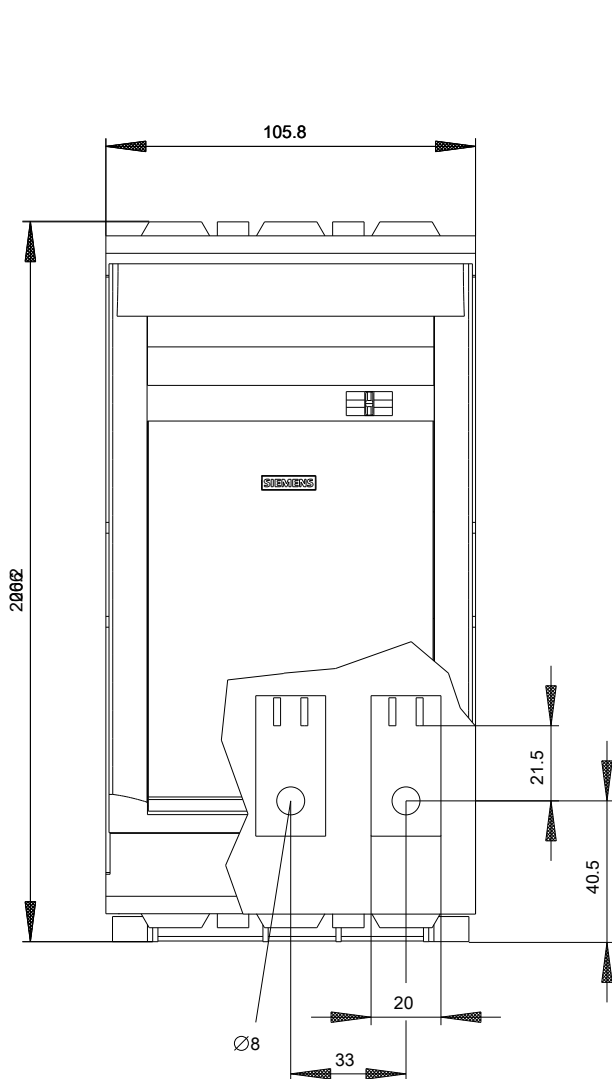

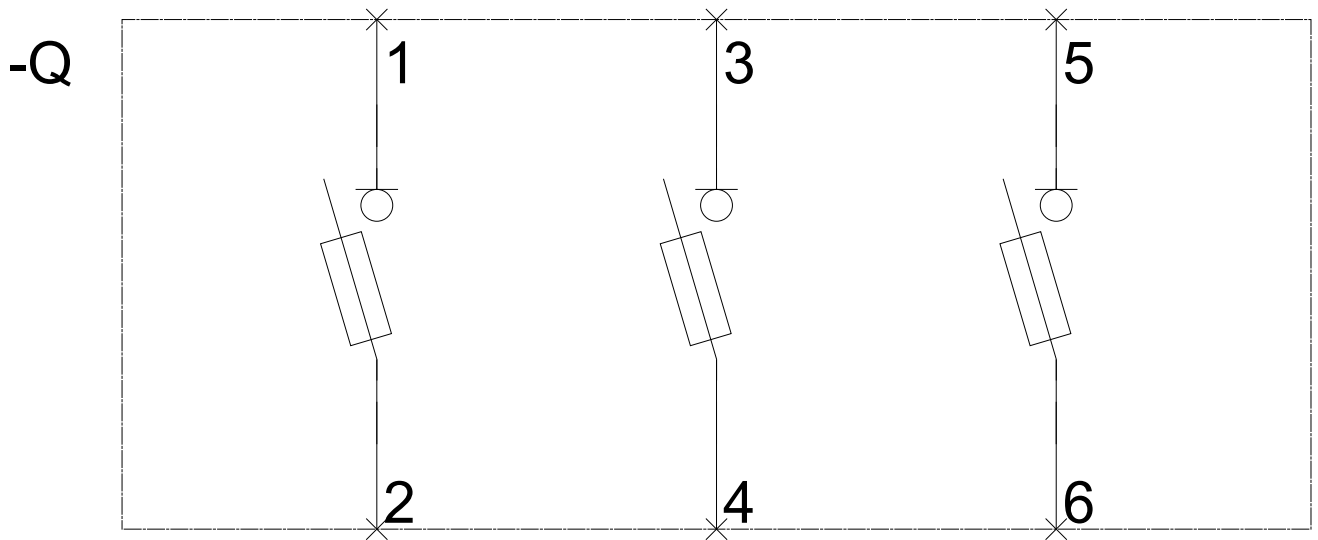

-CB

