

CIRCUIT BREAKER 3VA6 UL FRAME 400 BREAKING CAPACITY CLASS H 65KA @ 480V 3-POLE, LINE PROTECTION ETU320, LI, IN=400A OVERLOAD PROTECTION IR=160A ...400A SHORT CIRCUIT PROTECTION II=1,5...10 X IN W/O CONNECTION



Model	
product brandname	SENTRON
Product designation	Molded-case circuit breaker
Design of the product	System protection
Type of load switch / according to UL 489 / Heating, Air Conditioning, and Refrigeration circuit breaker (HACR Type)	Yes
Design of the overcurrent release	ETU320
Protective function of the overcurrent release	LI
Number of poles	3

General technical data	
Tension assignée d'isolement U_i	600 V
Max. rated operational voltage U_e with AC 50/60Hz	600 V
Active power loss / for rated value of the current / at AC / in hot operating state / per device	70 W
Active power loss / for rated value of the current / at AC / in hot operating state / per pole	23.33 W
Mechanical service life (switching cycles) / typical	15 000

Electrical endurance (switching cycles) / at AC-1 / at 380/415 V 50/60 Hz	6 000
Electrical endurance (switching cycles) / at AC-1 / at 690 V 50/60 Hz	4 000
Electrical lifetime (switching cycles) / at 480 V / at 50/60 Hz	6 000
Electrical lifetime (switching cycles) / at 600 V / at 50/60 Hz	6 000
Neutral conductors / upgradeable/retrofitable	No
Ground fault monitoring version	Without
Product function	
• communication function	No
• other measurement function	No

Electricity

Marking / according to UL 489 / 100%-rated breaker	No
Max. rated operational voltage of the size of the circuit-breaker	400 A
Courant permanent assigné lu	400 A
Operating current	
• at 40 °C	400 A
• at 45 °C	400 A
• at 50 °C	400 A
• at 55 °C	385 A
• at 60 °C	380 A
• at 65 °C	355 A
• at 70 °C	340 A

Switching capacity according to IEC 60947

Switching capacity class of the circuit breaker	H
Maximum short-circuit current breaking capacity (I _{cu})	
• at 240 V	110 kA
• at 415 V	85 kA
• at 690 V	5 kA
Operational short-circuit current breaking capacity (I _{cs})	
• at 240 V	110 kA
• at 415 V	85 kA
• at 690 V	5 kA
Short-circuit current making capacity (I _{cm})	
• at 240 V	242 kA
• at 415 V	187 kA
• at 690 V	7.5 kA

Switching capacity according to UL 489

Breaking capacity current	
<ul style="list-style-type: none"> • at 240 V • at 480 Y/277 V • at 480 V • at 600 Y/347 V • at 600 V 	100 kA 65 kA 65 kA 22 kA 22 kA

Adjustable parameters	
Adjustable response value current / I _g min.	150 A
Adjustable response value current / I _g min.	400 A
Adjustable response value current / I _g min.	0.5
Adjustable response value current / I _g min.	17
Adjustable response value current / I _i min.	600 A
Adjustable response value current / I _i max.	4 000 A
Ground fault protection / tripping switchable / I _{2t} =ON/OFF	No

Mechanical Design	
Height [in]	9.8 in
Height	248 mm
Width [in]	5.4 in
Width	138 mm
Depth [in]	4.3 in
Depth	110 mm

Connections	
Arrangement of electrical connectors / for main current circuit	Without connection
Type of electrical connection / for main current circuit	Without

Auxiliary circuit	
Number of CO contacts / for auxiliary contacts	0







Accessories	
Product extension / optional / motor drive	Yes

Environmental conditions	
Protection class IP / on the front	IP40
Ambient temperature	
<ul style="list-style-type: none"> • during operation / minimum • during operation / maximum • during storage / minimum • during storage / maximum 	-25 °C 70 °C -40 °C 80 °C

Certificates	
Equipment marking / acc. to DIN EN 81346-2	Q

Certificate of suitability / as approval for NAVAL (no combat vessels) / Supplement SB

No

General Product Approval	EMC	Declaration of Conformity	Shipping Approval		
 CSA	 UL	 EAC	 RCM	 EG-Konf.	 ABS

other

[sonstig](#)

Further information

Information- and Downloadcenter (Catalogs, Brochures,...)

<http://www.siemens.com/lowvoltage/catalogs>

Industry Mall (Online ordering system)

<https://mall.industry.siemens.com/mall/en/en/Catalog/product?mlfb=3VA6340-6HL31-0AA0>

Service&Support (Manuals, Certificates, Characteristics, FAQs,...)

<http://support.automation.siemens.com/WW/view/en/3VA6340-6HL31-0AA0/all>

Image database (product images, 2D dimension drawings, 3D models, device circuit diagrams, ...)

http://www.automation.siemens.com/bilddb/cax_en.aspx?mlfb=3VA6340-6HL31-0AA0

CAX-Online-Generator

<http://www.siemens.com/cax>

Tender specifications

<http://www.siemens.com/specifications>

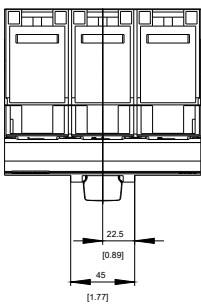
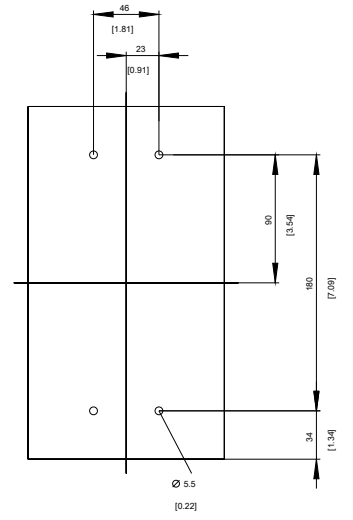
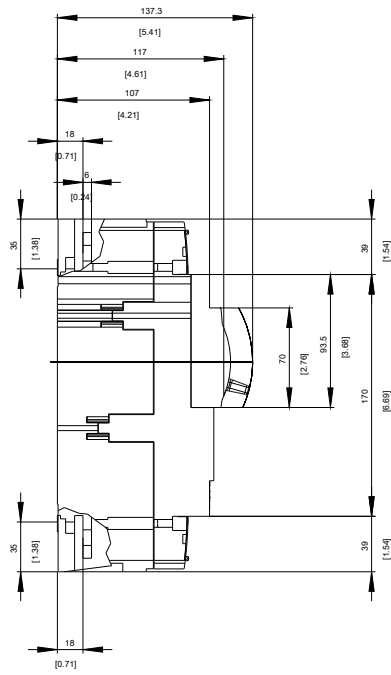
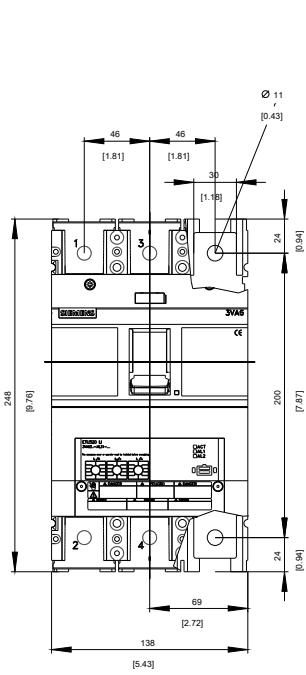

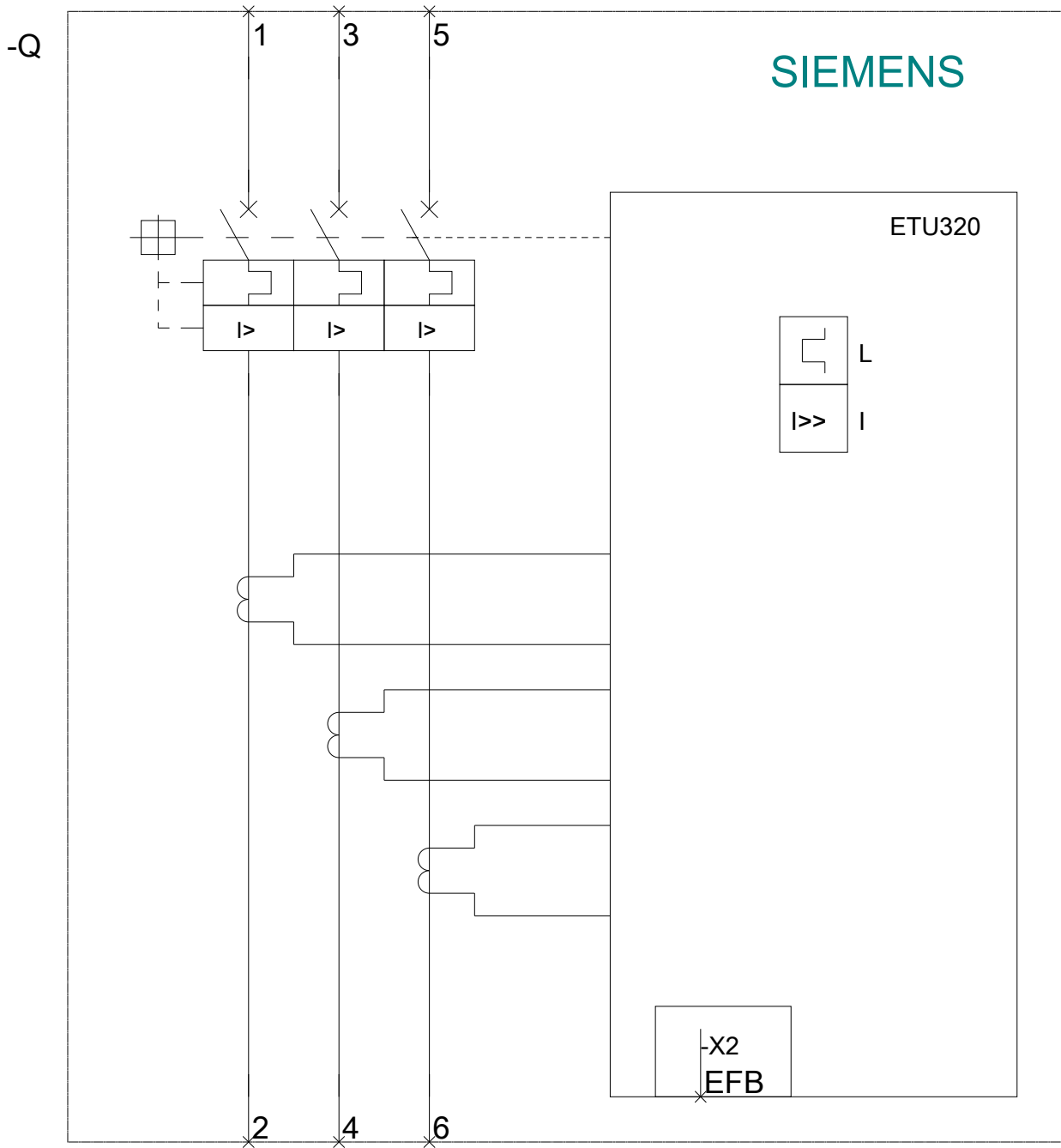

last modified:

04/14/2017