

3-PHASE INFEED TERMINAL FOR 3-PHASE BUSBARS, FOR SELF-PROTECTED COMBINATION MOTOR CONTROLLER (TYPE E), FOR CIRCUIT-BREAKERS 3RV SIZE S00/S0,

General technical data:

product brand name		SIRIUS
Product designation		Three-phase feeder terminal
Design of the product		from above, Type E, size S0/S00
Size of the circuit-breaker		S00, S0
Protection class IP on the front		IP20
Insulation voltage with degree of pollution 3 Rated value	V	690
Ambient temperature		
• during storage	°C	-50 ... +80
• during operation	°C	-20 ... +60
Ampacity maximum	A	63

Installation/ mounting/ dimensions:

Width	mm	44
Height	mm	44.5
Depth	mm	32

Connections/ Terminals:

Type of electrical connection for main current circuit		screw-type terminals
Type of connectable conductor cross-section		
• for main contacts		
— solid		1x (2.5 ... 16 mm ²)
— stranded		1x (2.5 ... 25 mm ²)
— finely stranded		
— with core end processing		1x (2.5 ... 16 mm ²)





• for AWG conductors for main contacts

1x (10 ... 4)

Certificates/ approvals:

Certificate of suitability

CE / UL / CSA / CCC

General Product Approval	Declaration of Conformity	Test Certificates		Shipping Approval	
 CSA	 UL	 EG-Konf.	Special Test Certificate	Type Test Certificates/Test Report	 ABS

Shipping Approval



Shipping Approval	other				
 RMRS	Confirmation	Environmental Confirmations	 VDE	other	

Further information

Information- and Downloadcenter (Catalogs, Brochures,...)

<http://www.siemens.com/industrial-controls/catalogs>

Industry Mall (Online ordering system)

<http://www.siemens.com/industrymall>

Cax online generator

<http://support.automation.siemens.com/WW/CAXorder/default.aspx?lang=en&mlfb=3RV29255EB>

Service&Support (Manuals, Certificates, Characteristics, FAQs,...)

<https://support.industry.siemens.com/cs/ww/en/ps/3RV29255EB>

Image database (product images, 2D dimension drawings, 3D models, device circuit diagrams, EPLAN macros, ...)

http://www.automation.siemens.com/bilddb/cax_de.aspx?mlfb=3RV29255EB&lang=en

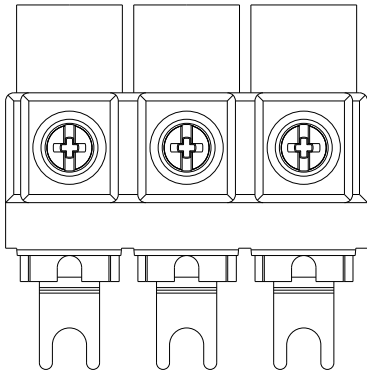

last modified:

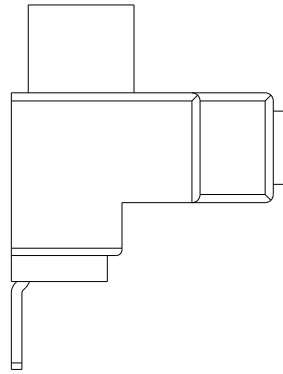

20.04.2015