

Aluminum with/without Cover & Gasket

Images

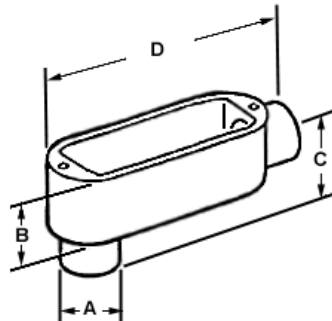

Application

Threaded bodies for rigid conduit or IMC allows access for inspection, pulling and maintenance.

Product Information

Material: Aluminum
Finish: Enamel paint

Certifications & Codes:

Federal Specification Number:	W-C-586D
NEMA Standard:	FB-1
UL File Number:	E11077
UL Standard:	UL-514A
UNSPSC:	39131708

[Download Photo Image](#)

[Download Dimensional Image](#)

Dimension A in Inches: 1-9/16
Dimension B in Inches: 1-5/8
Dimension C in Inches: 1-1/2
Dimension D in Inches: 5-1/8

Catalog ID: LB-42

UPC Number: 781747041425

Description: Rigid and IMC Conduit Body, Type LB, Aluminum, Size 3/4 Inch

Application: Threaded bodies for rigid conduit or IMC allows access for inspection, pulling and maintenance.

Trade Size: 3/4"

Std Pkg Qty: 60

Unit Qty: 10