

Arrow Hart
Pin & sleeve devices

Arrow Hart

IP69K Certified

EATON

Powering Business Worldwide

Arrow Hart

Arrow Hart's pin & sleeve devices and mechanical interlocks

Table of Contents

IP69K testing	3	Pin & sleeve mechanical interlocks	11-13
Pin & sleeve introduction	4-5	20A Mechanical Interlocks	12
Understanding IEC 309 catalog numbers	6	30A Mechanical Interlocks	12
How to order pin & sleeve	7	60A Mechanical Interlocks	13
Pin & sleeve devices	8-9	100A Mechanical Interlocks	13
20A Receptacles, plugs, connectors & inlets	8	Pin & sleeve dimensional data	14-17
30A Receptacles, plugs, connectors & inlets	8	16/20A & 30/32A dimensional data	14
60A Receptacles, plugs, connectors & inlets	8	60/63A & 100/125A dimensional data	15
100A Receptacles, plugs, connectors & inlets	8	Accessory dimensional data	16
16A Receptacles, plugs, connectors & inlets	9	Mechanical interlock dimensional data	16-17
32A Receptacles, plugs, connectors & inlets	9	Horsepower Rating	18
63A Receptacles, plugs, connectors & inlets	9	Specification information	19-27
125A Receptacles, plugs, connectors & inlets	9		
Pin & Sleeve Device Accessories	10		

IP69K
certified



Pin & sleeve devices

Sturdy nylon construction, rugged design with corrosion resistant components for lasting electrical performance. Watertight sealing that provides IP69K protection so you can feel confident in even the most severe washdown environments.



Pin & sleeve mechanical interlocks

Factory-wired in a single unit for easy installation, our watertight pin & sleeve mechanical interlocks provide an interlocked switch and overload protection within an enclosure that prevents plugs from being engaged or disengaged under load.

The IP69K test was designed specifically for rating protection against a high pressure jet stream (1160 to 1450 psi), high liquid temperature (176°F) and close nozzle distances (4" to 6") from the device surface

What does IP69K testing mean to you

The IP69K rating is designed to tackle high pressure, high temperature washdown applications. The "6" applies to external protection from dust. The "9" signifies protection from close-range high pressure spray downs, and the "K" applies to the high temperature of the water used. Arrow Hart's new pin & sleeve devices are designed to face some of the most severe operating conditions, often in the most challenging environments making them ideal for a wide range of markets, including food and beverage, mining, and industrial facilities.

How IP69K testing works

To obtain an IP69K protection rating – a strong water jet is directed at the device from 4 directions and to achieve the rating it must not have any harmful effects. A jet nozzle at 0°, 30°, 60° and 90° to the rotating table at 176°F, 4–6 inches away at 1160–1450psi. The test time is 2 minutes.

IP69K test

Water Temperature = 176°F (80°C)

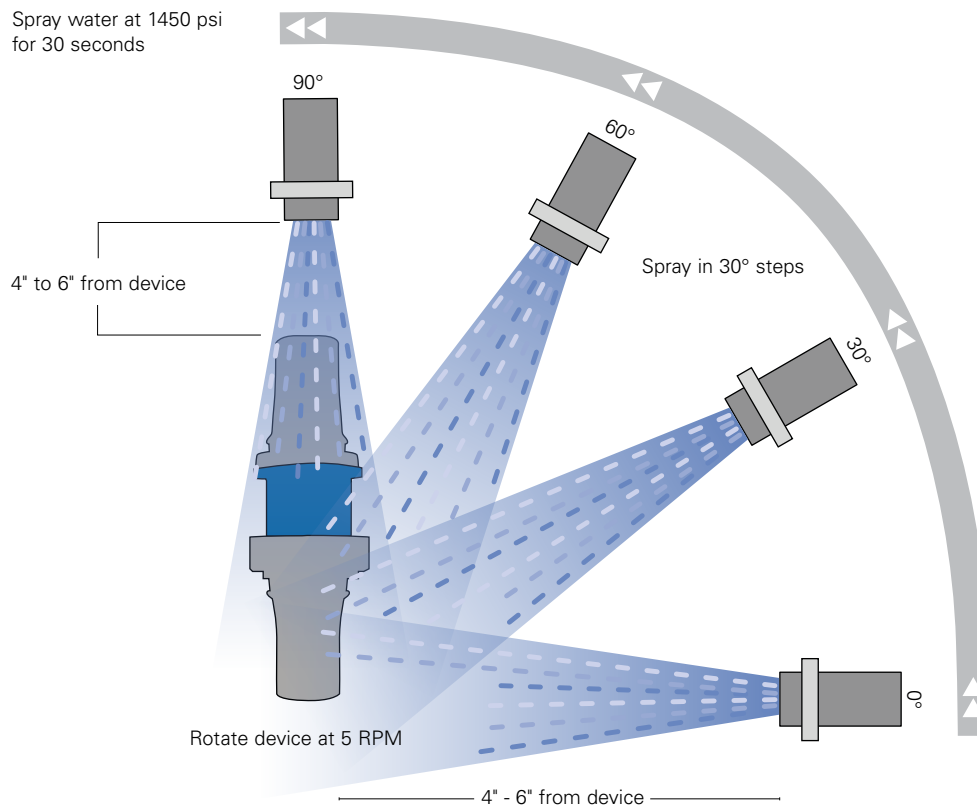

After testing, water must not be present inside the device

IP69K certified

- 1 The IP69K standard requires the water pressure to be between 1160-1450 psi, at a rate of about 4 gallons/minute, and at the temperature of 176°F
- 2 The nozzle from which the water is sprayed is between 4 and 6 inches from device
- 3 Spray is applied at angles of 0°, 30°, 60°, and 90° for duration of 30 seconds at each angle, while the product is rotated at 5 RPM
- 4 IP69K ratings mean product is dust tight and protected against effects of high pressure, high temperature liquids

IP69K pin & sleeve plugs

The industry's first pin & sleeve devices that are designed to address high pressure, high temperature washdown applications



Arrow Hart's new pin and sleeve devices are unlike other brands - our devices are the industry's first to offer IP69K rated protection. Each device has been carefully engineered to offer reliability, efficiency, and added safety protection in demanding wet locations, particularly where harsh washdowns are a must!

Pin & sleeve plugs features & benefits

Mechanical cord clamp with silicone grommet seal and locking screw ensures a positive and watertight strain relief system

Tri-Combo Cord Grip screws for convenience

Durable impact resistant thermoplastic body

Color-coded front housing for easy and accurate identification of voltages

Oversized grounding pin assures mating only with oversized female grounding sleeve; staggered contact to ensure ground makes first and breaks last

Engineered thermoplastic material improves cold impact performance for 60A & 100A devices

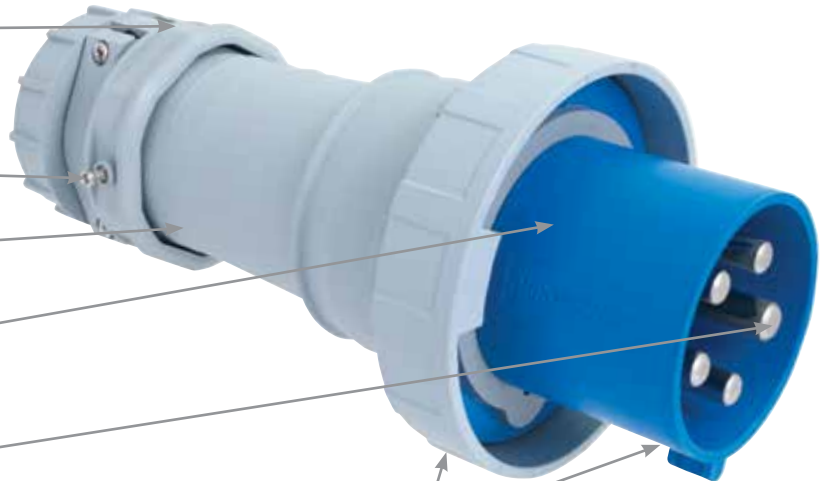

Nickel plated pins offer long life corrosion protection



Threaded NPT cable entry provides efficient means of attaching flexible conduit or wire mesh grips



Pins fully shrouded for mechanical protection; lockout hole for plugs



Tapered wiring pockets to ease insertion of stranded wire; deep pockets with clear markings keep bare conductors isolated

IP69K pin & sleeve receptacles

Pin & sleeve receptacles features & benefits

IP69K
certified

Spring-loaded self-closing cap with silicone gasket protects contacts when not in use. Watertight cap meets IP67 and IP69K protection standards

Rugged materials selected for use in wet locations; provides corrosion resistance

Standard mounting footprints and blind holes provide interchangeability with major brands



Individual Silicone Sealing Grommets with cord diameter range makes for faster, easier assembly



Impact-resistant thermoplastic contact carrier provides superior electrical insulation and V0 flammability rating*



Nickel plated contacts with self-cleaning field-proven pressure bands for smooth pin insertion, low heat rise, corrosion resistance, and quality electrical performance

*Does not include 20/30A Inlets

How to order from the complete line of pin & sleeve products

Understanding IEC 309 pin & sleeve device and mechanical interlock catalog numbers

Pin & sleeve devices

**Pin & sleeve device
sample number:**
AH420P7W

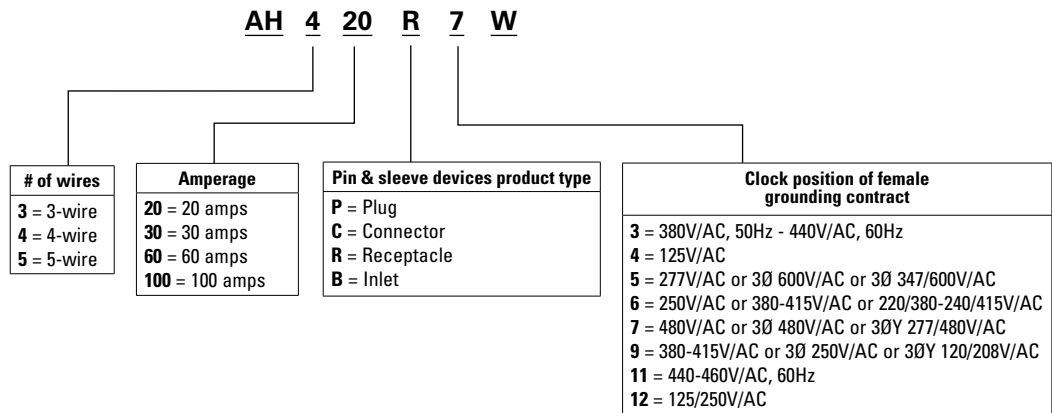

Note:
Exceptions for pin & sleeve devices:
Not every clock face position available for each pole/amp/device combo.
Consult your Eaton wiring devices representative for details.

Pin & sleeve mechanical interlock devices

**Pin & sleeve mechanical
interlock device
sample number:**
CD360MIF4W

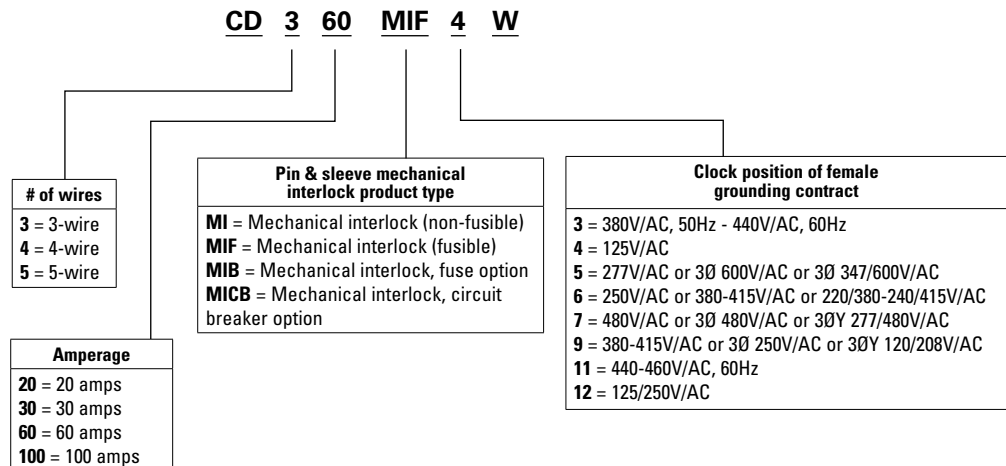

Notes:
Exceptions for mechanical interlock:
HMI available only on 20A.
MIF available only on 30A & 60A
MIB & MICB available only on 20A, 30A & 60A
Not every clock face position available for each pole/amp/device combo.
Consult your Eaton wiring devices representative for details.

Pin and sleeve configurations

Understanding pin & sleeve configurations

Arrow Hart's full line of pin & sleeve products meet or exceed the rigorous IEC 309-1 and 309-2 watertight requirements, and as such are intermateable with all other non-hazardous IEC 309 devices.

A "clock face" is used to represent the grounding contact position for all female connectors and receptacles. With the keyway at the bottom, the female grounding contact will appear at one of the twelve "hour" positions. To identify the system's voltage, identify the housing color and hour location of the connector or receptacle grounding outlet.

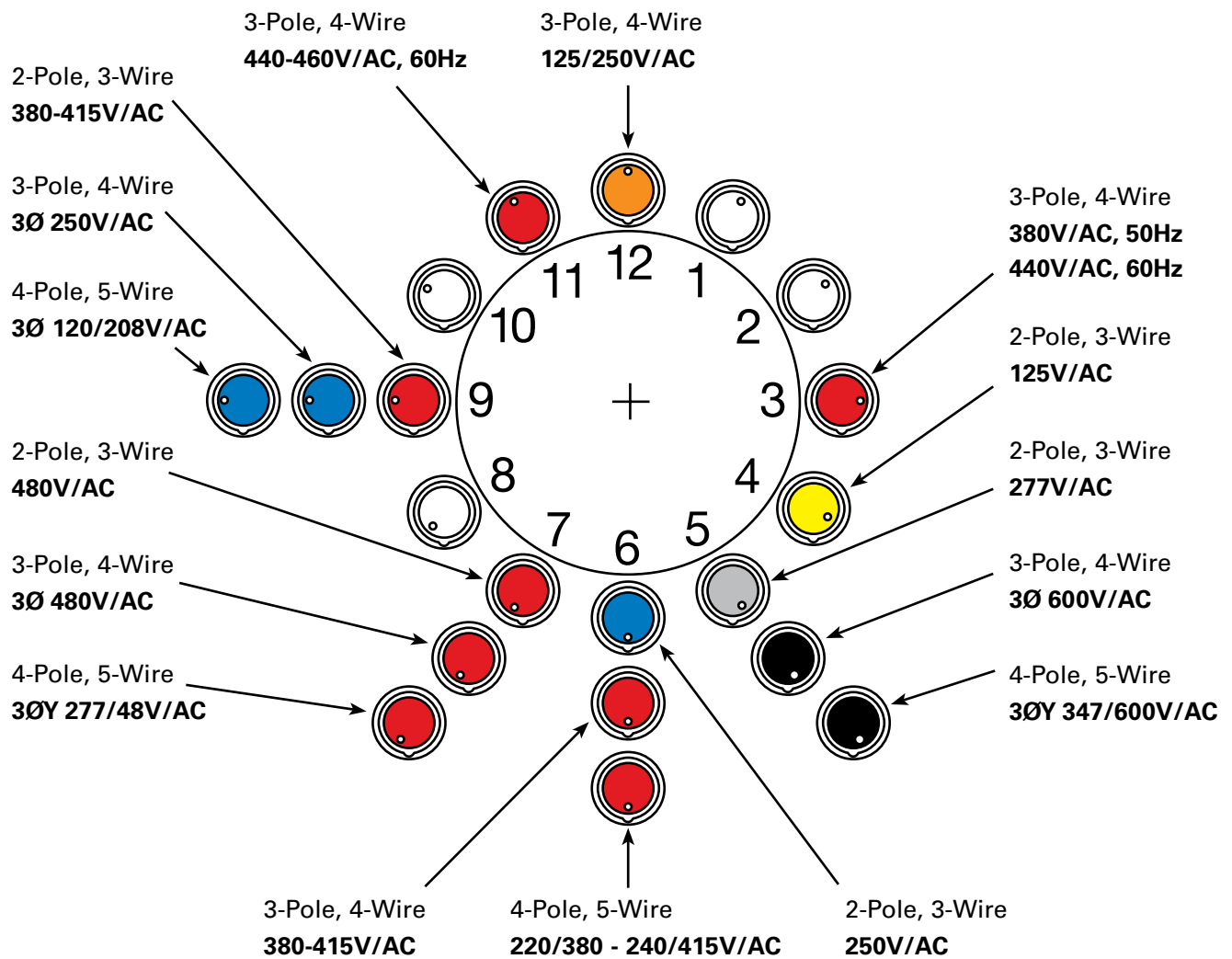

Examples of pin & sleeve connectors with their corresponding wiring diagrams

AH560C9W
 4-Pole, 5-Wire
3Ø 120/208V/AC
 Wiring diagram indicating contact position

AH4125C6W
 3-Pole, 4-Wire
380-415V/AC
 Wiring diagram indicating contact position

AH320C4W
 2-Pole, 3-Wire
125V/AC
 Wiring diagram indicating contact position

IEC 309 watertight pin & sleeve devices

Product description

North American 20A, 30A, 60A & 100A for receptacles, plugs, connectors & inlets



Receptacle



Plug



Connector



Inlet



Angled Receptacle

Rating A	Poles/wires	V/AC, color coding & configurations	Receptacle catalog no.	Plug catalog no.	Connector catalog no.	Inlet catalog no.	15° Angled Receptacle catalog no.	
20	2-P, 3-W	125	AH320R4W	AH320P4W	AH320C4W	AH320B4W	—	
		250	AH320R6W	AH320P6W	AH320C6W	AH320B6W	—	
		480	AH320R7W	AH320P7W	AH320C7W	AH320B7W	—	
	3-P, 4-W	125/250	AH420R12W	AH420P12W	AH420C12W	AH420B12W	—	
		3Ø 250	AH420R9W	AH420P9W	AH420C9W	AH420B9W	—	
		3Ø 480	AH420R7W	AH420P7W	AH420C7W	AH420B7W	—	
		3Ø 600	AH420R5W	AH420P5W	AH420C5W	AH420B5W	—	
	4-P, 5-W	3ØY 120/208	AH520R9W	AH520P9W	AH520C9W	AH520B9W	—	
		3ØY 277/480	AH520R7W	AH520P7W	AH520C7W	AH520B7W	—	
		3ØY 347/600	AH520R5W	AH520P5W	AH520C5W	AH520B5W	—	
	30	2-P, 3-W	125	AH330R4W	AH330P4W	AH330C4W	AH330B4W	—
			250	AH330R6W	AH330P6W	AH330C6W	AH330B6W	—
480			AH330R7W	AH330P7W	AH330C7W	AH330B7W	—	
3-P, 4-W		125/250	AH430R12W	AH430P12W	AH430C12W	AH430B12W	—	
		3Ø 250	AH430R9W	AH430P9W	AH430C9W	AH430B9W	—	
		3Ø 480	AH430R7W	AH430P7W	AH430C7W	AH430B7W	—	
		3Ø 600	AH430R5W	AH430P5W	AH430C5W	AH430B5W	—	
4-P, 5-W		3ØY 120/208	AH530R9W	AH530P9W	AH530C9W	AH530B9W	—	
		3ØY 277/480	AH530R7W	AH530P7W	AH530C7W	AH530B7W	—	
		3ØY 347/600	AH530R5W	AH530P5W	AH530C5W	AH530B5W	—	
60		2-P, 3-W	125	AH360R4W	AH360P4W	AH360C4W	AH360B4W	—
			250	AH360R6W	AH360P6W	AH360C6W	AH360B6W	—
	480		AH360R7W	AH360P7W	AH360C7W	AH360B7W	—	
	3-P, 4-W	125/250	AH460R12W	AH460P12W	AH460C12W	AH460B12W	—	
		3Ø 250	AH460R9W	AH460P9W	AH460C9W	AH460B9W	—	
		3Ø 480	AH460R7W	AH460P7W	AH460C7W	AH460B7W	—	
		3Ø 600	AH460R5W	AH460P5W	AH460C5W	AH460B5W	—	
	4-P, 5-W	3ØY 120/208	AH560R9W	AH560P9W	AH560C9W	AH560B9W	AH560R9W-15	
		3ØY 277/480	AH560R7W	AH560P7W	AH560C7W	AH560B7W	—	
		3ØY 347/600	AH560R5W	AH560P5W	AH560C5W	AH560B5W	—	
	100	2-P, 3-W	125	AH3100R4W	AH3100P4W	AH3100C4W	AH3100B4W	—
			250	AH3100R6W	AH3100P6W	AH3100C6W	AH3100B6W	—
480			AH3100R7W	AH3100P7W	AH3100C7W	AH3100B7W	—	
3-P, 4-W		125/250	AH4100R12W	AH4100P12W	AH4100C12W	AH4100B12W	AH4100R12W-15	
		3Ø 250	AH4100R9W	AH4100P9W	AH4100C9W	AH4100B9W	—	
		3Ø 480	AH4100R7W	AH4100P7W	AH4100C7W	AH4100B7W	AH4100R7W-15	
		3Ø 600	AH4100R5W	AH4100P5W	AH4100C5W	AH4100B5W	—	
4-P, 5-W		3ØY 120/208	AH5100R9W	AH5100P9W	AH5100C9W	AH5100B9W	AH5100R9W-15	
		3ØY 277/480	AH5100R7W	AH5100P7W	AH5100C7W	AH5100B7W	AH5100R7W-15	
		3ØY 347/600	AH5100R5W	AH5100P5W	AH5100C5W	AH5100B5W	—	

IEC309 watertight pin & sleeve devices

Product description

International 16A, 32A, 63A & 125A for receptacles, plugs, connectors & inlets



Receptacle



Plug



Connector



Inlet

Rating A	Poles/wires	V/AC, color coding & configurations	Receptacle catalog no.	Plug catalog no.	Connector catalog no.	Inlet catalog no.
16	2-P, 3-W	110-130V	AH316R4W	AH316P4W	AH316C4W	AH316B4W
		220-240V	AH316R6W	AH316P6W	AH316C6W	AH316B6W
	3-P, 4-W	380-415V	AH416R6W	AH416P6W	AH416C6W	AH416B6W
		220/380 240/415	AH516R6W	AH516P6W	AH516C6W	AH516B6W
32	2-P, 3-W	110-130V	AH332R4W	AH332P4W	AH332C4W	AH332B4W
		220-240V	AH332R6W	AH332P6W	AH332C6W	AH332B6W
	3-P, 4-W	380/440V	AH432R3W	AH432P3W	AH432C3W	AH432B3W
		380-415V	AH432R6W	AH432P6W	AH432C6W	AH432B6W
63	2-P, 3-W	220-240V	AH363R6W	AH363P6W	AH363C6W	AH363B6W
		380-415V	AH463R6W	AH463P6W	AH463C6W	AH463B6W
	4-P, 5-W	220/380 240/415	AH563R6W	AH563P6W	AH563C6W	AH563B6W
125	2-P, 3-W	220-240V	AH3125R6W	AH3125P6W	AH3125C6W	AH3125B6W
		380-415V	AH4125R6W	AH4125P6W	AH4125C6W	AH4125B6W
	4-P, 5-W	220/380 240/415	AH5125R6W	AH5125P6W	AH5125C6W	AH5125B6W

Pin & sleeve device accessories

Product description

16/20A, 30/32A, 60/63A & 100/125A for receptacles, plugs, connectors & inlets



AHBB30

Cast aluminum back boxes

Amps	Description	Catalog no.
16/20 & 30/32	For pin & sleeve receptacles & inlets, 15° angled face, 1" (25.4mm) hub footprint: 3.125" x 3.125" (79.4mm x 79.4mm)	<input type="checkbox"/> AHBB30__
60/63	For pin & sleeve receptacles, 15° angled face, 1.5" (38.1mm) hub footprint: 3.875" x 3.875" (98.4 x 98.4mm)	<input type="checkbox"/> AHBB60__
100/125	For pin & sleeve receptacles & inlets, 15° angled face, 2" (50.8mm) hub footprint: 4.870" x 4.870" (123.7 x 123.7mm)	<input type="checkbox"/> AHBB100__



AHBB60

Cast aluminum feed through

Amps	Description	Catalog no.
5.0 total	For pin & sleeve receptacles & inlets, 1" (25.4mm) hub footprint: 3.125" x 3.125" (79.4mm x 79.4mm)	<input type="checkbox"/> AHFTBB1__



AHBB100

Plug & inlet closure caps

Amps	Description	Catalog no.
16/20	For 2-pole, 3-wire pin & sleeve devices	<input type="checkbox"/> CDCP320__
	For 3-pole, 4-wire pin & sleeve devices	<input type="checkbox"/> CDCP420__
	For 4-pole, 5-wire pin & sleeve devices	<input type="checkbox"/> CDCP520__
30/20	For 2-pole, 3-wire and 3-pole, 4-wire pin & sleeve devices	<input type="checkbox"/> CDCP3430__ <input type="checkbox"/> CDCP530__
	For 2-pole, 3-wire, 3-pole, 4-wire and 4-pole, 5-wire pin & sleeve devices	<input type="checkbox"/> CDCP60__
100/125	For 2-pole, 3-wire, 3-pole, 4-wire and 4-pole, 5-wire pin & sleeve devices	<input type="checkbox"/> CDCP100__



AHFTBB1

Pin & sleeve device accessories

Rating amps	Wires	Plug locking ring catalog no.	Inlet locking ring catalog no.	Connector/receptacle catalog no.	Cord clamp assembly catalog no.
16/20	3	<input type="checkbox"/> AHLRP320	<input type="checkbox"/> AHLRI320	<input type="checkbox"/> AHCA320	<input type="checkbox"/> AHCC3420
	4	<input type="checkbox"/> AHLRP420	<input type="checkbox"/> AHLRI420	<input type="checkbox"/> AHCA420	<input type="checkbox"/> AHCC3420
	5	<input type="checkbox"/> AHLRP520	<input type="checkbox"/> AHLRI520	<input type="checkbox"/> AHCA520	<input type="checkbox"/> AHCC520
30/20	3 & 4	<input type="checkbox"/> AHLRP3430	<input type="checkbox"/> AHLRI3430	<input type="checkbox"/> AHCA3430	<input type="checkbox"/> AHCC3430
	5	<input type="checkbox"/> AHLRP530	<input type="checkbox"/> AHLRI530	<input type="checkbox"/> AHCA530	<input type="checkbox"/> AHCC530
60/63	All	<input type="checkbox"/> AHLRP60	<input type="checkbox"/> AHLRI60	<input type="checkbox"/> AHCA60	<input type="checkbox"/> AHCC60
100/125	All	<input type="checkbox"/> AHLRP100	<input type="checkbox"/> AHLRI100	<input type="checkbox"/> AHCA100	<input type="checkbox"/> AHCC100



CDCP100



Connector/receptacle cover assembly



Cord clamp assembly



Inlet locking ring



Plug locking ring

Watertight pin & sleeve mechanical interlocks

Combined pin & sleeve receptacle and disconnect switch

Pin & sleeve mechanical interlocks provide a separate means of disconnect for motor leads. For extra safety and compliance, these interlocks prevent the plug from being engaged or disengaged under load.

Watertight pin & sleeve mechanical interlocks features & benefits



Compact design fits in the web of an I-beam, the smallest footprint in the industry

Switch handles are designed to comply with OSHA lockout/tagout requirements

Unique locking mechanism ensures that switch can only be energized when plug is fully mated

Rugged Valox® housing provides superior corrosion and impact resistance

Hidden hinge system allows full access to internal switch terminations and provides a clean solution in 4x environments

Valox® is a registered trademark of General Electric, USA.



Poured-in seamless gasket and tongue and groove design yields the ultimate seal against moisture and contamination



Dual mounting capability using corner mounting holes or supplied mounting feet



Blank enclosures without pre-drilled entries allow maximum installation flexibility; watertight hub and double grounding blocks provided



Available with option fuses and/or circuit breakers for additional circuit protection

IEC 309 watertight pin & sleeve mechanical interlocks

Product Description

20A and 30A; 2-pole, 3-wire grounding; 3-pole, 4-wire grounding; 4-pole, 5-wire grounding



Horizontal Mechanical Interlock, Non-Fusible



Mechanical Interlock, Fusible or Non-Fusible

Rating A	Poles/wires	HP rating Std/Max*	Receptacle catalog no.	Description	Catalog no.			
20	2-P, 3-W	125		1	Horizontal, Non-Fusible	<input type="checkbox"/> CD320HMI4W		
		250		2.5	Horizontal, Non-Fusible	<input type="checkbox"/> CD320HMI6W		
		480		5	Horizontal, Non-Fusible	<input type="checkbox"/> CD320HMI7W		
	3-P, 4-W	125/250		1; 2.5	Horizontal, Non-Fusible	<input type="checkbox"/> CD420HMI12W		
				0.5; 1	Fused, w/ Access Panel	<input type="checkbox"/> CD420MIB12W		
				0.5; 1	Circuit Breaker, w/ Access Panel	<input type="checkbox"/> CD420MICB12W		
				0.5; 1	Fusible	<input type="checkbox"/> CD420MIF12W		
		3Ø 250		5	Horizontal, Non-Fusible	<input type="checkbox"/> CD420HMI9W		
				5	Fused, w/ Access Panel	<input type="checkbox"/> CD420MIB9W		
				5	Circuit Breaker, w/ Access Panel	<input type="checkbox"/> CD420MICB9W		
				5	Fusible	<input type="checkbox"/> CD420MIF9W		
				3Ø 480		10	Horizontal, Non-Fusible	<input type="checkbox"/> CD420HMI7W
						10	Fused, w/ Access Panel	<input type="checkbox"/> CD420MIB7W
						10	Circuit Breaker, w/ Access Panel	<input type="checkbox"/> CD420MICB7W
						10	Fusible	<input type="checkbox"/> CD420MIF7W
		3Ø 600		10	Horizontal, Non-Fusible	<input type="checkbox"/> CD420HMI5W		
		4-P, 5-W	3ØY 120/208		5	Horizontal, Non-Fusible	<input type="checkbox"/> CD520HMI9W	
		30	2-P, 3-W	125		2	Non-Fusible	<input type="checkbox"/> CD330MI4W
				250		2	Non-Fusible	<input type="checkbox"/> CD330MI6W
480				2.5/5	Fusible	<input type="checkbox"/> CD330MIF6W		
3-P, 4-W	125/250			10	Non-Fusible	<input type="checkbox"/> CD330MI7W		
				2; 5	Non-Fusible	<input type="checkbox"/> CD430MI12W		
				0.5; 1.5/2; 5	Fusible	<input type="checkbox"/> CD430MIF12W		
				1; 3	Fused, w/ Access Panel	<input type="checkbox"/> CD430MIB12W		
	3Ø 250			1; 3	Circuit Breaker, w/ Access Panel	<input type="checkbox"/> CD430MICB12W		
				10	Non-Fusible	<input type="checkbox"/> CD430MI9W		
				3/7.5	Fusible	<input type="checkbox"/> CD430MIF9W		
				7.5	Fused, w/ Access Panel	<input type="checkbox"/> CD430MIB9W		
				7.5	Circuit Breaker, w/ Access Panel	<input type="checkbox"/> CD430MICB9W		
				3Ø 480		20	Non-Fusible	<input type="checkbox"/> CD430MI7W
						5/15	Fusible	<input type="checkbox"/> CD430MIF7W
						15	Fused, w/ Access Panel	<input type="checkbox"/> CD430MIB7W
	15		Circuit Breaker, w/ Access Panel			<input type="checkbox"/> CD430MICB7W		
	3Ø 600			20	Non-Fusible	<input type="checkbox"/> CD430MI5W		
				7.5/20	Fusible	<input type="checkbox"/> CD430MIF5W		
				4-P, 5-W	3ØY 120/208		7.5	Non-Fusible
7.5							Fused, w/ Access Panel	<input type="checkbox"/> CD530MIB9W
7.5	Circuit Breaker, w/ Access Panel		<input type="checkbox"/> CD530MICB9W					
3ØY 277/480			20				Non-Fusible	<input type="checkbox"/> CD530MI7W
			15				Fused, w/ Access Panel	<input type="checkbox"/> CD530MIB7W
			15	Circuit Breaker, w/ Access Panel	<input type="checkbox"/> CD530MICB7W			
3ØY 347/600		20	Non-Fusible	<input type="checkbox"/> CD530MI5W				
		15	Fused, w/ Access Panel	<input type="checkbox"/> CD530MIB5W				
		15	Circuit Breaker, w/ Access Panel	<input type="checkbox"/> CD530MICB5W				

Note: *See page 17 for horse power rating.

IEC 309 watertight pin & sleeve mechanical interlocks

Product Description

60A and 100A; 2-pole, 3-wire grounding; 3-pole, 4-wire grounding; 4-pole, 5-wire grounding



Mechanical interlock, fuse or circuit breaker with access panel

Rating A	Poles/wires	V/AC, color coding & configurations	HP rating Std/Max*	Description	Catalog no.		
60	2-P, 3-W	250	10	Non-fusible	<input type="checkbox"/> CD360MI6W		
			3/10	Fusible	<input type="checkbox"/> CD360MIF6W		
		480	20	Non-fusible	<input type="checkbox"/> CD360MI7W		
	3-P, 4-W	125/250	3; 10	Non-fusible	<input type="checkbox"/> CD460MI12W		
			1.5; 3/3; 10	Fusible	<input type="checkbox"/> CD460MIF12W		
			2.5; 7.5	Fused, w/ access panel	<input type="checkbox"/> CD460MIB12W		
			2.5; 7.5	Circuit breaker, w/ access panel	<input type="checkbox"/> CD460MICB12W		
			3Ø 250	20	Non-fusible	<input type="checkbox"/> CD460MI9W	
		7.5/15	Fusible	<input type="checkbox"/> CD460MIF9W			
		15	Fused, w/ access panel	<input type="checkbox"/> CD460MIB9W			
		15	Circuit breaker, w/ access panel	<input type="checkbox"/> CD460MICB9W			
		3Ø 480	40	Non-fusible	<input type="checkbox"/> CD460MI7W		
	15/30		Fusible	<input type="checkbox"/> CD460MIF7W			
	30		Fused, w/ access panel	<input type="checkbox"/> CD460MIB7W			
	30		Circuit breaker, w/ access panel	<input type="checkbox"/> CD460MICB7W			
	3Ø 600		50	Non-fusible	<input type="checkbox"/> CD460MI5W		
			15/30	Fusible	<input type="checkbox"/> CD460MIF5W		
		35	Fused, w/ access panel	<input type="checkbox"/> CD460MIB5W			
	35	Circuit breaker, w/ access panel	<input type="checkbox"/> CD460MICB5W				
	4-P, 5-W	3ØY 120/208	20	Non-fusible	<input type="checkbox"/> CD560MI9W		
			7.5/15	Fusible	<input type="checkbox"/> CD560MIF9W		
15			Fused, w/ access panel	<input type="checkbox"/> CD560MIB9W			
15			Circuit breaker, w/ access panel	<input type="checkbox"/> CD560MICB9W			
3ØY 277/480			40	Non-fusible	<input type="checkbox"/> CD560MI7W		
			15/30	Fusible	<input type="checkbox"/> CD560MIF7W		
		30	Fused, w/ access panel	<input type="checkbox"/> CD560MIB7W			
		30	Circuit breaker, w/ access panel	<input type="checkbox"/> CD560MICB7W			
		3ØY 347/600	50	Non-fusible	<input type="checkbox"/> CD560MI5W		
			15/50	Fusible	<input type="checkbox"/> CD560MIF5W		
100			2-P, 3-W	125	15	Non-fusible	<input type="checkbox"/> CD3100MI4W
				250	15	Non-fusible	<input type="checkbox"/> CD3100MI6W
	480			30	Non-fusible	<input type="checkbox"/> CD3100MI7W	
	3-P, 4-W		125/250	5; 15	Non-fusible	<input type="checkbox"/> CD4100MI12W	
		3Ø 250	25	Non-fusible	<input type="checkbox"/> CD4100MI9W		
		3Ø 480	50	Non-fusible	<input type="checkbox"/> CD4100MI7W		
		3Ø 600	50	Non-fusible	<input type="checkbox"/> CD4100MI5W		
		4-P, 5-W	3ØY 120/208	25	Non-fusible	<input type="checkbox"/> CD5100MI9W	
	3ØY 277/480		50	Non-fusible	<input type="checkbox"/> CD5100MI7W		
3ØY 347/600	50		Non-fusible	<input type="checkbox"/> CD5100MI5W			

Note: *See page 17 for horse power rating.

Dimensional information

Table 1. 16/20A & 30/32A Receptacles

Family	A	B	C	D	E	F	G	H	I	J	K	L	M
16/20A 2-P, 3-W	3.125" (7.94cm)	0.21" (0.54cm)	3.125" (7.94cm)	2.98" (7.57cm)	3.75" (9.52cm)	3.75" (9.52cm)	0.315" (.8cm)	3.15" (8cm)	2.15" (5.47cm)	1.25" (3.18cm)	2.74" (6.96cm)	2.74" (6.96cm)	1.69" (4.29cm)
16/20A 3-P, 4-W	3.125" (7.94cm)	0.21" (0.54cm)	3.125" (7.94cm)	3.28" (8.33cm)	3.75" (9.52cm)	3.75" (9.52cm)	0.315" (.8cm)	3.38" (8.58cm)	2.18" (5.54cm)	1.25" (3.18cm)	2.74" (6.96cm)	2.74" (6.96cm)	2.01" (5.12cm)
16/20A 4-P, 5-W	3.125" (7.94cm)	0.21" (0.54cm)	3.125" (7.94cm)	3.66" (9.3cm)	3.75" (9.52cm)	3.75" (9.52cm)	0.315" (.8cm)	3.66" (9.3cm)	2.27" (5.77cm)	1.25" (3.18cm)	2.74" (6.96cm)	2.74" (6.96cm)	2.09" (5.3cm)
30/32A 2-P, 3-W & 3-P, 4-W	3.125" (7.94cm)	0.21" (0.54cm)	3.125" (7.94cm)	3.97" (10cm)	3.75" (9.52cm)	3.75" (9.52cm)	0.315" (.8cm)	3.91" (9.92cm)	2.64" (6.7cm)	1.57" (4.0cm)	2.74" (6.96cm)	2.74" (6.96cm)	2.24" (5.69cm)
30/32A 4-P, 5-W	3.125" (7.94cm)	0.21" (0.54cm)	3.125" (7.94cm)	4.22" (10.7cm)	3.75" (9.52cm)	3.75" (9.52cm)	0.315" (.8cm)	4.13" (10.5cm)	2.64" (6.7cm)	1.57" (4.0cm)	2.74" (6.96cm)	2.74" (6.96cm)	2.47" (6.27cm)

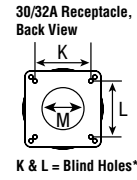
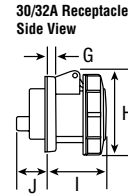
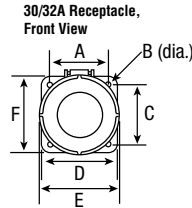
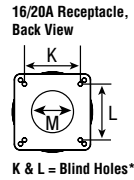
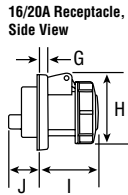
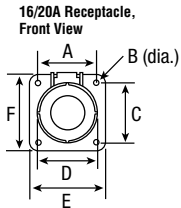

Table 2. 16/20A & 30/32A Plugs

Family	A	B	C	D (cord dia.)	Threaded Entry (NPT)
16/20A 2-P, 3-W	6.08" (15.44cm)	4.65" (11.8cm)	2.98" (7.57cm)	0.333-0.775" (0.85-1.97cm)	0.75" (1.91cm)
16/20A 3-P, 4-W	6.14" (15.6cm)	4.70" (11.94cm)	3.28" (8.33cm)	0.333-0.775" (0.85-1.97cm)	0.75" (1.91cm)
16/20A 4-P, 5-W	6.24" (15.85cm)	4.81" (12.22cm)	4.18" (10.6cm)	0.433-0.84" (1.10-2.13cm)	1.0" (2.54cm)
30/32A 2-P, 3-W & 3-P, 4-W	7.32" (18.6cm)	5.53" (14.05cm)	3.85" (9.78cm)	0.433-0.985" (1.10-2.5cm)	1.0" (2.54cm)
30/32A 4-P, 5-W	7.46" (18.95cm)	5.67" (14.4cm)	4.17" (10.6cm)	0.433-1.15" (1.10-2.92cm)	1.25" (3.18cm)

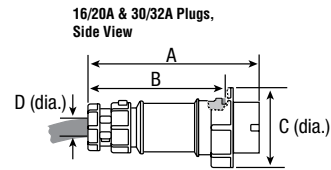

Table 3. 16/20A & 30/32A Connectors

Family	A	B	C (cord dia.)	D	Threaded Entry (NPT)
16/20A 2-P, 3-W	6.91" (17.56cm)	2.98" (7.57cm)	0.333-0.775" (0.85-1.97cm)	3.13" (7.96cm)	0.75" (1.91cm)
16/20A 3-P, 4-W	6.89" (17.49cm)	3.28" (8.33cm)	0.333-0.775" (0.85-1.97cm)	3.37" (8.56cm)	0.75" (1.91cm)
16/20A 4-P, 5-W	7.19" (18.27cm)	3.66" (8.33cm)	0.433-0.84" (1.10-2.13cm)	3.66" (9.3cm)	1.0" (2.54cm)
30/32A 2-P, 3-W & 3-P, 4-W	8.55" (22.72cm)	3.97" (10.1cm)	0.433-0.985" (1.10-2.5cm)	3.89" (9.89cm)	1.0" (2.54cm)
30/32A 4-P, 5-W	8.74" (22.19cm)	4.22" (10.7cm)	0.433-1.15" (1.10-2.92cm)	4.13" (10.49cm)	1.25" (3.18cm)

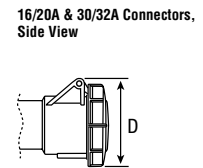
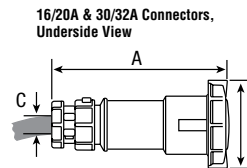
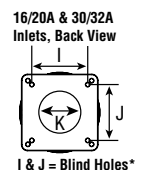
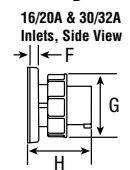
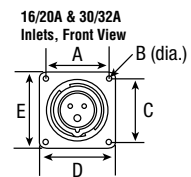

Table 4. 16/20A & 30/32A Inlets

Family	A	B	C	D	E	F	G	H	I	J	K
16/20A 2-P, 3-W	3.125" (7.94cm)	0.21" (0.54cm)	3.125" (7.94cm)	3.75" (9.52cm)	3.75" (9.52cm)	0.315" (0.8cm)	2.76" (7cm)	2.75" (6.99cm)	2.74" (6.96cm)	2.74" (6.96cm)	1.52" (3.86cm)
16/20A 3-P, 4-W	3.125" (7.94cm)	0.21" (0.54cm)	3.125" (7.94cm)	3.75" (9.52cm)	3.75" (9.52cm)	0.315" (0.8cm)	3.06" (7.77cm)	2.75" (6.99cm)	2.74" (6.96cm)	2.74" (6.96cm)	1.74" (4.42cm)
16/20A 4-P, 5-W	3.125" (7.94cm)	0.21" (0.54cm)	3.125" (7.94cm)	3.75" (9.52cm)	3.75" (9.52cm)	0.315" (0.8cm)	3.45" (8.76cm)	2.75" (6.99cm)	2.74" (6.96cm)	2.74" (6.96cm)	1.96" (4.98cm)
30/32A 2-P, 3-W & 3-P, 4-W	3.125" (7.94cm)	0.21" (0.54cm)	3.125" (7.94cm)	3.75" (9.52cm)	3.75" (9.52cm)	0.315" (0.8cm)	3.68" (9.35cm)	3.4" (8.64cm)	2.74" (6.96cm)	2.74" (6.96cm)	2.0" (5.08cm)
30/32A 4-P, 5-W	3.125" (7.94cm)	0.21" (0.54cm)	3.125" (7.94cm)	3.75" (9.52cm)	3.75" (9.52cm)	0.315" (0.8cm)	3.94" (10cm)	3.4" (8.64cm)	2.74" (6.96cm)	2.74" (6.96cm)	2.22" (5.64cm)



Dimensional information

Table 5. 60/63A & 100/125A Receptacles

Family	A	B	C	D	E	F	G	H	I	J	K	L	M	N
60/63 Amp	3.88" (9.8cm)	0.21" (0.54cm)	3.88" (9.8cm)	4.5" (11.4cm)	4.6" (11.7cm)	4.5" (11.4cm)	0.079" (0.2cm)	4.42" (11.2cm)	3.02" (7.68cm)	2.3" (5.8cm)	0.39" (1cm)	3.03" (7.70cm)	3.35" (8.51cm)	3.35" (8.5cm)
100/125 Amp	4.87" (12.4cm)	0.21" (0.54cm)	4.87" (12.4cm)	5.5" (14cm)	5.11" (13cm)	5.5" (14cm)	0.12" (0.3cm)	4.86" (12.3cm)	4.20" (10.7cm)	1.93" (4.9cm)	0.47" (1.2cm)	4.10" (10.4cm)	4.10" (10.4cm)	4.57" (11.6cm)

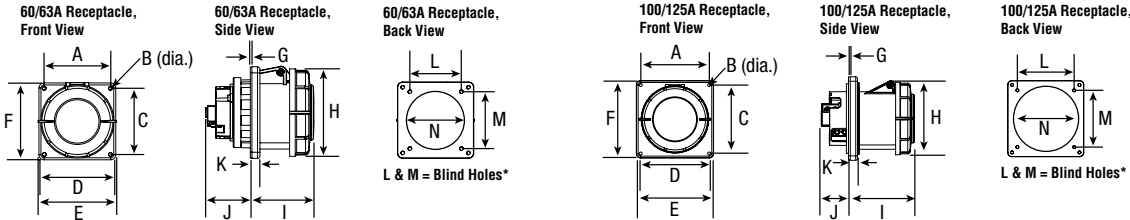

Table 6. 60A & 100A Angled Receptacles

Family	A	B	C	D	E	F	G	H	I	J
60 Amp	4.69" (119.2mm)	0.21" (5.3mm)	3.87" (98.4mm)	3.87" (98.4mm)	4.69" (119.2mm)	.45" (11.5mm)	5.49" (139.5mm)	2.26" (57.3mm)	3.35" (85.1mm)	3.03" (77mm)
100 Amp	5.5" (139.6mm)	0.21" (5.3mm)	4.87" (123.7mm)	4.87" (123.7mm)	5.5" (139.6mm)	.55" (14.0mm)	6.35" (161.3mm)	2.85" (72.4mm)	3.54" (90.0mm)	3.54" (90.0mm)

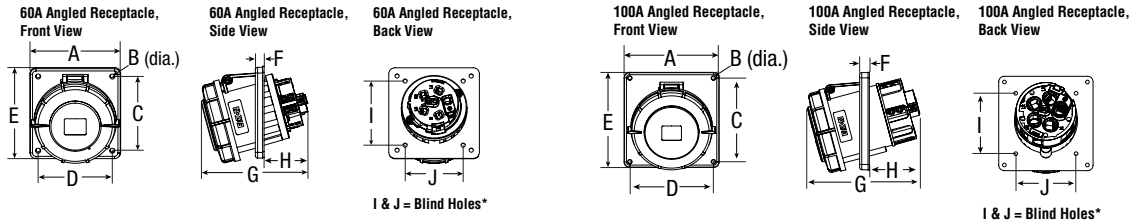

Table 7. 60/63A & 100/125A Plugs

Family	A	B	C (cord dia.)	Threaded Entry (NPT)
60/63 Amp	9.26" (23.52cm)	4.45" (11.29cm)	0.66-1.50" (1.68-3.81cm)	1.5" (3.81cm)
100/125 Amp	11.16" (28.35cm)	5.17" (13.14cm)	0.97-1.94" (2.46-5.00cm)	2.0" (5.08cm)

Table 8. 60/63A & 100/125A Connectors

Family	A	B	C (cord dia.)	D	Threaded Entry (NPT)
60/63 Amp	10" (25.39cm)	4.29" (10.9cm)	0.66-1.5" (1.68-3.81cm)	4.43" (11.25cm)	1.5" (3.81cm)
100/125 Amp	11.83" (30.04cm)	4.76" (12.1cm)	0.97-1.94" (2.46-4.93cm)	4.86" (12.34cm)	2.0" (5.08cm)

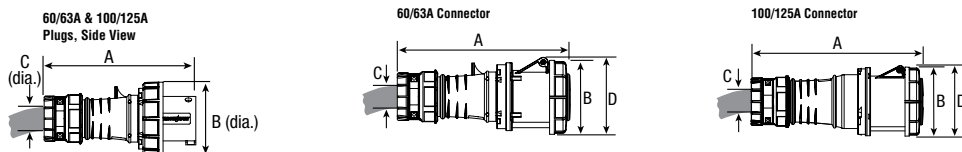
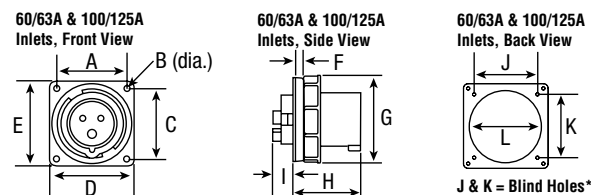

Table 9. 60/63A & 100/125A Inlets

Family	A	B	C	D	E	F	G	H	I	J	K	L	M	N
60/63 Amp	3.875" (9.84 cm)	0.21" (0.54cm)	3.88" (9.84 cm)	4.5" (11.4 cm)	4.5" (11.4 cm)	0.39" (1cm)	4.45" (11.30 cm)	3.25" (8.26cm)	1.52" (3.87 cm)	3.88" (9.84 cm)	3.88" (9.84 cm)	2.88" (7.32 cm)	3.54" (8.99 cm)	3.54" (8.99 cm)
100/125 Amp	4.87" (12.4cm)	0.21" (0.54 cm)	4.87" (12.4 cm)	5.5" (14cm)	5.5" (14cm)	0.47" (1.2 cm)	5.17" (13.1cm)	4" (10.2 cm)	1.38" (3.51 cm)	4.87" (12.4 cm)	4.87" (12.4 cm)	3.66" (9.3 cm)	4.10" (10.41 cm)	4.10" (10.41 cm)



Dimensional information

Table 10. 20/23A & 30/32A, 60/63A, 100/125A Back Boxes

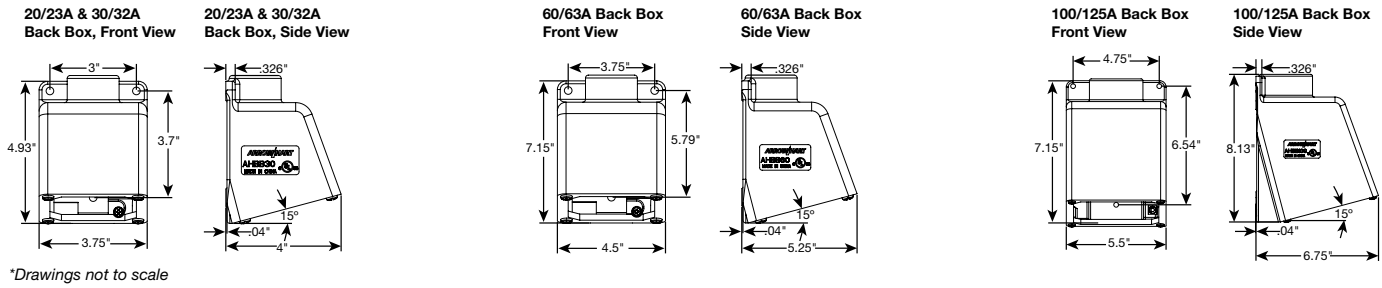
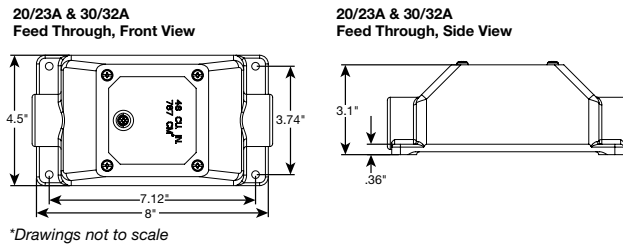
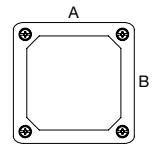

Table 11. 20/23A & 30/32A Feed Through



Mounting Holes for Back Boxes & Feed Through

Family	A	B
16/20A & 30/32A	3.125" (79.4mm)	3.125" (79.4mm)
60/63A	3.875" (98.4mm)	3.875" (98.4mm)
100/125A	4.870" (123.7mm)	4.870" (123.7mm)
Feed Through	3.125" (79.4mm)	3.125" (79.4mm)



#10-32 Tapped Holes

Table 12. 20A Non-Fusible Mechanical Interlocks

Family	A	B	C	D	E	F	G
20 Amp 2-P, 3-W	6.70" (17.02cm)	5.35" (13.59cm)	0.24" (0.61cm)	5.35" (13.59cm)	0.24" (0.61cm)	4.65" (11.81cm)	4.10" (10.41cm)
20 Amp 3-P, 4-W	6.70" (17.02cm)	5.35" (13.59cm)	0.24" (0.61cm)	5.47" (13.89cm)	0.24" (0.61cm)	4.65" (11.81cm)	4.10" (10.41cm)
20 Amp 4-P, 5-W	6.70" (17.02cm)	5.35" (13.59cm)	0.24" (0.61cm)	5.63" (14.30cm)	0.24" (0.61cm)	4.65" (11.81cm)	4.10" (10.41cm)

20A Interlock, Front View

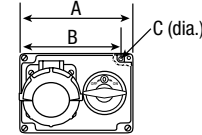

20A Interlock, Side View

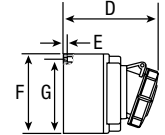
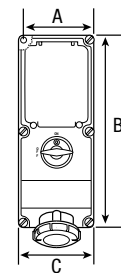

Table 13. 20A Fuse or Circuit Breaker Option Mechanical Interlocks

Family	A	B	C	D	E	F	G	H
20 Amp 3-P, 4-W	4.59" (11.66cm)	14.33" (36.40cm)	5.28" (13.41cm)	0.32" (0.81cm)	15.37" (39.04cm)	6.12" (15.54cm)	13.66" (34.70cm)	0.25" (0.64cm)

20A & 30A Interlock, Front View



20A & 30A Interlock, Side View

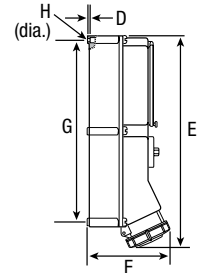

Dimensional information

Table 14. 30A Non-Fusible & Fusible Mechanical Interlocks

30A Interlock, Front View	30A Interlock, Side View	30A Interlock, Bottom View	Family	A	B	C	D	E	Hub Size
			30 Amp	6.56"	10.30"	6.69"	12.00"	6.44"	1"
			2-P, 3-W	(16.66cm)	(26.16cm)	(16.99cm)	(30.48cm)	(16.36cm)	(2.54cm)
			30 Amp	6.56"	10.30"	6.69"	12.00"	6.44"	1"
			3-P, 4-W	(16.66cm)	(26.16cm)	(16.99cm)	(30.48cm)	(16.36cm)	(2.54cm)
			30 Amp	6.56"	10.30"	6.69"	12.00"	6.44"	1"
			4-P, 5-W	(16.66cm)	(26.16cm)	(16.99cm)	(30.48cm)	(16.36cm)	(2.54cm)

Table 15. 30A Fuse or Circuit Breaker Option Mechanical Interlocks

20A & 30A Interlock, Front View	20A & 30A Interlock, Side View	Family	A	B	C	D	E	F	G	H
		30 Amp	4.59" (11.66cm)	14.33" (36.40cm)	5.28" (13.41cm)	0.32" (0.81cm)	15.37" (39.04cm)	6.12" (15.54cm)	13.66" (34.70cm)	0.25" (0.64cm)
		3-P, 4-W								
		30 Amp	4.59" (11.66cm)	14.33" (36.40cm)	5.28" (13.41cm)	0.32" (0.81cm)	15.37" (39.04cm)	6.12" (15.54cm)	13.66" (34.70cm)	0.25" (0.64cm)
		4-P, 5-W								

Table 16. 60A Non-Fusible & Fusible Mechanical Interlocks

60A Interlock, Front View	60A Interlock, Side View	60A Interlock, Bottom View	Family	A	B	C	D	E	Hub Size
			60 Amp	7.00"	13.00"	9.25"	14.62"	8.38"	1 1/4"
			2-P, 3-W	(17.78cm)	(33.02cm)	(23.50cm)	(37.13cm)	(37.13cm)	(3.18cm)
			60 Amp	7.00"	13.00"	9.25"	14.62"	8.38"	1 1/4"
			3-P, 4-W	(17.78cm)	(33.02cm)	(23.50cm)	(37.13cm)	(37.13cm)	(3.18cm)
			60 Amp	7.00"	13.00"	9.25"	14.62"	8.38"	1 1/4"
			4-P, 5-W	(17.78cm)	(33.02cm)	(23.50cm)	(37.13cm)	(37.13cm)	(3.18cm)

Table 17. 60A Fuse or Circuit Breaker Option Mechanical Interlocks

60A Interlock, Front View	60A Interlock, Side View	Family	A	B	C	D	E	F	G	H
		60 Amp	6.25" (15.88cm)	18.11" (46.00cm)	7.09" (18.01cm)	0.32" (0.81cm)	19.56" (49.68cm)	7.56" (19.20cm)	17.32" (43.99cm)	0.32" (0.81cm)
		3-P, 4-W								
		60 Amp	6.25" (15.88cm)	18.11" (46.00cm)	7.09" (18.01cm)	0.32" (0.81cm)	19.56" (49.68cm)	7.56" (19.20cm)	17.32" (43.99cm)	0.32" (0.81cm)
		4-P, 5-W								

Table 18. 100A Non-Fusible Mechanical Interlocks

100A Interlock, Front View	100A Interlock, Side View	Family	A	B	C	D	E	F	G	H
		100 Amp	10.25" (26.04cm)	18.13" (46.05cm)	9.25" (23.50cm)	17.06" (43.33cm)	0.38" (0.97cm)	20.69" (52.55cm)	11.13" (28.27cm)	0.24" (0.11cm)
		2-P, 3-W								
		100 Amp	10.25" (26.04cm)	18.13" (46.05cm)	9.25" (23.50cm)	17.06" (43.33cm)	0.38" (0.97cm)	20.69" (52.55cm)	11.13" (28.27cm)	0.24" (0.11cm)
		3-P, 4-W								
		100 Amp	10.25" (26.04cm)	18.13" (46.05cm)	9.25" (23.50cm)	17.06" (43.33cm)	0.38" (0.97cm)	20.69" (52.55cm)	11.13" (28.27cm)	0.24" (0.11cm)
		4-P, 5-W								

Horsepower rating

Pin & Sleeve HP Rating Devices

Catalog No.	Type	Voltage	HP Rating High voltage
AH420B5W	Inlet	3Ø 600V	7 1/2
AH420B7W	Inlet	3Ø 480V	5
AH420B9W	Inlet	3Ø 250V	2
AH420C5W	Connector	3Ø 600V	7 1/2
AH420C7W	Connector	3Ø 480V	5
AH420C9W	Connector	3Ø 250V	2
AH420P5W	Plug	3Ø 600V	7 1/2
AH420P7W	Plug	3Ø 480V	5
AH420P9W	Plug	3Ø 250V	2
AH420R5W	Receptacle	3Ø 600V	7 1/2
AH420R7W	Receptacle	3Ø 480V	5
AH420R9W	Receptacle	3Ø 250V	2
AH520B5W	Inlet	347/600 3ØY	7 1/2
AH520B7W	Inlet	277/480 3ØY	5
AH520B9W	Inlet	120/208 3ØY	1 1/2
AH520C5W	Connector	347/600 3ØY	7 1/2
AH520C7W	Connector	277/480 3ØY	5
AH520C9W	Connector	120/208 3ØY	
AH520P5W	Plug	347/600 3ØY	7 1/2
AH520P7W	Plug	277/480 3ØY	5
AH520P9W	Plug	120/208 3ØY	1 1/2
AH520R5W	Receptacle	347/600 3ØY	7 1/2
AH520R7W	Receptacle	277/480 3ØY	5
AH520R9W	Receptacle	120/208 3ØY	1 1/2
AH430B5W	Inlet	3Ø 600V	15
AH430B7W	Inlet	3Ø 480V	10
AH430B9W	Inlet	3Ø 250V	5
AH430C5W	Connector	3Ø 600V	15
AH430C7W	Connector	3Ø 480V	10
AH430C9W	Connector	3Ø 250V	5
AH430P5W	Plug	3Ø 600V	15
AH430P7W	Plug	3Ø 480V	10
AH430P9W	Plug	3Ø 250V	5
AH430R5W	Receptacle	3Ø 600V	15
AH430R7W	Receptacle	3Ø 480V	10
AH430R9W	Receptacle	3Ø 250V	5
AH530B5W	Inlet	347/600 3ØY	15
AH530B7W	Inlet	277/480 3ØY	10
AH530B9W	Inlet	120/208 3ØY	3
AH530C5W	Connector	347/600 3ØY	15
AH530C7W	Connector	277/480 3ØY	10
AH530C9W	Connector	120/208 3ØY	3
AH530P5W	Plug	347/600 3ØY	15
AH530P7W	Plug	277/480 3ØY	10
AH530P9W	Plug	120/208 3ØY	3
AH530R5W	Receptacle	347/600 3ØY	15
AH530R7W	Receptacle	277/480 3ØY	10
AH530R9W	Receptacle	120/208 3ØY	3

Pin & Sleeve HP Rating Devices

Catalog No.	Type	Voltage	HP Rating High voltage
AH460B5W	Inlet	3Ø 600V	20
AH460B7W	Inlet	3Ø 480V	15
AH460B9W	Inlet	3Ø 250V	7 1/2
AH460C5W	Connector	3Ø 600V	20
AH460C7W	Connector	3Ø 480V	15
AH460C9W	Connector	3Ø 250V	7 1/2
AH460P5W	Plug	3Ø 600V	20
AH460P7W	Plug	3Ø 480V	15
AH460P9W	Plug	3Ø 250V	7 1/2
AH460R5W	Receptacle	3Ø 600V	20
AH460R7W	Receptacle	3Ø 480V	15
AH460R9W	Receptacle	3Ø 250V	7 1/2
AH560B5W	Inlet	347/600 3ØY	20
AH560B7W	Inlet	277/480 3ØY	15
AH560B9W	Inlet	120/208 3ØY	5
AH560C5W	Connector	347/600 3ØY	20
AH560C7W	Connector	277/480 3ØY	15
AH560C9W	Connector	120/208 3ØY	5
AH560P5W	Plug	347/600 3ØY	20
AH560P7W	Plug	277/480 3ØY	15
AH560P9W	Plug	120/208 3ØY	5
AH560R5W	Receptacle	347/600 3ØY	20
AH560R7W	Receptacle	277/480 3ØY	15
AH560R9W	Receptacle	120/208 3ØY	5
AH4100B5W	Inlet	3Ø 600V	30
AH4100B7W	Inlet	3Ø 480V	20
AH4100B9W	Inlet	3Ø 250V	10
AH4100C5W	Connector	3Ø 600V	30
AH4100C7W	Connector	3Ø 480V	20
AH4100C9W	Connector	3Ø 250V	10
AH4100P5W	Plug	3Ø 600V	30
AH4100P7W	Plug	3Ø 480V	20
AH4100P9W	Plug	3Ø 250V	10
AH4100R5W	Receptacle	3Ø 600V	30
AH4100R7W	Receptacle	3Ø 480V	20
AH4100R9W	Receptacle	3Ø 250V	10
AH5100B5W	Inlet	347/600 3ØY	30
AH5100B7W	Inlet	277/480 3ØY	20
AH5100B9W	Inlet	120/208 3ØY	7 1/2
AH5100C5W	Connector	347/600 3ØY	30
AH5100C7W	Connector	277/480 3ØY	20
AH5100C9W	Connector	120/208 3ØY	7 1/2
AH5100P5W	Plug	347/600 3ØY	30
AH5100P7W	Plug	277/480 3ØY	20
AH5100P9W	Plug	120/208 3ØY	7 1/2
AH5100R5W	Receptacle	347/600 3ØY	30
AH5100R7W	Receptacle	277/480 3ØY	20
AH5100R9W	Receptacle	120/208 3ØY	7 1/2

Specifications for IEC 309 watertight pin & sleeve devices

Product Description

North American 20A & 30A; 2-pole, 3-wire grounding; 3-pole, 4-wire grounding; 4-pole, 5-wire grounding

Device Type	20A & 30A Pin & Sleeve Receptacles	20A & 30A Pin & Sleeve Plugs	20A & 30A Pin & Sleeve Connectors	20A & 30A Pin & Sleeve Inlets
Testing & Code Compliance:	Base Device: <ul style="list-style-type: none"> Classified to IEC Standards 60309-1 and 60309-2 cULus Listed to UL1682, UL1686 and CSA C22.2 No. 182.1 	Base Device: <ul style="list-style-type: none"> Classified to IEC Standards 60309-1 and 60309-2 cULus Listed to UL1682, UL1686 and CSA C22.2 No. 182.1 	Base Device: <ul style="list-style-type: none"> Classified to IEC Standards 60309-1 and 60309-2 cULus Listed to UL1682, UL1686 CSA and C22.2 No. 182.1 	Base Device: <ul style="list-style-type: none"> Classified to IEC Standards 60309-1 and 60309-2 cULus Listed to UL1682, UL1686 and CSA C22.2 No. 182.1
Specifications Environmental:	Flammability: Meets UL94 requirements; HB rated (housing), V0 rated (contact carriers) Protection: Watertight to IP67 per IEC 60529 & IP69K to DIN 40050 Part 9	Flammability: Meets UL94 requirements; HB rated (housing), V0 rated (contact carriers) Protection: Watertight to IP67 per IEC 60529 & IP69K to DIN 40050 Part 9	Flammability: Meets UL94 requirements; HB rated (housing), V0 rated (contact carriers) Protection: Watertight to IP67 per IEC 60529 & IP69K to DIN 40050 Part 9	Flammability: Meets UL94 requirements; HB rated (housing), V0 rated (contact carriers) Protection: Watertight to IP67 per IEC 60529 & IP69K to DIN 40050 Part 9
Specifications Electrical:	Dielectric voltage: 3000V Maximum Working Voltage: 600V (rms) Current Interrupting: Yes, at full-rated current & voltage Temperature Rise: Max. 30°C (86°F) after 50 cycles of overload @150% of rated current Endurance: 5000 cycles	Dielectric voltage: 3000V Maximum Working Voltage: 600V (rms) Current Interrupting: Yes, at full-rated current & voltage Temperature Rise: Max. 30°C (86°F) after 50 cycles of overload @150% of rated current Endurance: 5000 cycles	Dielectric voltage: 3000V Maximum Working Voltage: 600V (rms) Current Interrupting: Yes, at full-rated current & voltage Temperature Rise: Max. 30°C (86°F) after 50 cycles of overload @150% of rated current Endurance: 5000 cycles	Dielectric voltage: 3000V Maximum Working Voltage: 600V (rms) Current Interrupting: Yes, at full-rated current & voltage Temperature Rise: Max. 30°C (86°F) after 50 cycles of overload @150% of rated current Endurance: 5000 cycles
Specifications Mechanical:	Voltage Ratings: Marked on device Impact Resistance: UL1682 Cable Grip Retention: UL1682	Voltage Ratings: Marked on device Impact Resistance: UL1682 Cable Grip Retention: UL1682	Voltage Ratings: Marked on device Impact Resistance: UL1682 Cable Grip Retention: UL1682	Voltage Ratings: Marked on device Impact Resistance: UL1682 Cable Grip Retention: UL1682
Materials:	Housing & Flange: Nylon PA6-GF30 Back Body: N/A Contact Carrier: Nylon PA6 Sleeves: Nickel plated Brass Contact Spring on Sleeves: Nickel plated spring steel Pins: N/A External Strain Relief Clamp: N/A Cable Seal: N/A Support Washer for Cord Grip: N/A Cover: Nylon PA6-GF30 Hinge Pin: Nylon PA6-GF30 Cover Spring: Stainless steel Cover Gasket: Silicon rubber Flange Gasket: Silicon rubber Terminal Screws: Nickel plated steel Assembly Screws: Stainless steel	Housing & Flange: Nylon PA6-GF30 Back Body: Nylon PA6-GF30 Contact Carrier: Nylon PA6 Sleeves: N/A Contact Spring on Sleeves: N/A Pins: Nickel plated brass External Strain Relief Clamp: Nylon PA6-GF30 Cable Seal: Silicon rubber Support Washer for Cord Grip: Plated Steel Cover: N/A Hinge Pin: N/A Cover Spring: N/A Cover Gasket: Silicon rubber Flange Gasket: Silicon rubber Terminal Screws: Nickel plated steel Assembly Screws: Stainless steel	Housing & Flange: Nylon PA6-GF30 Back Body: Nylon PA6-GF30 Contact Carrier: Nylon PA6 Sleeves: Nickel plated Brass Contact Spring on Sleeves: Nickel plated spring steel Pins: N/A External Strain Relief Clamp: Nylon PA6-GF30 Cable Seal: Silicon rubber Support Washer for Cord Grip: Plated Steel Cover: Nylon PA6-GF30 Hinge Pin: Nylon PA6-GF30 Cover Spring: Stainless steel Cover Gasket: Silicon rubber Flange Gasket: Silicon rubber Terminal Screws: Nickel plated steel Assembly Screws: Stainless steel	Housing & Flange: Nylon PA6 Back Body: N/A Contact Carrier/Support Isolators: N/A Sleeves: N/A Contact Spring on Sleeves: N/A Pins: Nickel plated brass External Strain Relief Clamp: N/A Cable Seal: N/A Support Washer for Cord Grip: N/A Cover: N/A Hinge Pin: N/A Cover Spring: N/A Cover Gasket: Silicon rubber Flange Gasket: Silicon rubber Terminal Screws: Nickel plated steel Assembly Screws: Stainless steel

Specifications for IEC 309 watertight pin & sleeve devices

Product Description

North American 60A; 2-pole, 3-wire grounding; 3-pole, 4-wire grounding; 4-pole, 5-wire grounding

Device Type	60A Pin & Sleeve Receptacles	60A Pin & Sleeve Plugs	60A Pin & Sleeve Connectors	60A Pin & Sleeve Inlets
Testing & Code Compliance:	Base Device: <ul style="list-style-type: none"> Classified to IEC Standards 60309-1 and 60309-2 cULus Listed to UL1682, UL1686 and CSA C22.2 No. 182.1 	Base Device: <ul style="list-style-type: none"> Classified to IEC Standards 60309-1 and 60309-2 cULus Listed to UL1682, UL1686 and CSA C22.2 No. 182.1 	Base Device: <ul style="list-style-type: none"> Classified to IEC Standards 60309-1 and 60309-2 cULus Listed to UL1682, UL1686 and CSA C22.2 No. 182.1 	Base Device: <ul style="list-style-type: none"> Classified to IEC Standards 60309-1 and 60309-2 cULus Listed to UL1682, UL1686 and CSA C22.2 No. 182.1
Specifications Environmental:	Flammability: Meets UL94 requirements; HB rated (housing), VO rated (contact carriers) Protection: Watertight to IP67 per IEC 60529 & IP69K to DIN 40050 Part 9	Flammability: Meets UL94 requirements; HB rated (housing), VO rated (contact carriers) Protection: Watertight to IP67 per IEC 60529 & IP69K to DIN 40050 Part 9	Flammability: Meets UL94 requirements; HB rated (housing), VO rated (contact carriers) Protection: Watertight to IP67 per IEC 60529 & IP69K to DIN 40050 Part 9	Flammability: Meets UL94 requirements; HB rated (housing), VO rated (contact carriers) Protection: Watertight to IP67 per IEC 60529 & IP69K to DIN 40050 Part 9
Specifications Electrical:	Dielectric Voltage: 3000V Maximum Working Voltage: 600V (rms) Current Interrupting: Yes, at full-rated current & voltage Temperature Rise: Max. 30°C (86°F) after 50 cycles of overload @150% of rated current Endurance: 2000 cycles	Dielectric Voltage: 3000V Maximum Working Voltage: 600V (rms) Current Interrupting: Yes, at full-rated current & voltage Temperature Rise: Max. 30°C (86°F) after 50 cycles of overload @150% of rated current Endurance: 2000 cycles	Dielectric Voltage: 3000V Maximum Working Voltage: 600V (rms) Current Interrupting: Yes, at full-rated current & voltage Temperature Rise: Max. 30°C (86°F) after 50 cycles of overload @150% of rated current Endurance: 2000 cycles	Dielectric Voltage: 3000V Maximum Working Voltage: 600V (rms) Current Interrupting: Yes, at full-rated current & voltage Temperature Rise: Max. 30°C (86°F) after 50 cycles of overload @150% of rated current Endurance: 2000 cycles
Specifications Mechanical:	Voltage Ratings: Marked on device Impact Resistance: UL1682 Cable Grip Retention: UL1682	Voltage Ratings: Marked on device Impact Resistance: UL1682 Cable Grip Retention: UL1682	Voltage Ratings: Marked on device Impact Resistance: UL1682 Cable Grip Retention: UL1682	Voltage Ratings: Marked on device Impact Resistance: UL1682 Cable Grip Retention: UL1682
Materials:	Housing & Flange: Nylon PA6 Back Body: N/A Contact Carrier: Nylon PA6 Sleeves: Nickel plated brass Contact Spring on Sleeves: Nickel plated spring steel Pins: N/A External Strain Relief Clamp: N/A Cable Seal: N/A Support Washer for Cord Grip: N/A Cover: N/A Hinge Pin: Nylon PA6-GF30 Cover Spring: Nickel plated spring steel Cover Gasket: Silicon rubber Flange Gasket: Silicon rubber Terminal Screws: Nickel plated steel Assembly Screws: Stainless steel	Housing & Flange: Nylon PA6 Back Body: Nylon PA6-GF30 Contact Carrier: Nylon PA6 Sleeves: N/A Contact Spring on Sleeves: N/A Pins: Nickel plated brass External Strain Relief Clamp: Nylon PA6-GF30 Cable Seal: Silicon rubber Support Washer for Cord Grip: Plated Steel Cover: Nylon PA6-GF30 Hinge Pin: N/A Cover Spring: N/A Cover Gasket: N/A Flange Gasket: N/A Terminal Screws: Nickel plated steel Assembly Screws: Stainless steel	Housing & Flange: Nylon PA6 Back Body: Nylon PA6-GF30 Contact Carrier: Nylon PA6 Sleeves: Nickel plated brass Contact Spring on Sleeves: Nickel plated spring steel Pins: N/A External Strain Relief Clamp: Nylon PA6-GF30 Cable Seal: Silicon rubber Support Washer for Cord Grip: Plated Steel Cover: N/A Hinge Pin: Nylon PA6-GF30 Cover Spring: Nickel plated spring steel Cover Gasket: Silicon rubber Flange Gasket: N/A Terminal Screws: Nickel plated steel Assembly Screws: Stainless steel	Housing & Flange: Nylon PA6 Back Body: N/A Contact Carrier: Nylon PA6 Sleeves: N/A Contact Spring on Sleeves: N/A Pins: Nickel plated brass External Strain Relief Clamp: N/A Cable Seal: N/A Support Washer for Cord Grip: N/A Cover: Nylon PA6-GF30 Hinge Pin: N/A Cover Spring: N/A Cover Gasket: N/A Flange Gasket: Silicon rubber Terminal Screws: Nickel plated steel Assembly Screws: Stainless steel

Specifications for IEC 309 watertight pin & sleeve devices

Product Description

North American 100A; 2-pole, 3-wire grounding; 3-pole, 4-wire grounding; 4-pole, 5-wire grounding

Device Type	100A Pin & Sleeve Receptacles	100A Pin & Sleeve Plugs	100A Pin & Sleeve Connectors	100A Pin & Sleeve Inlets
Testing & Code Compliance:	Base Device: <ul style="list-style-type: none"> Classified to IEC Standards 60309-1 and 60309-2 cULus Listed to UL1682, UL1686 and CSA C22.2 No. 182.1 	Base Device: <ul style="list-style-type: none"> Classified to IEC Standards 60309-1 and 60309-2 cULus Listed to UL1682, UL1686 and CSA C22.2 No. 182.1 	Base Device: <ul style="list-style-type: none"> Classified to IEC Standards 60309-1 and 60309-2 cULus Listed to UL1682, UL1686 and CSA C22.2 No. 182.1 	Base Device: <ul style="list-style-type: none"> Classified to IEC Standards 60309-1 and 60309-2 cULus Listed to UL1682, UL1686 and CSA C22.2 No. 182.1
Specifications Environmental:	Flammability: Meets UL94 requirements; HB rated (housing), V0 rated (contact carriers) Protection: Watertight to IP67 per IEC 60529 & IP69K to DIN 40050 Part 9	Flammability: Meets UL94 requirements; HB rated (housing), V0 rated (contact carriers) Protection: Watertight to IP67 per IEC 60529 & IP69K to DIN 40050 Part 9	Flammability: Meets UL94 requirements; HB rated (housing), V0 rated (contact carriers) Protection: Watertight to IP67 per IEC 60529 & IP69K to DIN 40050 Part 9	Flammability: Meets UL94 requirements; HB rated (housing), V0 rated (contact carriers) Protection: Watertight to IP67 per IEC 60529 & IP69K to DIN 40050 Part 9
Specifications Electrical:	Dielectric Voltage: 3000V Maximum Working Voltage: 600V (rms) Current Interrupting: Yes, at full-rated current & voltage Temperature Rise: Max. 30°C (86°F) after 50 cycles of overload @150% of rated current Endurance: 500 cycles	Dielectric Voltage: 3000V Maximum Working Voltage: 600V (rms) Current Interrupting: Yes, at full-rated current & voltage Temperature Rise: Max. 30°C (86°F) after 50 cycles of overload @150% of rated current Endurance: 500 cycles	Dielectric Voltage: 3000V Maximum Working Voltage: 600V (rms) Current Interrupting: Yes, at full-rated current & voltage Temperature Rise: Max. 30°C (86°F) after 50 cycles of overload @150% of rated current Endurance: 500 cycles	Dielectric Voltage: 3000V Maximum Working Voltage: 600V (rms) Current Interrupting: Yes, at full-rated current & voltage Temperature Rise: Max. 30°C (86°F) after 50 cycles of overload @150% of rated current Endurance: 500 cycles
Specifications Mechanical:	Voltage Ratings: Marked on device Impact Resistance: UL1682 Cable Grip Retention: UL1682	Voltage Ratings: Marked on device Impact Resistance: UL1682 Cable Grip Retention: UL1682	Voltage Ratings: Marked on device Impact Resistance: UL1682 Cable Grip Retention: UL1682	Voltage Ratings: Marked on device Impact Resistance: UL1682 Cable Grip Retention: UL1682
Materials:	Housing & Flange: Nylon PA66 Back Body: N/A Contact Carrier: Nylon PA6 Sleeves: Nickel plated brass Contact Spring on Sleeves: Nickel plated spring steel Pins: N/A External Strain Relief Clamp: N/A Cable Seal: N/A Support Washer for Cord Grip: N/A Cover: Nylon PA6-GF30 Hinge Pin: Nylon PA6-GF30 Cover Spring: Nickel plated spring steel Cover Gasket: Silicon rubber Flange Gasket: Silicon rubber Terminal Screws: Nickel plated steel Assembly Screws: Stainless steel	Housing & Flange: Nylon PA66 Back Body: Nylon PA6-GF30 Contact Carrier: Nylon PA6 Sleeves: N/A Contact Spring on Sleeves: N/A Pins: Nickel plated brass External Strain Relief Clamp: Nylon PA6-GF30 Cable Seal: Silicon rubber Support Washer for Cord Grip: Plated Steel Cover: N/A Hinge Pin: N/A Cover Spring: N/A Cover Gasket: N/A Flange Gasket: N/A Terminal Screws: Nickel plated steel Assembly Screws: Stainless steel	Housing & Flange: Nylon PA66 Back Body: Nylon PA6-GF30 Contact Carrier: Nylon PA6 Sleeves: Nickel plated brass Contact Spring on Sleeves: Nickel plated spring steel Pins: N/A External Strain Relief Clamp: Nylon PA6-GF30 Cable Seal: Silicon rubber Support Washer for Cord Grip: Plated Steel Cover: Nylon PA6-GF30 Hinge Pin: Nylon PA6-GF30 Cover Spring: Nickel plated spring steel Cover Gasket: Silicon rubber Flange Gasket: N/A Terminal Screws: Nickel plated steel Assembly Screws: Stainless steel	Housing & Flange: Nylon PA66 Back Body: N/A Contact Carrier: Nylon PA6 Sleeves: N/A Contact Spring on Sleeves: N/A Pins: Nickel plated brass External Strain Relief Clamp: N/A Cable Seal: N/A Support Washer for Cord Grip: N/A Cover: N/A Hinge Pin: N/A Cover Spring: N/A Cover Gasket: N/A Flange Gasket: Silicon rubber Terminal Screws: Nickel plated steel Assembly Screws: Stainless steel

Specifications for IEC 309 watertight pin & sleeve devices

Product Description

International 16A & 32A; 2-pole, 3-wire grounding; 3-pole, 4-wire grounding; 4-pole, 5-wire grounding

Device Type	16A & 32A Pin & Sleeve Receptacles	16A & 32A Pin & Sleeve Plugs	16A & 32A Pin & Sleeve Connectors	16A & 32A Pin & Sleeve Inlets
Testing & Code Compliance:	Base Device: • Classified to IEC Standards 60309-1 and 60309-2	Base Device: • Classified to IEC Standards 60309-1 and 60309-2	Base Device: • Classified to IEC Standards 60309-1 and 60309-2	Base Device: • Classified to IEC Standards 60309-1 and 60309-2
Specifications Environmental:	Flammability: Meets UL94 requirements; HB rated (housing), V0 rated (contact carriers) Protection: Watertight to IP67 per IEC 60529 & IP69K to DIN 40050 Part 9	Flammability: Meets UL94 requirements; HB rated (housing), V0 rated (contact carriers) Protection: Watertight to IP67 per IEC 60529 & IP69K to DIN 40050 Part 9	Flammability: Meets UL94 requirements; HB rated (housing), V0 rated (contact carriers) Protection: Watertight to IP67 per IEC 60529 & IP69K to DIN 40050 Part 9	Flammability: Meets UL94 requirements; HB rated (housing), V0 rated (contact carriers) Protection: Watertight to IP67 per IEC 60529 & IP69K to DIN 40050 Part 9
Specifications Electrical:	Dielectric Voltage: 50-415V: 2000V, 415-500V: 2500V Maximum Working Voltage: 480V Breaking Capacity: Tested at 110% rated voltage & 125% rated current Temperature Rise: 50°C Max. Normal Operation: 5000 cycles	Dielectric Voltage: 50-415V: 2000V, 415-500V: 2500V Maximum Working Voltage: 480V Breaking Capacity: Tested at 110% rated voltage & 125% rated current Temperature Rise: 50°C Max. Normal Operation: 5000 cycles	Dielectric Voltage: 50-415V: 2000V, 415-500V: 2500V Maximum Working Voltage: 480V Breaking Capacity: Tested at 110% rated voltage & 125% rated current Temperature Rise: 50°C Max. Normal Operation: 5000 cycles	Dielectric Voltage: 50-415V: 2000V, 415-500V: 2500V Maximum Working Voltage: 480V Breaking Capacity: Tested at 110% rated voltage & 125% rated current Temperature Rise: 50°C Max. Normal Operation: 5000 cycles
Specifications Mechanical:	Voltage Ratings: Marked on device Impact Resistance: IEC60309-1 Cable Grip Retention: IEC60309-2	Voltage Ratings: Marked on device Impact Resistance: IEC60309-1 Cable Grip Retention: IEC60309-2	Voltage Ratings: Marked on device Impact Resistance: IEC60309-1 Cable Grip Retention: IEC60309-2	Voltage Ratings: Marked on device Impact Resistance: IEC60309-1 Cable Grip Retention: IEC60309-2
Materials:	Housing & Flange: Nylon PA6-GF30 Back Body: N/A Contact Carrier: Nylon PA6 Sleeves: Nickel plated brass Contact Spring on Sleeves: Nickel plated spring steel Pins: N/A External Strain Relief Clamp: N/A Cable Seal: N/A Support Washer for Cord Grip: N/A Cover: Nylon PA6-GF30 Hinge Pin: Nylon PA6-GF30 Cover Spring: Stainless steel Cover Gasket: Silicon rubber Flange Gasket: Silicon rubber Terminal Screws: Nickel plated steel Assembly Screws: Stainless steel	Housing & Flange: Nylon PA6-GF30 Back Body: Nylon PA6-GF30 Contact Carrier: Nylon PA6 Sleeves: N/A Contact Spring on Sleeves: N/A Pins: Nickel plated brass External Strain Relief Clamp: Nylon PA6-GF30 Cable Seal: Silicon rubber Support Washer for Cord Grip: Plated Steel Cover: N/A Hinge Pin: N/A Cover Spring: N/A Cover Gasket: Silicon rubber Flange Gasket: Silicon rubber Terminal Screws: Nickel plated steel Assembly Screws: Stainless steel	Housing & Flange: Nylon PA6-GF30 Back Body: Nylon PA6-GF30 Contact Carrier: Nylon PA6 Sleeves: Nickel plated brass Contact Spring on Sleeves: Nickel plated spring steel Pins: N/A External Strain Relief Clamp: Nylon PA6-GF30 Cable Seal: Silicon rubber Support Washer for Cord Grip: Plated Steel Cover: Nylon PA6-GF30 Hinge Pin: Nylon PA6-GF30 Cover Spring: Stainless steel Cover Gasket: Silicon rubber Flange Gasket: Silicon rubber Terminal Screws: Nickel plated steel Assembly Screws: Stainless steel	Housing & Flange: Nylon PA6 Back Body: N/A Contact Carrier: N/A Sleeves: N/A Contact Spring on Sleeves: N/A Pins: Nickel plated brass External Strain Relief Clamp: N/A Cable Seal: N/A Support Washer for Cord Grip: N/A Cover: N/A Hinge Pin: N/A Cover Spring: N/A Cover Gasket: Silicon rubber Flange Gasket: Silicon rubber Terminal Screws: Nickel plated steel Assembly Screws: Stainless steel

Specifications for IEC 309 watertight pin & sleeve devices

Product Description

International 63A; 2-pole, 3-wire grounding; 3-pole, 4-wire grounding; 4-pole, 5-wire grounding

Device Type	63A Pin & Sleeve Receptacles	63A Pin & Sleeve Plugs	63A Pin & Sleeve Connectors	63A Pin & Sleeve Inlets
Testing & Code Compliance:	Base Device: • Classified to IEC Standards 60309-1 and 60309-2	Base Device: • Classified to IEC Standards 60309-1 and 60309-2	Base Device: • Classified to IEC Standards 60309-1 and 60309-2	Base Device: • Classified to IEC Standards 60309-1 and 60309-2
Specifications Environmental:	Flammability: Meets UL94 requirements; HB rated (housing),VO rated (contact carriers) Protection: Watertight to IP67 per IEC 60529 & IP69K to DIN 40050 Part 9	Flammability: Meets UL94 requirements; HB rated (housing),VO rated (contact carriers) Protection: Watertight to IP67 per IEC 60529 & IP69K to DIN 40050 Part 9	Flammability: Meets UL94 requirements; HB rated (housing),VO rated (contact carriers) Protection: Watertight to IP67 per IEC 60529 & IP69K to DIN 40050 Part 9	Flammability: Meets UL94 requirements; HB rated (housing),VO rated (contact carriers) Protection: Watertight to IP67 per IEC 60529 & IP69K to DIN 40050 Part 9
Specifications Electrical:	Dielectric Voltage: 50-415V: 2000V, 415-500V: 2500V Maximum Working Voltage: 480V Breaking Capacity: Tested at 110% rated voltage & 125% rated current Temperature Rise: 50°C Max. Normal Operation: 2000 cycles	Dielectric Voltage: 50-415V: 2000V, 415-500V: 2500V Maximum Working Voltage: 480V Breaking Capacity: Tested at 110% rated voltage & 125% rated current Temperature Rise: 50°C Max. Normal Operation: 2000 cycles	Dielectric Voltage: 50-415V: 2000V, 415-500V: 2500V Maximum Working Voltage: 480V Breaking Capacity: Tested at 110% rated voltage & 125% rated current Temperature Rise: 50°C Max. Normal Operation: 2000 cycles	Dielectric Voltage: 50-415V: 2000V, 415-500V: 2500V Maximum Working Voltage: 480V Breaking Capacity: Tested at 110% rated voltage & 125% rated current Temperature Rise: 50°C Max. Normal Operation: 2000 cycles
Specifications Mechanical:	Voltage Ratings: Marked on device Impact Resistance: IEC60309-1 Cable Grip Retention: IEC60309-2	Voltage Ratings: Marked on device Impact Resistance: IEC60309-1 Cable Grip Retention: IEC60309-2	Voltage Ratings: Marked on device Impact Resistance: IEC60309-1 Cable Grip Retention: IEC60309-2	Voltage Ratings: Marked on device Impact Resistance: IEC60309-1 Cable Grip Retention: IEC60309-2
Materials:	Housing & Flange: Nylon PA6 Back Body: N/A Contact Carrier: Nylon PA6 Sleeves: Nickel plated brass Contact Spring on Sleeves: Nickel plated spring steel Pins: N/A External Strain Relief Clamp: N/A Cable Seal: N/A Support Washer for Cord Grip: N/A Cover: N/A Hinge Pin: Nylon PA6-GF30 Cover Spring: Nickel plated spring steel Cover Gasket: Silicon rubber Flange Gasket: Silicon rubber Terminal Screws: Nickel plated steel Assembly Screws: Stainless steel	Housing & Flange: Nylon PA6 Back Body: Nylon PA6-GF30 Contact Carrier: Nylon PA6 Sleeves: N/A Contact Spring on Sleeves: N/A Pins: Nickel plated brass External Strain Relief Clamp: Nylon PA6-GF30 Cable Seal: Silicon rubber Support Washer for Cord Grip: Plated Steel Cover: Nylon PA6-GF30 Hinge Pin: N/A Cover Spring: N/A Cover Gasket: N/A Flange Gasket: N/A Terminal Screws: Nickel plated steel Assembly Screws: Stainless steel	Housing & Flange: Nylon PA6 Back Body: Nylon PA6-GF30 Contact Carrier: Nylon PA6 Sleeves: Nickel plated brass Contact Spring on Sleeves: Nickel plated spring steel Pins: N/A External Strain Relief Clamp: Nylon PA6-GF30 Cable Seal: Silicon rubber Support Washer for Cord Grip: Plated Steel Cover: N/A Hinge Pin: Nylon PA6-GF30 Cover Spring: Nickel plated spring steel Cover Gasket: Silicon rubber Flange Gasket: N/A Terminal Screws: Nickel plated steel Assembly Screws: Stainless steel	Housing & Flange: Nylon PA6 Back Body: N/A Contact Carrier: Nylon PA6 Sleeves: N/A Contact Spring on Sleeves: N/A Pins: Nickel plated brass External Strain Relief Clamp: N/A Cable Seal: N/A Support Washer for Cord Grip: N/A Cover: Nylon PA6-GF30 Hinge Pin: N/A Cover Spring: N/A Cover Gasket: N/A Flange Gasket: Silicon rubber Terminal Screws: Nickel plated steel Assembly Screws: Stainless steel

Specifications for IEC 309 watertight pin & sleeve devices

Product Description

International 125A; 2-pole, 3-wire grounding; 3-pole, 4-wire grounding; 4-pole, 5-wire grounding

Device Type	125A Pin & Sleeve Receptacles	125A Pin & Sleeve Plugs	125A Pin & Sleeve Connectors	125A Pin & Sleeve Inlets
Testing & Code Compliance:	Base Device: • Classified to IEC Standards 60309-1 and 60309-2	Base Device: • Classified to IEC Standards 60309-1 and 60309-2	Base Device: • Classified to IEC Standards 60309-1 and 60309-2	Base Device: • Classified to IEC Standards 60309-1 and 60309-2
Specifications Environmental:	Flammability: Meets UL94 requirements; HB rated (housing), V0 rated (contact carriers) Protection: Watertight to IP67 per IEC 60529 & IP69K to DIN 40050 Part 9	Flammability: Meets UL94 requirements; HB rated (housing), V0 rated (contact carriers) Protection: Watertight to IP67 per IEC 60529 & IP69K to DIN 40050 Part 9	Flammability: Meets UL94 requirements; HB rated (housing), V0 rated (contact carriers) Protection: Watertight to IP67 per IEC 60529 & IP69K to DIN 40050 Part 9	Flammability: Meets UL94 requirements; HB rated (housing), V0 rated (contact carriers) Protection: Watertight to IP67 per IEC 60529 & IP69K to DIN 40050 Part 9
Specifications Electrical:	Dielectric Voltage: 50-415V: 2000V, 415-500V: 2500V Maximum Working Voltage: 480V Breaking Capacity: Tested at 110% rated voltage & 125% rated current Temperature Rise: 50°C Max. Normal Operation: 500 cycles	Dielectric Voltage: 50-415V: 2000V, 415-500V: 2500V Maximum Working Voltage: 480V Breaking Capacity: Tested at 110% rated voltage & 125% rated current Temperature Rise: 50°C Max. Normal Operation: 500 cycles	Dielectric Voltage: 50-415V: 2000V, 415-500V: 2500V Maximum Working Voltage: 480V Breaking Capacity: Tested at 110% rated voltage & 125% rated current Temperature Rise: 50°C Max. Normal Operation: 500 cycles	Dielectric Voltage: 50-415V: 2000V, 415-500V: 2500V Maximum Working Voltage: 480V Breaking Capacity: Tested at 110% rated voltage & 125% rated current Temperature Rise: 50°C Max. Normal Operation: 500 cycles
Specifications Mechanical:	Voltage Ratings: Marked on device Impact Resistance: IEC60309-1 Cable Grip Retention: IEC60309-2	Voltage Ratings: Marked on device Impact Resistance: IEC60309-1 Cable Grip Retention: IEC60309-2	Voltage Ratings: Marked on device Impact Resistance: IEC60309-1 Cable Grip Retention: IEC60309-2	Voltage Ratings: Marked on device Impact Resistance: IEC60309-1 Cable Grip Retention: IEC60309-2
Materials:	Housing & Flange: Nylon PA66 Back Body: N/A Contact Carrier: Nylon PA6-GF30 Sleeves: Nickel plated brass Contact Spring on Sleeves: Nickel plated spring steel Pins: N/A External Strain Relief Clamp: N/A Cable Seal: N/A Support Washer for Cord Grip: N/A Cover: Nylon PA6-GF30 Hinge Pin: Nylon PA6-GF30 Cover Spring: Nickel plated spring steel Cover Gasket: Silicon rubber Flange Gasket: Silicon rubber Terminal Screws: Nickel plated steel Assembly Screws: Stainless steel	Housing & Flange: Nylon PA66 Back Body: Nylon PA6-GF30 Contact Carrier: Nylon PA6-GF30 Sleeves: N/A Contact Spring on Sleeves: N/A Pins: Nickel plated brass External Strain Relief Clamp: Nylon PA6-GF30 Cable Seal: Silicon rubber Support Washer for Cord Grip: Plated Steel Cover: N/A Hinge Pin: N/A Cover Spring: N/A Cover Gasket: N/A Flange Gasket: N/A Terminal Screws: Nickel plated steel Assembly Screws: Stainless steel	Housing & Flange: Nylon PA66 Back Body: Nylon PA6-GF30 Contact Carrier: Nylon PA6-GF30 Sleeves: Nickel plated brass Contact Spring on Sleeves: Nickel plated spring steel Pins: N/A External Strain Relief Clamp: Nylon PA6-GF30 Cable Seal: Silicon rubber Support Washer for Cord Grip: Plated Steel Cover: Nylon PA6-GF30 Hinge Pin: Nylon PA6-GF30 Cover Spring: Nickel plated spring steel Cover Gasket: Silicon rubber Flange Gasket: N/A Terminal Screws: Nickel plated steel Assembly Screws: Stainless steel	Housing & Flange: Nylon PA66 Back Body: N/A Contact Carrier: Nylon PA6-GF30 Sleeves: N/A Contact Spring on Sleeves: N/A Pins: Nickel plated brass External Strain Relief Clamp: N/A Cable Seal: N/A Support Washer for Cord Grip: N/A Cover: N/A Hinge Pin: N/A Cover Spring: N/A Cover Gasket: N/A Flange Gasket: Silicon rubber Terminal Screws: Nickel plated steel Assembly Screws: Stainless steel

Specifications for IEC 309 watertight pin & sleeve mechanical interlocks

Product Description

20A; 2-pole, 3-wire grounding; 3-pole, 4-wire grounding; 4-pole, 5-wire grounding

Device Type	20A Non-Fusible Mechanical Interlocks	20A Fusible Mechanical Interlocks	20A Fuse Option Mechanical Interlocks	20A Circuit Breaker Option Mechanical Interlocks
Testing & Code Compliance:	Base Device: <ul style="list-style-type: none"> Conforms to IEC Standards 60309-1 and 60309-2 Listed to UL508, UL1682 & UL1686 CSA Certified to C22.2, no. 4-M91 	Base Device: <ul style="list-style-type: none"> Conforms to IEC Standards 60309-1 and 60309-2 Listed to UL98, UL1682 & UL1686 CSA Certified to C22.2, no. 4-M91 	Base Device: <ul style="list-style-type: none"> Conforms to IEC Standards 60309-1 and 60309-2 Listed to UL508, UL1682 & UL1686 CSA Certified to C22.2, no. 4-M91 	Base Device: <ul style="list-style-type: none"> Conforms to IEC Standards 60309-1 and 60309-2 Listed to UL508, UL1682 & UL1686 CSA Certified to C22.2, no. 4-M91
Specifications Environmental:	Flammability: Meets UL94 requirements; HB rated (housing),VO rated (contact carriers) Protection: NEMA 4X; 12 rated enclosure Watertight to IP66 per IEC 529	Flammability: Meets UL94 requirements; HB rated (housing),VO rated (contact carriers) Protection: NEMA 4X; 12 rated enclosure Watertight to IP66 per IEC 529	Flammability: Meets UL94 requirements; HB rated (housing),VO rated (contact carriers) Protection: NEMA 4X; 12 rated enclosure Watertight to IP66 per IEC 529	Flammability: Meets UL94 requirements; HB rated (housing),VO rated (contact carriers) Protection: NEMA 4X; 12 rated enclosure Watertight to IP66 per IEC 529
Specifications Electrical:	Dielectric Voltage: 3000V Maximum Working Voltage: 600V (rms) Current Interrupting: Yes, at full-rated current & voltage Temperature Rise: Max. 30°C (86°F) after 50 cycles of overload @150% of rated current Endurance: 5000 cycles	Dielectric Voltage: 3000V Maximum Working Voltage: 600V (rms) Current Interrupting: Yes, at full-rated current & voltage Temperature Rise: Max. 30°C (86°F) after 50 cycles of overload @150% of rated current Endurance: 5000 cycles	Dielectric Voltage: 3000V Maximum Working Voltage: 600V (rms) Current Interrupting: Yes, at full-rated current & voltage Temperature Rise: Max. 30°C (86°F) after 50 cycles of overload @150% of rated current Endurance: 5000 cycles	Dielectric Voltage: 3000V Maximum Working Voltage: 600V (rms) Current Interrupting: Yes, at full-rated current & voltage Temperature Rise: Max. 30°C (86°F) after 50 cycles of overload @150% of rated current Endurance: 5000 cycles
Specifications Mechanical:	Voltage Ratings: Marked on device Impact Resistance: CSA 22.2, 182.1 UL1682 Cable Grip Retention: CSA 22.2, 182.1 UL1682	Voltage Ratings: Marked on device Impact Resistance: CSA 22.2, 182.1 UL1682 Cable Grip Retention: CSA 22.2, 182.1 UL1682	Voltage Ratings: Marked on device Impact Resistance: CSA 22.2, 182.1 UL1682 Cable Grip Retention: CSA 22.2, 182.1 UL1682	Voltage Ratings: Marked on device Impact Resistance: CSA 22.2, 182.1 UL1682 Cable Grip Retention: CSA 22.2, 182.1 UL1682
Materials:	Enclosure Back Housing: UV stabilized Valox® Enclosure Cover: UV stabilized Valox® Enclosure Gasket: Poured-in-place, seamless Enclosure Fixing Screws: Stainless steel Receptacle Housing & Flange: PBT polyester & nylon/ABS blend Receptacle Contact Carrier/Support Isolators: Type 6/6 nylon Receptacle Sleeves: Brass Contact Spring on Sleeves: Nickel plated stainless steel Receptacle Rivet: PBT polyester Receptacle Cover: Type 6 nylon w/ PBT locking ring Receptacle Cover Spring: Stainless steel Receptacle Cover Gasket: NBR rubber Receptacle Flange Gasket: EPDM rubber Receptacle Terminal Screws: Nickel plated brass Receptacle Assembly Screws: Stainless steel	Enclosure Back Housing: UV stabilized Valox® Enclosure Cover: UV stabilized Valox® Enclosure Gasket: Poured-in-place, seamless Enclosure Fixing Screws: Stainless steel Receptacle Housing & Flange: PBT polyester & nylon/ABS blend Receptacle Contact Carrier/Support Isolators: Type 6/6 nylon Receptacle Sleeves: Brass Contact Spring on Sleeves: Nickel plated stainless steel Receptacle Rivet: PBT polyester Receptacle Cover: Type 6 nylon w/ PBT locking ring Receptacle Cover Spring: Stainless steel Receptacle Cover Gasket: NBR rubber Receptacle Flange Gasket: EPDM rubber Receptacle Terminal Screws: Nickel plated brass Receptacle Assembly Screws: Stainless steel	Enclosure Back Housing: UV stabilized Valox® Enclosure Cover: UV stabilized Valox® Enclosure Gasket: Poured-in-place, seamless Enclosure Fixing Screws: Stainless steel Receptacle Housing & Flange: PBT polyester & nylon/ABS blend Receptacle Contact Carrier/Support Isolators: Type 6/6 nylon Receptacle Sleeves: Brass Contact Spring on Sleeves: Nickel plated stainless steel Receptacle Rivet: PBT polyester Receptacle Cover: Type 6 nylon w/ PBT locking ring Receptacle Cover Spring: Stainless steel Receptacle Cover Gasket: NBR rubber Receptacle Flange Gasket: EPDM rubber Receptacle Terminal Screws: Nickel plated brass Receptacle Assembly Screws: Stainless steel	Enclosure Back Housing: UV stabilized Valox® Enclosure Cover: UV stabilized Valox® Enclosure Gasket: Poured-in-place, seamless Enclosure Fixing Screws: Stainless steel Receptacle Housing & Flange: PBT polyester & nylon/ABS blend Receptacle Contact Carrier/Support Isolators: Type 6/6 nylon Receptacle Sleeves: Brass Contact Spring on Sleeves: Nickel plated stainless steel Receptacle Rivet: PBT polyester Receptacle Cover: Type 6 nylon w/ PBT locking ring Receptacle Cover Spring: Stainless steel Receptacle Cover Gasket: NBR rubber Receptacle Flange Gasket: EPDM rubber Receptacle Terminal Screws: Nickel plated brass Receptacle Assembly Screws: Stainless steel

Specifications for IEC 309 watertight pin & sleeve mechanical interlocks

Product Description

30A; 2-pole, 3-wire grounding; 3-pole, 4-wire grounding; 4-pole, 5-wire grounding

Device Type	30A Pin & Sleeve Receptacles	30A Pin & Sleeve Plugs	30A Pin & Sleeve Connectors	30A Pin & Sleeve Inlets
Testing & Code Compliance:	Base Device: <ul style="list-style-type: none"> Conforms to IEC Standards 60309-1 and 60309-2 Listed to UL508, UL1682 & UL1686 CSA Certified to C22.2, no. 4-M91 	Base Device: <ul style="list-style-type: none"> Conforms to IEC standards 60309-1 and 60309-2 Listed to UL98, UL1682 & UL1686 CSA Certified to C22.2, no. 4-M91 	Base Device: <ul style="list-style-type: none"> Conforms to IEC standards 60309-1 and 60309-2 Listed to UL508, UL1682 & UL1686 CSA Certified to C22.2, no. 4-M91 	Base Device: <ul style="list-style-type: none"> Conforms to IEC standards 60309-1 and 60309-2 Listed to UL508, UL1682 & UL1686 CSA Certified to C22.2, no. 4-M91
Specifications Environmental:	Flammability: Meets UL94 requirements; 5V rated Protection: NEMA 4X; 12 rated enclosure Watertight to IP66 per IEC 529	Flammability: Meets UL94 requirements; 5V rated Protection: NEMA 4X; 12 rated enclosure Watertight to IP66 per IEC 529	Flammability: Meets UL94 requirements; 5V rated Protection: NEMA 4X; 12 rated enclosure Watertight to IP66 per IEC 529	Flammability: Meets UL94 requirements; 5V rated Protection: NEMA 4X; 12 rated enclosure Watertight to IP66 per IEC 529
Specifications Electrical:	Dielectric Voltage: 3000V Maximum Working Voltage: 600V (rms) Current Interrupting: Yes, at full-rated current & voltage Temperature Rise: Max. 30°C (86°F) after 50 cycles of overload @150% of rated current Endurance: 5000 cycles	Dielectric Voltage: 3000V Maximum Working Voltage: 600V (rms) Current Interrupting: Yes, at full-rated current & voltage Temperature Rise: Max. 30°C (86°F) after 50 cycles of overload @150% of rated current Endurance: 5000 cycles	Dielectric Voltage: 3000V Maximum Working Voltage: 600V (rms) Current Interrupting: Yes, at full-rated current & voltage Temperature Rise: Max. 30°C (86°F) after 50 cycles of overload @150% of rated current Endurance: 5000 cycles	Dielectric Voltage: 3000V Maximum Working Voltage: 600V (rms) Current Interrupting: Yes, at full-rated current & voltage Temperature Rise: Max. 30°C (86°F) after 50 cycles of overload @150% of rated current Endurance: 5000 cycles
Specifications Mechanical:	Voltage Ratings: Marked on device Impact Resistance: CSA 22.2, 182.1 UL1682 Cable Grip Retention: CSA 22.2, 182.1 UL1682	Voltage Ratings: Marked on device Impact Resistance: CSA 22.2, 182.1 UL1682 Cable Grip Retention: CSA 22.2, 182.1 UL1682	Voltage Ratings: Marked on device Impact Resistance: CSA 22.2, 182.1 UL1682 Cable Grip Retention: CSA 22.2, 182.1 UL1682	Voltage Ratings: Marked on device Impact Resistance: CSA 22.2, 182.1 UL1682 Cable Grip Retention: CSA 22.2, 182.1 UL1682
Materials:	Enclosure Back Housing: UV stabilized Valox® Enclosure Cover: UV stabilized Valox® Enclosure Gasket: Poured-in-place, seamless Enclosure Fixing Screws: Stainless steel Receptacle Housing & Flange: PBT polyester & nylon/ABS blend Receptacle Contact Carrier/Support Isolators: Type 6/6 nylon Receptacle Sleeves: Brass Contact Spring on Sleeves: Nickel plated stainless steel Receptacle Rivet: PBT polyester Receptacle Cover: Type 6 nylon w/ PBT locking ring Receptacle Cover Spring: Stainless steel Receptacle Cover Gasket: NBR rubber Receptacle Flange Gasket: EPDM rubber Receptacle Terminal Screws: Nickel plated brass Receptacle Assembly Screws: Stainless steel	Enclosure Back Housing: UV stabilized Valox® Enclosure Cover: UV stabilized Valox® Enclosure Gasket: Poured-in-place, seamless Enclosure Fixing Screws: Stainless steel Receptacle Housing & Flange: PBT polyester & nylon/ABS blend Receptacle Contact Carrier/Support Isolators: Type 6/6 nylon Receptacle Sleeves: Brass Contact Spring on Sleeves: Nickel plated stainless steel Receptacle Rivet: PBT polyester Receptacle Cover: Type 6 nylon w/ PBT locking ring Receptacle Cover Spring: Stainless steel Receptacle Cover Gasket: NBR rubber Receptacle Flange Gasket: EPDM rubber Receptacle Terminal Screws: Nickel plated brass Receptacle Assembly Screws: Stainless steel	Enclosure Back Housing: UV stabilized Valox® Enclosure Cover: UV stabilized Valox® Enclosure Gasket: Poured-in-place, seamless Enclosure Fixing Screws: Stainless steel Receptacle Housing & Flange: PBT polyester & nylon/ABS blend Receptacle Contact Carrier/Support Isolators: Type 6/6 nylon Receptacle Sleeves: Brass Contact Spring on Sleeves: Nickel plated stainless steel Receptacle Rivet: PBT polyester Receptacle Cover: Type 6 nylon w/ PBT locking ring Receptacle Cover Spring: Stainless steel Receptacle Cover Gasket: NBR rubber Receptacle Flange Gasket: EPDM rubber Receptacle Terminal Screws: Nickel plated brass Receptacle Assembly Screws: Stainless steel	Enclosure Back Housing: UV stabilized Valox® Enclosure Cover: UV stabilized Valox® Enclosure Gasket: Poured-in-place, seamless Enclosure Fixing Screws: Stainless steel Receptacle Housing & Flange: PBT polyester & nylon/ABS blend Receptacle Contact Carrier/Support Isolators: Type 6/6 nylon Receptacle Sleeves: Brass Contact Spring on Sleeves: Nickel plated stainless steel Receptacle Rivet: PBT polyester Receptacle Cover: Type 6 nylon w/ PBT locking ring Receptacle Cover Spring: Stainless steel Receptacle Cover Gasket: NBR rubber Receptacle Flange Gasket: EPDM rubber Receptacle Terminal Screws: Nickel plated brass Receptacle Assembly Screws: Stainless steel

Specifications for IEC 309 watertight pin & sleeve mechanical interlocks

Product Description

60A & 100A; 2-pole, 3-wire grounding; 3-pole, 4-wire grounding; 4-pole, 5-wire grounding

Device Type	60A & 100A Non-Fusible Mechanical Interlocks	60A & 100A Fusible Mechanical Interlocks	60A & 100A Fuse Option Mechanical Interlocks	60A & 100A Circuit Breaker Option Mechanical Interlocks
Testing & Code Compliance:	Base Device: <ul style="list-style-type: none"> Conforms to IEC standards 60309-1 and 60309-2 Listed to UL508, UL1682 & UL1686 CSA Certified to C22.2, no. 4-M91 	Base Device: <ul style="list-style-type: none"> Conforms to IEC standards 60309-1 and 60309-2 Listed to UL98, UL1682 & UL1686 CSA Certified to C22.2, no. 4-M91 	Base Device: <ul style="list-style-type: none"> Conforms to IEC standards 60309-1 and 60309-2 Listed to UL508, UL1682 & UL1686 CSA Certified to C22.2, no. 4-M91 	Base Device: <ul style="list-style-type: none"> Conforms to IEC standards 60309-1 and 60309-2 Listed to UL508, UL1682 & UL1686 CSA Certified to C22.2, no. 4-M91
Specifications Environmental:	Flammability: Meets UL94 requirements; 5V rated Protection: NEMA 4X; 12 rated enclosure Watertight to IP66 per IEC 529	Flammability: Meets UL94 requirements; 5V rated Protection: NEMA 4X; 12 rated enclosure Watertight to IP66 per IEC 529	Flammability: Meets UL94 requirements; 5V rated Protection: NEMA 4X; 12 rated enclosure Watertight to IP66 per IEC 529	Flammability: Meets UL94 requirements; 5V rated Protection: NEMA 4X; 12 rated enclosure Watertight to IP66 per IEC 529
Specifications Electrical:	Dielectric Voltage: 3000V Maximum Working Voltage: 600V (rms) Current Interrupting: Yes, at full-rated current & voltage Temperature Rise: Max. 30°C (86°F) after 50 cycles of overload @150% of rated current Endurance: 5000 cycles	Dielectric Voltage: 3000V Maximum Working Voltage: 600V (rms) Current Interrupting: Yes, at full-rated current & voltage Temperature Rise: Max. 30°C (86°F) after 50 cycles of overload @150% of rated current Endurance: 5000 cycles	Dielectric Voltage: 3000V Maximum Working Voltage: 600V (rms) Current Interrupting: Yes, at full-rated current & voltage Temperature Rise: Max. 30°C (86°F) after 50 cycles of overload @150% of rated current Endurance: 5000 cycles	Dielectric Voltage: 3000V Maximum Working Voltage: 600V (rms) Current Interrupting: Yes, at full-rated current & voltage Temperature Rise: Max. 30°C (86°F) after 50 cycles of overload @150% of rated current Endurance: 5000 cycles
Specifications Mechanical:	Voltage Ratings: Marked on device Impact Resistance: CSA 22.2, 182.1 UL1682 Cable Grip Retention: CSA 22.2, 182.1 UL1682	Voltage Ratings: Marked on device Impact Resistance: CSA 22.2, 182.1 UL1682 Cable Grip Retention: CSA 22.2, 182.1 UL1682	Voltage Ratings: Marked on device Impact Resistance: CSA 22.2, 182.1 UL1682 Cable Grip Retention: CSA 22.2, 182.1 UL1682	Voltage Ratings: Marked on device Impact Resistance: CSA 22.2, 182.1 UL1682 Cable Grip Retention: CSA 22.2, 182.1 UL1682
Materials:	Enclosure Back Housing: UV stabilized Valox® Enclosure Cover: UV stabilized Valox® Enclosure Gasket: Poured-in-place, seamless Enclosure Fixing Screws: Stainless steel Receptacle Housing & Flange: PBT polyester & nylon/ABS blend Receptacle Contact Carrier/Support Isolators: Type 6/6 nylon Receptacle Sleeves: Brass Contact Spring on Sleeves: Nickel plated stainless steel Receptacle Rivet: PBT polyester Receptacle Cover: Type 6 nylon w/ PBT locking ring Receptacle Cover Spring: Stainless steel Receptacle Cover Gasket: NBR rubber Receptacle Flange Gasket: EPDM rubber Receptacle Terminal Screws: Nickel plated brass Receptacle Assembly Screws: Stainless steel	Enclosure Back Housing: UV stabilized Valox® Enclosure Cover: UV stabilized Valox® Enclosure Gasket: Poured-in-place, seamless Enclosure Fixing Screws: Stainless steel Receptacle Housing & Flange: PBT polyester & nylon/ABS blend Receptacle Contact Carrier/Support Isolators: Type 6/6 nylon Receptacle Sleeves: Brass Contact Spring on Sleeves: Nickel plated stainless steel Receptacle Rivet: PBT polyester Receptacle Cover: Type 6 nylon w/ PBT locking ring Receptacle Cover Spring: Stainless steel Receptacle Cover Gasket: NBR rubber Receptacle Flange Gasket: EPDM rubber Receptacle Terminal Screws: Nickel plated brass Receptacle Assembly Screws: Stainless steel	Enclosure Back Housing: UV stabilized Valox® Enclosure Cover: UV stabilized Valox® Enclosure Gasket: Poured-in-place, seamless Enclosure Fixing Screws: Stainless steel Receptacle Housing & Flange: PBT polyester & nylon/ABS blend Receptacle Contact Carrier/Support Isolators: Type 6/6 nylon Receptacle Sleeves: Brass Contact Spring on Sleeves: Nickel plated stainless steel Receptacle Rivet: PBT polyester Receptacle Cover: Type 6 nylon w/ PBT locking ring Receptacle Cover Spring: Stainless steel Receptacle Cover Gasket: NBR rubber Receptacle Flange Gasket: EPDM rubber Receptacle Terminal Screws: Nickel plated brass Receptacle Assembly Screws: Stainless steel	Enclosure Back Housing: UV stabilized Valox® Enclosure Cover: UV stabilized Valox® Enclosure Gasket: Poured-in-place, seamless Enclosure Fixing Screws: Stainless steel Receptacle Housing & Flange: PBT polyester & nylon/ABS blend Receptacle Contact Carrier/Support Isolators: Type 6/6 nylon Receptacle Sleeves: Brass Contact Spring on Sleeves: Nickel plated stainless steel Receptacle Rivet: PBT polyester Receptacle Cover: Type 6 nylon w/ PBT locking ring Receptacle Cover Spring: Stainless steel Receptacle Cover Gasket: NBR rubber Receptacle Flange Gasket: EPDM rubber Receptacle Terminal Screws: Nickel plated brass Receptacle Assembly Screws: Stainless steel

Visit our website:
www.Arrowhart.com

Electrical Sector
203 Cooper Circle
Peachtree City, GA 30269
United States
Eaton.com
Arrowhart.com

Electrical Sector
Canada Operations
5925 McLaughlin Road
Mississauga, Ontario, L5R 1B8
Canada
EatonCanada.ca
Arrowhart.com

Electrical Sector
Mexico Operations
Carr. Tlalnepantla -
Cauatitlan Km 17.8 s/n
Col. Villa Jardin esq.
Cerrada 8 de Mayo
Cauatitlan, Mexico CP 54800
Mexico
Eaton.mx
Arrowhart.com

Eaton
1000 Eaton Boulevard
Cleveland, OH 44122
United States
Eaton.com

© 2015 Eaton
All Rights Reserved
Printed in USA
Publication No. BR630001EN
September 2015

Eaton is a registered trademark.
All other trademarks are property
of their respective owners.

