

Mercmaster™ Jr. Luminaires

High Pressure Sodium. Suitable for Use in Wet Locations

UNILETS® for Use with Threaded Metal Conduit. 120 V Integral Ballast. Medium Base Socket for Medium Base Lamps.

With Globe:

35 W, 50 W: †

Class I, Division 2, Groups A, B, C, D

Class II, Division 1 and 2, Groups E ‡, F, G

Class III

70 W: †

Class I, Division 2, Groups A, B, C, D

Class II, Division 1 and 2, Groups E ‡, F, G

100 W, 150 W: †

Class I, Division 2, Groups A, B, C, D

With Refractor (NEMA V):

35 W, 50 W, 70 W, 100 W: †

Class I, Division 2, Groups A, B, C, D

Class II, Division 1 and 2, Groups E ‡, F, G

Class III

150 W: †

Class I, Division 2, Groups A, B, C, D

Applications

- Inexpensive HID integrally ballasted fixture for use in hazardous locations – inexpensive to buy and inexpensive to operate (uses one-fifth as much electrical energy as incandescent and three-quarters as much as fluorescent).
- Enclosed and gasketed HID lighting fixtures for use in tunnels, walkways, bridges, storage facilities, processing plants, parking lots, foundries, manufacturing plants, power plants and other locations where moisture, dirt, dust or corrosive atmospheres are encountered.

Features

- “Wireless” design. Threading of fixture unit onto mounting hood makes electrical connection. Only wiring required is attaching two wires to connection block in mounting hood.
- Safe, easy servicing without disconnecting any wiring. “Wireless” fixture unit easily threads off mounting hood for convenient servicing.
- Quick, easy conversion from Appleton V-51® incandescent installation to Mercmaster Jr. HID. Just remove V-51® fixture unit and thread Mercmaster Jr. fixture unit onto existing V-51® mounting hood.
- Choice of mounting hoods. Standard fixtures in pendant, ceiling, outlet box, wall and stanchion mountings.
- Standard pendant mounting hood for rigid or flexible mounting. Balanced round design automatically hangs plumb when used with flexible hanger.
- Unitized construction reduces installation and maintenance costs.
- Ballast has standard non-PCB biodegradable capacitors.
- Medium base socket is furnished with 392 °F/200 °C leads, prewired to the ballast. Porcelain socket assures trouble-free operation in high ambient installations.
- Prismatic glass globe or glass refractor is standard and threads directly into fixture housing. Eliminates glare and provides uniform light distribution.
- Fiberglass reinforced polyester reflector for exceptionally severe corrosive atmospheres. Vented for cooler, dirt-free operation, increased lumen output.

Standard Materials

- Mounting hoods: copperfree (4/10 of 1% max.) aluminum or malleable iron
- Ballast bodies: copperfree (4/10 of 1% max.) aluminum
- Guards: copperfree (4/10 of 1% max.) aluminum or steel
- Reflectors: fiberglass reinforced polyester or porcelain
- Globe: 35 W-100 W, threaded prismatic glass and threaded polycarbonate; 150 W, threaded heat-resistant prismatic glass
- Refractor: heat-resistant prismatic glass

Standard Finishes

- Ballast bodies, aluminum guard and VMA, VXHA-A, OBVW1-A, OBV1-A, JBW1-A, JB1-A, GSW2 and MS mounting hoods: epoxy powder coat finish, electrostatically applied for complete, uniform surface protection
- VA, VXHA, OBVW1, OBV1, GS-2, JBW1, and JB1 malleable iron mounting hoods: triple coat – (1) zinc electroplate; (2) chromate; and (3) epoxy powder coat
- Steel guard: zinc electroplate

† The MJBW Wall Mount Fixture is suitable for Class I, Division 2, Groups A, B, C and D only.

‡ Per NEC 500.6(1), there is no such classification as Class II, Division 2, Group E.



Illustrated Feature

Conversion from Appleton V-51 incandescent installation to HID Mercmaster Jr. is easy and fast.



Step No. 1:

After power is shut off, remove present incandescent V-51 fixture unit from existing V-51 mounting hood.



Step No. 2:

Thread Mercmaster Jr. HID fixture unit onto existing V-51 mounting hood – and conversion is completed.

Options

- Fuses for fixtures, factory installed. Add suffix -F.

Certifications and Compliances

- UL Standard: UL 1598, UL 1598A, UL 844
- UL Listed: E10444

Mercmaster™ Jr. Luminaire Classified Area Suitability and Ballast Data

High Pressure Sodium. Suitable for Use in Wet Locations

UNILETS® for Use with Threaded Metal Conduit. 120 V Integral Ballast. Medium Base Socket for Medium Base Lamps.

With Globe:

35 W, 50 W: †
Class I, Division 2, Groups A, B, C, D
Class II, Division 1 and 2, Groups E ‡, F, G
Class III

70 W: †

Class I, Division 2, Groups A, B, C, D
Class II, Division 1 and 2, Groups E ‡, F

100 W, 150 W: †

Class I, Division 2, Groups A, B, C, D

With Refractor (NEMA V):

35 W, 50 W, 70 W, 100 W: †
Class I, Division 2, Groups A, B, C, D
Class II, Division 1 and 2, Groups E ‡, F, G
Class III

150 W: †

Class I, Division 2, Groups A, B, C, D

Thermal Suitability

Table at below shows maximum operating temperatures of Mercmaster Jr. fixtures for Class I, Division 2, in a 104 °F/40 °C ambient. Per NEC 500.8(B)(4), the temperature marking on fixtures shall not exceed the ignition temperature of the specific gas or vapor to be encountered. NEC 500.8(B)(4) states that these markings (Identification Numbers) "marked on equipment nameplates shall be in accordance with Table NEC 500.8(C)." This NEC table is duplicated, as it applies to Appleton Mercmaster Jr. fixtures, in the table below.

As shown, the higher the Temperature Identification Number, the cooler the fixture operates. Keep this in mind when selecting a fixture for a specific gas or vapor.

Example:

- Gasoline (56-60 octane)
- Fixture with Globe and Reflector

To determine Mercmaster Jr. thermal suitability for the above example:

- Check the Thermal Suitability on the following page for ignition temperature of gas or vapor to be encountered. It reveals that 56-60 octane gasoline has an ignition temperature of 536 °F/280 °C.
- Look in table below for fixtures under "With Globe and Reflector" that do not exceed the 536 °F/280 °C ignition temperature of the gasoline.
- Select the best fixture for your purpose. The 35 W, 50 W, 70 W or 100 W fixture with globe and reflector is acceptable because none of these fixture lamp surfaces exceed the 536 °F/280 °C ignition temperature of the gasoline.

Temperature Identification Numbers

Class I, Division 2, Groups A, B, C and D					Class II, Division 1 and 2, Groups E, F and G		
With Globe or with Globe and Reflector			With 8" Refractor		With Globe, with Globe and Reflector, or with 8" Refractor		
Lamp Watts	Nameplate Marking	Temperature Range (°F/°C)	Nameplate Marking	Temperature Range (°F/°C)	Nameplate Marking	Temperature Range (°F/°C)	Groups
35	T4	250-275 / 121-135	T4	250-275 / 121-135	T4C	214-248 / 101-120	E, F, G
50	T2D	394-419 / 201-215	T3	358-392 / 181-200	T3C	277-320 / 136-160	E, F, G
70	T2B	448-500 / 231-260	T2C	421-446 / 216-230	T3B	322-329 / 161-165	E, F, G ①
100	T2A	502-536 / 261-280	T2B	448-500 / 231-260	—	—	E, F, G ②
150	T2	538-572 / 281-300	T2A	502-536 / 261-280	—	—	—

Ambient Suitability of Mercmaster Jr. Fixtures

All fixtures suitable for operation at -40 °F/-40 °C.

35W	50W	70W	100W	150W
104 °F/ 40 °C	104 °F/ 40 °C	77 °F/ 25 °C	77 °F/ 25 °C	77 °F/ 25 °C

Retrofits Incandescent Fixtures Easily and Quickly

- 35 W HPS Comparable to 100/150 W Incandescent Lamp
- 50 W HPS Comparable to 200 W Incandescent Lamp
- 70 W HPS Comparable to 300 W Incandescent Lamp
- 100 W HPS Comparable to 1.5 300 W Incandescent Lamp ③
- 150 W HPS Comparable to 2.5 300 W Incandescent Lamp ③

Electrical Specifications (Reactor Ballasts)

Lamp Watts	Line Voltage 60 Hz	Line Current in Amperes		Input Watts
		Starting HPF	Operating HPF	
35	120	0.41	0.38	43
50	120	0.62	0.56	60
70	120	0.70	0.73	82
100	120	1.10	1.00	115
150	120	1.70	1.50	170

Optional Factory-Installed Fuses – Add Suffix -F

Available as a factory installed item with Mercmaster Jr. fixtures.

① 70W suitable for Groups E and F with globe; suitable for Groups E, F, and G with refractor.

② 100W suitable for Groups E, F and G with refractor only.

③ These are guidelines only. Light distribution and other factors must be taken into consideration.

† The MJBW Wall Mount Fixture is suitable for Class I, Division 2, Groups A, B, C and D only.

‡ Per NEC 500.6(1), there is no such classification as Class II, Division 2, Group E.

Mercmaster™ Jr. Luminaires

35 W, 50 W, 70 W, 100 W, 150 W HPS

Complete with Mounting Hood. Medium Base Socket. High Power Factor (Min. P.F. 90%). Integral Ballast for 120 V Line Operation.

With Globe:

35 W, 50 W: †

Class I, Division 2, Groups A, B, C, D

Class II, Division 1 and 2, Groups E ‡, F, G

Class III

70 W: †

Class I, Division 2, Groups A, B, C, D

Class II, Division 1 and 2, Groups E ‡, F

100 W, 150 W: †

Class I, Division 2, Groups A, B, C, D

With Refractor (NEMA V):

35 W, 50 W, 70 W, 100 W: †











Class I, Division 2, Groups A, B, C, D

Class II, Division 1 and 2, Groups E ‡, F, G

Class III

150 W: †

Class I, Division 2, Groups A, B, C, D

With Globe, Less Guard	With Refractor (NEMA V)	Lamp Watts	ANSI Lamp Type	Hub Size (Inches)	With Globe, Less Guard	Catalog Number ⑥	With Refractor (NEMA V)
Pendant — Aluminum mounting hood and ballast body. One Hub, Rigid or Flexible Mounting							
		35	S76	3/4 1	MA3575-120 MA3510-120	MA3575J-120 MA3510J-120	
		50	S68	3/4 1	MA5075-120 MA5010-120	MA5075J-120 MA5010J-120	
		70	S62	3/4 1	MA7075-120 MA7010-120	MA7075J-120 MA7010J-120	
		100	S54	3/4 1	MA1075-120 MA1010-120	MA1075J-120 MA1010J-120	
		150	S55	3/4 1	MA1575-120 MA1510-120	MA1575J-120 MA1510J-120	
Ceiling — Aluminum mounting hood and ballast body. Five Hubs, Four Close-Up Plugs							
		35	S76	3/4 1	MC3575-120 MC3510-120	MC3575J-120 MC3510J-120	
		50	S68	3/4 1	MC5075-120 MC5010-120	MC5075J-120 MC5010J-120	
		70	S62	3/4 1	MC7075-120 MC7010-120	MC7075J-120 MC7010J-120	
		100	S54	3/4 1	MC1075-120 MC1010-120	MC1075J-120 MC1010J-120	
		150	S55	3/4 1	MC1575-120 MC1510-120	MC1575J-120 MC1510J-120	
Wall ② — Malleable iron mounting hood and aluminum ballast body. Gasket and screws furnished with fixture. Fits GSU Cast Boxes							
		35	S76	—	MGSW35-120	MGSW35J-120	
		50	S68	—	MGSW50-120	MGSW50J-120	
		70	S62	—	MGSW70-120	MGSW70J-120	
		100	S54	—	MGSW10-120	MGSW10J-120	
		150	S55	—	MGSW15-120	MGSW15J-120	
Wall ②② — Class I, Division 2 only. Aluminum mounting hood and ballast body. Gasket and screws furnished with fixture. Fits JBX Cast Boxes							
		35	S76	—	MJBW35-120	MJBW35J-120	
		50	S68	—	MJBW50-120	MJBW50J-120	
		70	S62	—	MJBW70-120	MJBW70J-120	
		100	S54	—	MJBW10-120	MJBW10J-120	
		150	S55	—	MJBW15-120	MJBW15J-120	
25° Stanchion ④ — Aluminum mounting hood and ballast body. One hub							
		35	S76	1-1/4	MS35125-120	MS35125J-120	
				1-1/2	MS35150-120	MS35150J-120	
		50	S68	1-1/4	MS50125-120	MS50125J-120	
				1-1/2	MS50150-120	MS50150J-120	
		70	S62	1-1/2	MS70125-120	MS70125J-120	
1-1/2	MS70150-120			MS70150J-120			
100	S54	1-1/4	MS10125-120	MS10125J-120			
		1-1/2	MS10150-120	MS10150J-120			
150	S55	1-1/4	MS15125-120	MS15125J-120			
		1-1/2	MS15150-120	MS15150J-120			

‡ Per NEC 500.6(1), there is no such classification as Class II, Division 2, Group E.

† The MJBW Wall Mount Fixture is suitable for Class I, Division 2, Groups A, B, C and D only.

② All fixtures on this page comply with UL Standard 844 except MJBW Wall Mount Fixture, which is not suitable for Class II, Division 1.

③ Using cast outlet box with Wall Mount Fixture provides the following clearances: for the globe – JBX box, 1-5/8" from wall; GSU box, 2" from wall; for the refractor – JBX box, 15/16" from wall; GSW box, 1-5/16" from wall. Reflectors cannot be used with the wall mount fixtures.

④ Stanchion Mount can be used with standard dome or 30° angle reflector.

⑥ To order fixture with guard, add -G before voltage (example: MA3575G-120).

Mercmaster™ Jr. Luminaires

High Pressure Sodium. Suitable for Use in Wet Locations

UNILETS® for Use with Threaded Metal Conduit. 120 V Integral Ballast. Medium Base Socket for Medium Base Lamps.

With Globe:

35 W, 50 W: †
Class I, Division 2, Groups A, B, C, D
Class II, Division 1 and 2, Groups E ‡, F, G
Class III

70 W: †

Class I, Division 2, Groups A, B, C, D
Class II, Division 1 and 2, Groups E ‡, F

100 W, 150 W: †



Class I, Division 2, Groups A, B, C, D

With Refractor (NEMA V):

35 W, 50 W, 70 W, 100 W: †
Class I, Division 2, Groups A, B, C, D
Class II, Division 1 and 2, Groups E ‡, F, G
Class III

150 W: †

Class I, Division 2, Groups A, B, C, D

With Globe	With 8" Refractor	Description	Lamp Watts	ANSI Lamp Type	Catalog Number	
					With Globe ❶	With 8" Refractor
Outlet Box Fixture						
		Aluminum ballast housing, complete with aluminum mounting hood. Epoxy clad.	35	S76	MOB35-120	MOB35J-120
			50	S68	MOB50-120	MOB50J-120
		Use with SEH and 3-1/4" or 4" Octagonal Outlet Box. Fixture furnished with mounting plate and gasket. Octagonal boxes not suitable for classified locations.	70	S62	MOB70-120	MOB70J-120
			100	S54	MOB10-120	MOB10J-120
			150	S55	MOB15-120	MOB15J-120

Fixture Units	Lamp Watts	ANSI Lamp Type	Catalog Number	
			With Globe ❶	With 8" Refractor
	S76	35	MUL35-120	
	S68	50	MUL50-120	
	S62	70	MUL70-120	
	S54	100	MUL100-120	
	S55	150	MUL150-120	

Ballast Bodies	Lamp Watts	ANSI Lamp Type	Catalog Number	
			With Globe ❶	With 8" Refractor
	S76	35	MBL35-120	
	S68	50	MBL50-120	
	S62	70	MBL70-120	
	S54	100	MBL100-120	
	S55	150	MBL150-120	

‡ Per NEC 500.6(1), there is no such classification as Class II, Division 2, Group E.
† The MJBW Wall Mount Fixture is suitable for Class I, Division 2, Groups A, B, C and D only.
❶ Order JBX or GSU box on following page.

Lighting
LIGHTING: ENCLOSED AND GASKETED — AREA — HID

Mercmaster™ Jr. Luminaire Dimensions

35 W, 50 W, 70 W, 100 W, 150 W

UNILETS® for Use with Threaded Metal Conduit. 120 V Integral Ballast. Medium Base Socket for Medium Base Lamps.

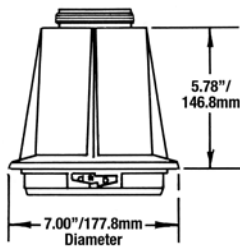

MBL Ballast Body

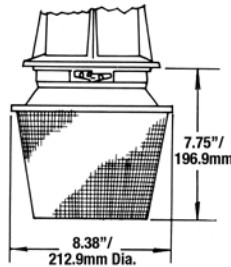

Fixture with 8" Refractor

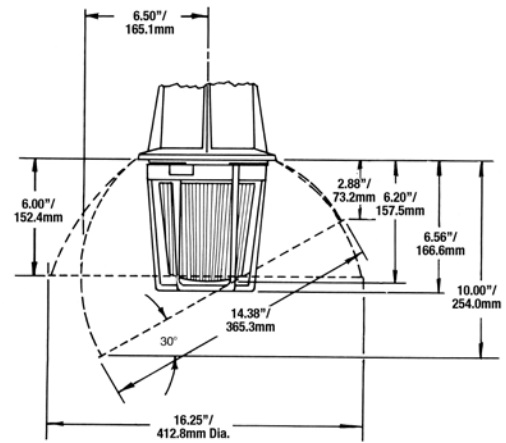

Fixture with Guard and Polyester Reflectors

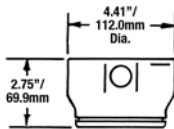

VXHA Ceiling Mount

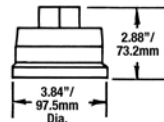

VMA Pendant Mount

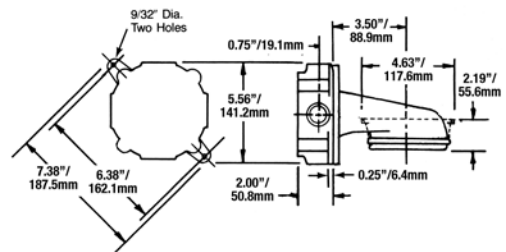

GSW Wall Mount ❶ and GS Ceiling Mount with GSU Box ❷

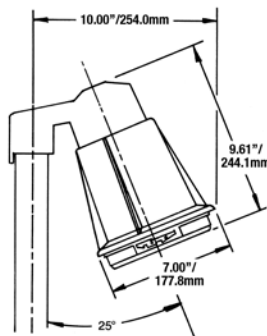

Stanchion Mount ❸

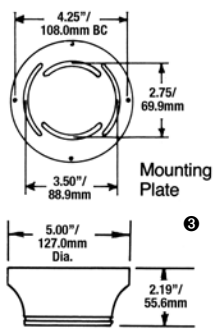

OBV Outlet Box Mount and Mounting Plate

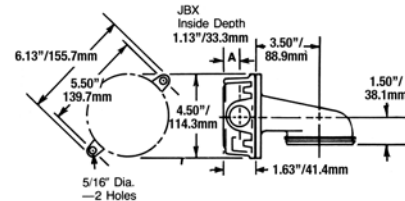

JBW Wall Mount ❶ with JBX Box ❷

❶ Mounting holes 9/32" diameter on 5-1/8" centers. Mounting plate is a separate piece furnished with outlet box mount fixture. The 2.75" dimension is for mounting on 3-1/4" octagonal boxes and the 3.50" dimension is for 4" octagonal boxes.

❷ Wall mount fixtures provide the following wall clearances: with GSU box – 2" from wall with globe and 1-5/16" from wall with refractor; with JBX box – 1-5/8" from wall with globe and 15/16" from wall with refractor. Reflectors cannot be used with wall mount fixtures.

❸ Order GSU or JBX box separately.

❹ Standard dome or 30° angle reflectors can be used with stanchion mount.