

SEH Conduit Outlet Boxes and Covers

UNILETS® for use with Threaded Rigid Metal Conduit and IMC. Furnished with Internal Ground Screw.

Applications

- Provide openings for splicing.
- Make straight connections and 90° bends in conduit runs.
- Permit access to conductors for maintenance.

Features

- Accepts 4" octagon outlet box covers.
- Two 8-32 screw holes tapped on 3-1/2" centers.
- Furnished with internal ground screw.

Standard Materials









- Conduit outlet boxes: malleable iron
- Covers: steel and cast malleable iron
- Gaskets: composition fiber

Standard Finishes

- Boxes and cast covers: triple-coat — (1) zinc electroplate, (2) chromate and (3) epoxy powder coat
- Blank steel cover: zinc electroplate

Certifications and Compliances

- UL Standard: 514A
- UL Listed: E2527

	Description	Hub Size (Inches)	Catalog Number
SEH 	SEH	1/2	SEH-50
		3/4	SEH-75
	SEHC	1/2	SEHC-50
		3/4	SEHC-75
	SEHL	1/2	SEHL-50
		3/4	SEHL-75
	SEHT	1/2	SEHT-50
		3/4	SEHT-75
	SEHX	1/2	SEHX-50
		3/4	SEHX-75
SEH Covers — Furnished with screws *			
	Hub cover, cast malleable	1/2 *	SEHK-50
	Cover, steel	Blank *	SEHK-B
	Cover, cast malleable	Blank *	SEHK-BC
SEH Gasket 	Fiber composition		SEH-GK

Dimensions and Wiring Capacity

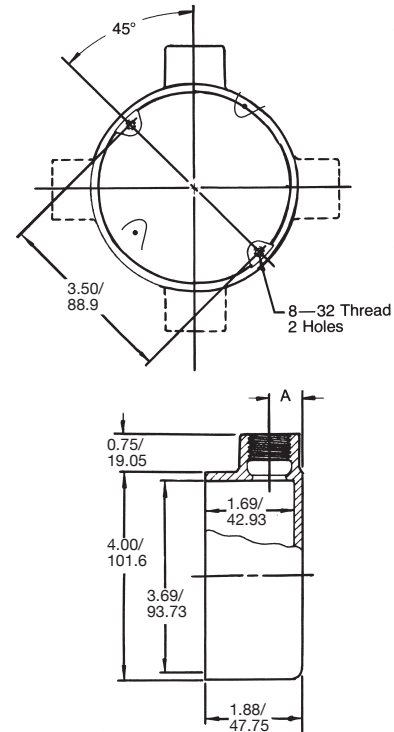

Hub Size (Inches)	Dimensions "A" Inches/Millimeters	Capacity (in ³ /dm ³)
1/2	0.63/16.0	18.00/0.29
3/4	0.75/19.1	18.00/0.29

SEH covers add no additional cubic inch capacity.

* CSA Certified only.