

# NEC 6x8x Series C, LB, UB and LL, LR, T Mogul Unilet® Conduit Outlet Bodies

For use with Threaded Rigid Metal Conduit and IMC. Complete with Assembled Cover and Neoprene Gasket.

## Applications

- Larger body size facilitates pulling of large and heavy conductors. Specially designed raised cast covers provide additional wiring area.
- Mogul Unilets® for pulling straight, 45° or 90° angle turns and/or making taps and splices.

## Features

- Exclusive built-in rollers facilitate cable pulling. Available on NEC 6x8x Series Moguls (C, LB and UB) in sizes 1-1/4" and up.
- Smooth, rounded integral bushing in each hub protects conductor insulation.
- Accurately tapped, tapered threads for tight, rigid joints and ground continuity.
- Covers have captive stainless steel screws to speed installation, prevent "freezing" of screws.
- LB and UB Moguls
  - Length Requirement: distance between centerline of each hub bushing (conduit stop) exceeds six times the trade diameter of the conduit per NEC 314.28(A)(2).
  - Bending Space Requirement: these moguls also meet the NEC 314.28(A)(2) Exception requirement spelled out in NEC 312.6(A) Table.
- C Moguls
  - Length Requirement: distance between centerline of each hub bushing (conduit stop) exceeds eight times the trade diameter of the conduit per NEC 314.28(A)(1).
  - Bending Space Requirement: not applicable.
- LL and LR Moguls
  - Like LB moguls, these moguls have an end hub.
  - The second hub is in the side (LL left and LR right) instead of the back.
- T Moguls
  - These are like "C" moguls (1" thru 4"), except with an additional middle side hub.
  - Distance between the centerline of each "C" hub conduit stop exceeds eight times the trade diameter of the conduit per NEC 314.28(A)(1). ①

## Standard Materials

- Bodies and covers: malleable iron or copperfree (4/10 of 1% max.) aluminum
- Gaskets: neoprene
- Screws: stainless steel

## Standard Finishes

- Malleable iron bodies and covers: triple-coat — (1) zinc electroplate, (2) chromate and (3) epoxy powder coat
- Aluminum bodies and covers: epoxy powder coat

## NEC/CEC Certifications and Compliances

- UL Standard: 514B
- UL Listed: E2527
- CSA Standard: C22.2 No. 18.3
- CSA Certified: 065183
- NEMA Standard: FB-1



C Type NEC 8x



LB Type 1" – 2"  
NEC 6x



LB Type 2-1/2" – 4"  
NEC 6x



UB Type NEC 6x



LR Type NEC 6x



LL Type NEC 6x



T Type NEC 8x



Rollers make cable-pulling easier, eliminate insulation damage

Fittings

NEC/CEC CONDUIT BODIES







① If less than maximum conductors permitted by NEC are used, smaller wires may be used additionally through "LL", "LR" or "T" hubs. If large conductors are required to be bent in "LL", "LR" or "T" direction, order junction boxes instead. See Enclosures and Junction Boxes.

# NEC 6x8x Series C, LB, UB Mogul Unilet® Conduit Outlet Bodies

For use with Threaded Rigid Metal Conduit and IMC. Complete with Assembled Cover and Neoprene Gasket.

Fittings





NEC/CEC CONDUIT BODIES

Type	Hub Size (Inches)	Body, Cover and Gasket			Cover and Gasket		
		Malleable Iron	Aluminum	Gasket Only	Malleable Iron	Aluminum	
<b>C NEC 8X</b>							
 <p>1" - 2"</p>	1	BC100-M	BC100-A	BG100	BKG100-M	BKG100-A	
	1-1/4	BC125-M ①	BC125-A ①	BGC125	BKGC125-M	BKGC125-A	
	1-1/2	BC150-M ①	BC150-A ①	BG150	BKG150-M	BKG150-A	
	2	BC200-M ①	BC200-A ①	BGC200	BKGC200-M	BKGC200-A	
 <p>2-1/2" - 4"</p>	2-1/2	BC250-M ①	BC250-A ①	BGC250	BKGC250-M	BKGC250-A	
	3	BC300-M ①	BC300-A ①	BGC300	BKGC300-M	BKGC300-A	
	3-1/2	BC350-M ①	BC350-A ①	BGC350	BKGC350-M	BKGC350-A	
	4	BC400-M ①	BC400-A ①	BGC400	BKGC400-M	BKGC400-A	
<b>LB NEC 6X</b>							
 <p>1" - 2"</p>	1	BLB100-M	BLB100-A	BG100	BKG100-M	BKG100-A	
	1-1/4	BLB125-M ①	BLB125-A ①	BGL125	BKGL125-M	BKGL125-A	
	1-1/2	BLB150-M ①	BLB150-A ①	BG150	BKG150-M	BKG150-A	
 <p>2-1/2" - 4"</p>	2	BLB200-M ①	BLB200-A ①	BGL200	BKGL200-M	BKGL200-A	
	2-1/2	BLB250-M ①	BLB250-A ①	BGL250	BKGL250-M	BKGL250-A	
	3	BLB300-M ①	BLB300-A ①	BGL300	BKGL300-M	BKGL300-A	
	3-1/2	BLB350-M ①	BLB350-A ①	BGL350	BKGL350-M	BKGL350-A	
 <p>2-1/2" - 4"</p>	4	BLB400-M ①	BLB400-A ①	BGL400	BKGL400-M	BKGL400-A	
	<b>UB NEC 6X</b>						
	 <p>1" - 2"</p>	1	BUB100-M	BUB100-A	BG100	BKG100-M	BKG100-A
		1-1/4	BUB125-M ①	BUB125-A ①	BGL125	BKGL125-M	BKGL125-A
		1-1/2	BUB150-M ①	BUB150-A ①	BG150	BKG150-M	BKG150-A
	 <p>2-1/2" - 4"</p>	2	BUB200-M ①	BUB200-A ①	BGL200	BKGL200-M	BKGL200-A
2-1/2		BUB250-M ①	BUB250-A ①	BGL250	BKGC250-M	BKGC250-A	
3		BUB300-M ①	BUB300-A ①	BGL300	BKGU300-M	BKGU300-A	
3-1/2		BUB350-M ①	BUB350-A ①	BGL350	BKGC350-M	BKGC350-A	
4	BUB400-M ①	BUB400-A ①	BGL400	BKGU400-M	BKGU400-A		

① Furnished with rollers for easier cable pulling.

# NEC 6x8x Series LL, LR, T Mogul Unilet® Conduit Outlet Bodies and Wiring Capacity

For use with Threaded Rigid Metal Conduit and IMC. Complete with Assembled Cover and Neoprene Gasket.

Type	Hub Size (Inches)	Body, Cover and Gasket			Cover and Gasket	
		Malleable Iron	Aluminum	Gasket Only	Malleable Iron	Aluminum
<b>LL NEC 6X</b>						
 1" – 2"	1	BLL100-M	BLL100-A	BG100	BKG100-M	BKG100-A
	1-1/4	BLL125-M	BLL125-A	BGL125	BKGL125-M	BKGL125-A
	1-1/2	BLL150-M	BLL150-A	BG150	BKG150-M	BKG150-A
	2	BLL200-M	BLL200-A	BGL200	BKGL200-M	BKGL200-A
<b>LR NEC 6X</b>						
 1" – 2"	1	BLR100-M	BLR100-A	BG100	BKG100-M	BKG100-A
	1-1/4	BLR125-M	BLR125-A	BGL125	BKGL125-M	BKGL125-A
	1-1/2	BLR150-M	BLR150-A	BG150	BKG150-M	BKG150-A
	2	BLR200-M	BLR200-A	BGL200	BKGL200-M	BKGL200-A
<b>T NEC 8X</b>						
 1" – 2"	1	BT100-M	BT100-A	BG100	BKG100-M	BKG100-A
	1-1/4	BT125-M	BT125-A	BGC125	BKGC125-M	BKGC125-A
	1-1/2	BT150-M	BT150-A	BG150	BKG150-M	BKG150-A
	2	BT200-M	BT200-A	BGC200	BKGC200-M	BKGC200-A
 2-1/2" – 4"	2-1/2	BT250-M	BT250-A	BGC250	BKGC250-M	BKGC250-A
	3	BT300-M	BT300-A	BGC300	BKGC300-M	BKGC300-A
	3-1/2	BT350-M	BT350-A	BGC350	BKGC350-M	BKGC350-A
	4	BT400-M	BT400-A	BGC400	BKGC400-M	BKGC400-A

## Wiring Capacity for Mogul Bodies with Covers: Malleable Iron and Aluminum

Hub Size (Inches)	Type Mogul	Capacity — dm <sup>3</sup> (in <sup>3</sup> )	Hub Size (Inches)	Type Mogul	Capacity — dm <sup>3</sup> (in <sup>3</sup> )
1	C, LB, LL, LR, T, UB	0.50 (31.00)	2-1/2	C, T	5.49 (335.00)
	C, T	0.82 (50.00)		LB	3.44 (210.00)
1-1/4	LB	0.79 (48.00)		UB	6.15 (375.00)
	LL, LR	0.69 (42.00)	3	C, T	7.78 (475.00)
	UB	0.66 (40.00)		LB	5.65 (345.00)
1-1/2	C, LL, LR, T	1.52 (93.00)	3-1/2	UB	7.29 (445.00)
	LB	1.75 (107.00)		C, T	13.60 (830.00)
	UB	1.49 (91.00)		LB	8.19 (500.00)
2	C, T	2.34 (143.00)	4	UB	13.77 (840.00)
	LB	2.37 (145.00)		C, T	16.55 (1010.00)
	LL, LR, UB	2.20 (134.00)		LB	12.13 (740.00)
				UB	15.73 (960.00)

# Bending Radius and Bending Space of NEC 6x8x Series LB and UB Mogul Bodies

Fittings  
NEC/CEC CONDUIT BODIES

## Bending Radius of Moguls

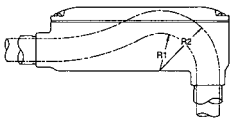
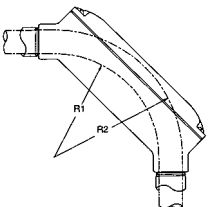
	Type	Catalog Number	Hub Size (Inches)	Millimeters (Inches)	
				R1	R2
 <b>LB Mogul 1" – 2"</b>	LB	BLB100-A,M	1	41.4 (1.63)	66.8 (2.63)
		BLB125-A,M	1-1/4	57.2 (2.25)	92.2 (3.63)
		BLB150-A,M	1-1/2	66.8 (2.63)	104.9 (4.13)
		BLB200-A,M	2	76.2 (3.00)	127.0 (5.00)
		BLB250-A,M	2-1/2	98.6 (3.88)	158.8 (6.25)
		BLB300-A,M	3	127.0 (5.00)	203.2 (8.00)
		BLB350-A,M	3-1/2	127.0 (5.00)	212.9 (8.38)
		BLB400-A,M	4	158.8 (6.25)	260.4 (10.25)
 <b>UB Mogul 1" – 4"</b>	UB	BUB100-A,M	1	114.3 (4.50)	139.7 (5.50)
		BUB125-A,M	1-1/4	117.6 (4.63)	152.4 (6.00)
		BUB150-A,M	1-1/2	177.8 (7.00)	215.9 (8.50)
		BUB200-A,M	2	190.5 (7.50)	241.3 (9.50)
		BUB250-A,M	2-1/2	333.5 (13.13)	393.7 (15.50)
		BUB300-A,M	3	352.6 (13.88)	428.8 (16.88)
		BUB350-A,M	3-1/2	501.7 (19.75)	590.6 (23.25)
		BUB400-A,M	4	527.1 (20.75)	628.7 (24.75)

## Compliances with NEC Bending Space Requirements

### Bending Space Defined

NEC 370.28(A)(2) Exception. This article applies to LB and UB Moguls, defines bending space and refers to NEC 312.6(B) Table as guideline for determining minimum bending space distance. Bending space is illustrated as Dimension "A" below:

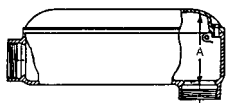

**LB Mogul 1" – 2"**

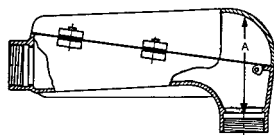

**LB Mogul 2-1/2" – 4"**

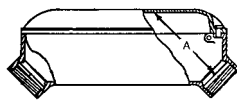

**UB Mogul 1" – 4"**

### Bending Space of Moguls (Dim. "A" in sketches at left)

Mogul Size	Type	Distance
1	LB, UB	2-1/2"
1-1/4	LB, UB	3-1/2"
1-1/2	LB, UB	4"
2	LB, UB	5"
2-1/2	LB, UB	6"
3	LB, UB	8"
3-1/2	LB, UB	8"
4	LB, UB	10"

*NOTE ON RADIUS TABLE: Secure cable or wire bending radius from manufacturer. Then select a mogul having this radius or more. If radius is 6-1/4", an LB 2-1/2" mogul or BUB 1-1/2" mogul is suitable.*

*NOTE ON NEC 312.6(B) TABLE: Because cable sizes vary, table is limited to single wire sizes. Use as guideline only for cable sizes.*

### Minimum Wire Bending Space

NEC 312.6(B) Table: The applicable portion of this table is shown below. Only the "1 Wire Per Terminal" column is retained, because the others are not applicable. *Example for using table below and table at right:* 350MCM wire size requires 5" bending space. A 2" LB or UB Appleton Mogul is suitable.

AWG or Circular-Mill. Size of Wire	1 Wire per Terminal Min. Bending Space
14-10	Not Specified
8-6	1-1/2"
4-3	2"
2	2-1/2"
1	3"
0-00	3-1/2"
000-0000	4"
250 MCM	4-1/2"
300-350 MCM	5"
400-500 MCM	6"
600-700 MCM	8"
750-900 MCM	8"
1,000-1,250 MCM	10"
1,500-2,000 MCM	12"

# NEC 6x8x Series C Mogul Bodies Comply with NEC Large-Wire Requirements

## Applicable NEC References for C, LB and UB Moguls

- **Straight Pull Length Requirements:** NEC 314.28(A)(2) — C Moguls "... shall not be less than eight times the trade diameter of the largest raceway." (See table at right.)
- **Angle or U Pull Length Requirements:** NEC 314.28(A)(2) — LB, UB Moguls "The distance between each raceway entry inside the box and the opposite wall of the box shall not be less than six times the trade diameter of the largest raceway." (See next page.)
- **Bending-Space Requirements:** NEC 314.28(A)(2). Exception 312.6(A) Table — LB, UB Moguls "Where a conduit or cable entry is in the wall of a box or conduit body opposite to a removable cover." (See dim. "A", table right)
- **Length and Bending Space Requirements:**

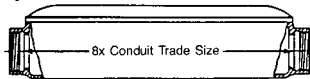

C Mogul— 1" thru 4"

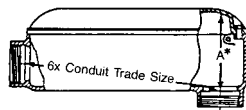

LB Mogul— 1" thru 2"

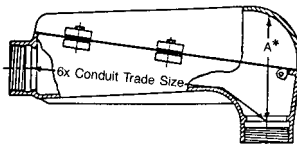

LB Mogul— 2-1/2" thru 4"

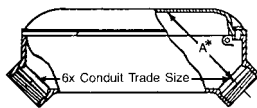

UB Mogul— 1" thru 4"

**BENDING SPACE EXAMPLE:** LB with 3" hubs (Cat. No. BLB300-M) using 500 MCM wire with four conductors.

Table on next page shows that, in this example, NEC requires a bending space of 6" and that the Appleton 3" LB provides a bending space of 8".

## C Moguls — Straight Pulls: Maximum Number of Conductors, Minimum Lengths

Wire Size ①	Maximum Number of Conductors per NEC ②	Length Requirements (Conduit Stop to Conduit Stop) Per		Maximum Number of Conductors per NEC ②	Length Requirements (Conduit Stop to Conduit Stop) Per	
		NEC ③	Appleton		NEC ③	Appleton
<b>1" Hubs – BC100-M and BC100-A</b>						
4	4	8"	8"	7	10"	10"
3	3	8"	8"	6	10"	10"
2	3	8"	8"	5	10"	10"
1	-	-	-	3	10"	10"
0	-	-	-	3	10"	10"
<b>1-1/2" Hubs – BC150-M and BC150-A</b>						
4	9	12"	12"	16	16"	16"
3	8	12"	12"	13	16"	16"
2	7	12"	12"	11	16"	16"
1	5	12"	12"	8	16"	16"
0	4	12"	12"	7	16"	16"
00	3	12"	12"	6	16"	16"
000	3	12"	12"	5	16"	16"
0000	-	-	-	4	16"	16"
250	-	-	-	3	16"	16"
300	-	-	-	3	16"	16"
<b>2" Hubs – BC200-M and BC200-A</b>						
<b>2-1/2" Hubs – BC250-M and BC250-A</b>						
4	22	20"	20"	35	24"	24"
3	19	20"	20"	29	24"	24"
2	16	20"	20"	25	24"	24"
1	12	20"	20"	18	24"	24"
0	10	20"	20"	15	24"	24"
00	8	20"	20"	13	24"	24"
000	7	20"	20"	11	24"	24"
0000	6	20"	20"	9	24"	24"
250	4	20"	20"	7	24"	24"
300	4	20"	20"	6	24"	24"
350	3	15"	20"	5	24"	24"
400	3	15"	20"	5	24"	24"
500	-	-	-	4	24"	24"
600	-	-	-	3	24"	24"
700	-	-	-	3	24"	24"
<b>3" Hubs – BC300-M and BC300-A</b>						
<b>3-1/2" Hubs – BC350-M and BC400-A</b>						
4	47	28"	28"	60	32"	32"
3	39	28"	28"	51	32"	32"
2	33	28"	28"	43	32"	32"
1	25	28"	28"	32	32"	32"
0	21	28"	28"	27	32"	32"
00	17	28"	28"	32	32"	32"
000	14	28"	28"	18	32"	32"
0000	12	28"	28"	15	32"	32"
250	10	28"	28"	12	32"	32"
300	8	28"	28"	11	32"	32"
350	7	28"	28"	9	32"	32"
400	6	28"	28"	8	32"	32"
500	5	28"	28"	7	32"	32"
600	4	28"	28"	5	32"	32"
700	4	28"	28"	5	32"	32"
750	3	28"	28"	4	32"	32"
800	3	28"	28"	4	32"	32"
900	3	28"	28"	4	32"	32"
1000	-	-	-	3	32"	32"

① NEC 370.28(A). Limited to minimum #4 wire.

② NEC Chapter 9, Table 3B.

③ NEC 370.28(A)(1). This is 8 times conduit trade size.

\* Dimension "A" is bending space.

# NEC 6x8x Series LB, UB Mogul Bodies Comply with NEC Large-Wire Requirements

LB and UB Moguls- Angle or U Pulls: Max. No. Conductors, Min. Lengths, Min. Bending Spaces

Wire Size ①	Maximum Number of Conductors per NEC ②	Length Requirements (Conduit Stop to Conduit Stop)		(A) Bending Space Requirements		Maximum Number of Conductors per NEC ②	Length Requirements (Conduit Stop to Conduit Stop)		(A) Bending Space Requirements		
		Per NEC ③	Appleton	Per NEC ③	Appleton		Per NEC ③	Appleton			
<b>1" Hubs – BLB100-M, BLB100-A, BUB100-M and BUB100-A</b>						<b>1-1/4" Hubs – BLB125-M, BLB125-A, BUB125-M and BUB200-A</b>					
4	4	6"	6"	2"	2-1/2"	7	7-1/2"	7-1/2"	2"	3-1/2"	
3	3	6"	6"	2"	2-1/2"	6	7-1/2"	7-1/2"	2"	3-1/2"	
2	3	6"	6"	2-1/2"	2-1/2"	5	7-1/2"	7-1/2"	2-1/2"	3-1/2"	
1	-	-	-	-	-	3	7-1/2"	7-1/2"	3"	3-1/2"	
0	-	-	-	-	-	3	7-1/2"	7-1/2"	3-1/2"	3-1/2"	
<b>1-1/2" Hubs – BLB150-M, BLB150-A, BUB150-M and BUB150-A</b>						<b>2" Hubs – BLB200-M, BLB200-A, BUB200-M and BUB200-A</b>					
4	9	9"	9"	2"	4"	16	12"	12"	2"	5"	
3	8	9"	9"	2"	4"	13	12"	12"	2"	5"	
2	7	9"	9"	2-1/2"	4"	11	12"	12"	2-1/2"	5"	
1	5	9"	9"	3"	4"	8	12"	12"	3"	5"	
0	4	9"	9"	3-1/2"	4"	7	12"	12"	3-1/2"	5"	
0	3	9"	9"	3-1/2"	4"	6	12"	12"	3-1/2"	5"	
0	3	9"	9"	4"	4"	5	12"	12"	4"	5"	
0	-	-	-	-	-	4	12"	12"	4"	5"	
250	-	-	-	-	-	3	12"	12"	4-1/2"	5"	
300	-	-	-	-	-	3	12"	12"	5"	5"	
<b>2-1/2" Hubs – BLB250-M, BLB250-A, BUB250-M and BUB250-A</b>						<b>3" Hubs – BLB300-M, BLB300-A, BUB300-M and BUB300-A</b>					
4	22	15"	15"	2"	6"	35	18"	18"	2"	8"	
3	19	15"	15"	2"	6"	29	18"	18"	2"	8"	
2	16	15"	15"	2-1/2"	6"	25	18"	18"	2-1/2"	8"	
1	12	15"	15"	3"	6"	18	18"	18"	3"	8"	
0	10	15"	15"	3-1/2"	6"	15	18"	18"	3-1/2"	8"	
0	8	15"	15"	3-1/2"	6"	13	18"	18"	3-1/2"	8"	
0	7	15"	15"	4"	6"	11	18"	18"	4"	8"	
0	6	15"	15"	4"	6"	9	18"	18"	4"	8"	
250	4	15"	15"	4-1/2"	6"	7	18"	18"	4-1/2"	8"	
300	4	15"	15"	5"	6"	6	18"	18"	5"	8"	
350	3	15"	15"	5"	6"	5	18"	18"	5"	8"	
400	3	15"	15"	6"	6"	5	18"	18"	6"	8"	
500	-	-	-	-	-	4	18"	18"	6"	8"	
600	-	-	-	-	-	3	18"	18"	8"	8"	
700	-	-	-	-	-	3	18"	18"	8"	8"	
<b>3-1/2" Hubs – BLB350-M, BLB350-A, BUB350-M and BUB350-A</b>						<b>4" Hubs – BLB400-M, BLB400-A, BUB400-M and BUB400-A</b>					
4	47	21"	21"	2"	8"	60	24"	24"	2"	10"	
3	39	21"	21"	2"	8"	51	24"	24"	2"	10"	
2	33	21"	21"	2-1/2"	8"	43	24"	24"	2-1/2"	10"	
1	25	21"	21"	3"	8"	32	24"	24"	3"	10"	
0	21	21"	21"	3-1/2"	8"	27	24"	24"	3-1/2"	10"	
0	17	21"	21"	3-1/2"	8"	22	24"	24"	3-1/2"	10"	
0	14	21"	21"	4"	8"	18	24"	24"	4"	10"	
0	12	21"	21"	4"	8"	15	24"	24"	4"	10"	
250	10	21"	21"	4-1/2"	8"	12	24"	24"	4-1/2"	10"	
300	8	21"	21"	5"	8"	11	24"	24"	5"	10"	
350	7	21"	21"	5"	8"	9	24"	24"	5"	10"	
400	6	21"	21"	6"	8"	8	24"	24"	6"	10"	
500	5	21"	21"	6"	8"	7	24"	24"	6"	10"	
600	4	21"	21"	8"	8"	5	24"	24"	8"	10"	
700	4	21"	21"	8"	8"	5	24"	24"	8"	10"	
750	3	21"	21"	8"	8"	4	24"	24"	8"	10"	
800	3	21"	21"	8"	8"	4	24"	24"	8"	10"	
900	3	21"	21"	8"	8"	4	24"	24"	8"	10"	
1000	-	-	-	-	-	3	24"	24"	10"	10"	

① NEC 370.28(A). Limited to minimum #4 wire.

② NEC Chapter 9, Table 3B.

③ NEC 370.28(A)(2) This is 6 times conduit trade size.

④ NEC 370.28(A)(2) Exception (312.6(B) Table). This is distance "A" bending space illustrated on preceding page.

# NEC 6x8x Series C, T, LL, LR Mogul Body Dimensions

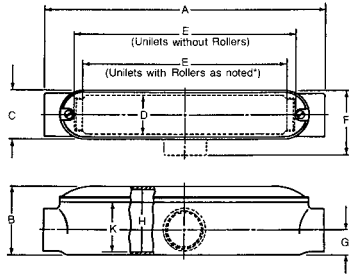

Types C, T

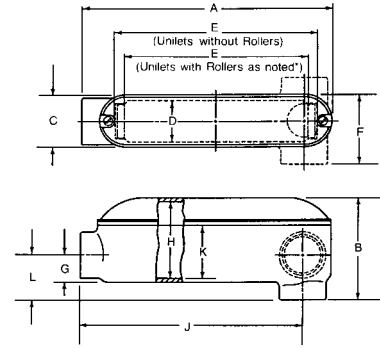

Types LB, LL, LR

Type Mogul	Hub Trade Size (Inches)	Dimensions in Millimeters (Inches)										Number of Cover Holes
		A	B	C	D	E	F	G	H	J	K	
C	1	249.2 (9.81)	69.9 (2.75)	60.5 (2.38)	47.8 (1.88)	168.4 (6.63)	-	23.9 (0.94)	62.0 (2.44)	-	47.8 (1.88)	2
	1-1/4 ①	304.8 (12.00)	84.1 (3.31)	60.5 (2.38)	47.8 (1.88)	195.3 (7.69)	-	29.5 (1.16)	76.2 (3.00)	-	55.6 (2.19)	2
	1-1/2 ①	354.1 (13.94)	95.3 (3.75)	79.5 (3.13)	63.5 (2.50)	236.5 (9.31)	-	35.1 (1.38)	85.9 (3.38)	-	65.0 (2.56)	2
	2 ①	455.7 (17.94)	112.8 (4.44)	79.5 (3.13)	63.5 (2.50)	330.2 (13.00)	-	41.4 (1.63)	101.6 (4.00)	-	80.8 (3.18)	2
	2-1/2 ①	590.6 (23.25)	130.3 (5.13)	117.6 (4.63)	95.3 (3.75)	444.5 (17.50)	-	46.0 (1.81)	117.6 (4.63)	-	92.2 (3.63)	4
	3 ①	682.8 (26.88)	150.9 (5.94)	117.6 (4.63)	92.2 (3.63)	533.4 (21.00)	-	54.9 (2.16)	138.2 (5.44)	-	111.3 (4.38)	4
	3-1/2 ①	797.1 (31.38)	182.6 (7.19)	143.0 (5.63)	114.3 (4.50)	633.5 (24.94)	-	63.5 (2.50)	169.9 (6.69)	-	124.0 (4.88)	4
	4 ①	898.7 (35.38)	192.0 (7.56)	143.0 (5.63)	114.3 (4.50)	735.1 (28.94)	-	69.9 (2.75)	179.3 (7.06)	-	133.4 (5.25)	4
T	1	249.2 (9.81)	69.9 (2.75)	60.5 (2.38)	47.8 (1.88)	168.4 (6.63)	82.6 (3.25)	23.9 (0.94)	62.0 (2.44)	-	47.8 (1.88)	2
	1-1/4	304.8 (12.00)	84.1 (3.31)	60.5 (2.38)	47.8 (1.88)	217.4 (8.56)	85.9 (3.38)	29.5 (1.16)	76.2 (3.00)	-	55.6 (2.19)	2
	1-1/2	354.1 (13.94)	95.3 (3.75)	79.5 (3.13)	63.5 (2.50)	263.7 (10.38)	104.9 (4.13)	35.1 (1.38)	85.9 (3.38)	-	65.0 (2.56)	2
	2	455.7 (17.94)	112.8 (4.44)	79.5 (3.13)	63.5 (2.50)	358.9 (14.13)	104.9 (4.13)	41.4 (1.63)	101.6 (4.00)	-	80.8 (3.18)	2
	2-1/2	590.6 (23.25)	130.3 (5.13)	117.6 (4.63)	95.3 (3.75)	474.7 (18.69)	152.4 (6.00)	46.0 (1.81)	117.6 (4.63)	-	92.2 (3.63)	4
	3	682.8 (26.88)	150.9 (5.94)	117.6 (4.63)	92.2 (3.63)	563.6 (22.19)	152.4 (6.00)	54.9 (2.16)	138.2 (5.44)	-	111.3 (4.38)	4
	3-1/2	797.1 (31.38)	182.6 (7.19)	143.0 (5.63)	114.3 (4.50)	665.2 (26.19)	184.2 (7.25)	63.5 (2.50)	169.9 (6.69)	-	124.0 (4.88)	4
	4	898.7 (35.38)	192.0 (7.56)	143.0 (5.63)	114.3 (4.50)	766.8 (30.19)	184.2 (7.25)	69.9 (2.75)	179.3 (7.06)	-	133.4 (5.25)	4
LL, LR	1	227.1 (8.94)	69.9 (2.75)	60.5 (2.38)	47.8 (1.88)	168.4 (6.63)	82.6 (3.25)	23.9 (0.94)	62.0 (2.44)	200.2 (7.88)	47.8 (1.88)	2
	1-1/4	246.1 (9.69)	84.1 (3.31)	60.5 (2.38)	47.8 (1.88)	184.2 (7.25)	85.9 (3.38)	29.5 (1.16)	76.2 (3.00)	215.9 (8.50)	55.6 (2.19)	2
	1-1/2	330.2 (13.00)	95.3 (3.75)	79.5 (3.13)	63.5 (2.50)	263.7 (10.38)	104.9 (4.13)	35.1 (1.38)	85.9 (3.38)	295.4 (11.63)	65.0 (2.56)	2
	2	371.6 (14.63)	127.0 (5.00)	79.5 (3.13)	63.5 (2.50)	300.0 (11.81)	104.9 (4.13)	41.4 (1.63)	115.8 (4.56)	328.7 (12.94)	87.4 (3.44)	2

① Furnished with rollers for easier cable pulling.



# NEC 6x8x Series LB, UB Mogul Body Dimensions

Fittings

NEC/CEC CONDUIT BODIES

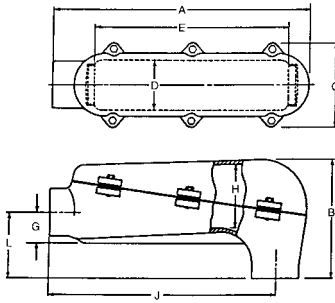

Type LB – 2-1/2" thru 4"

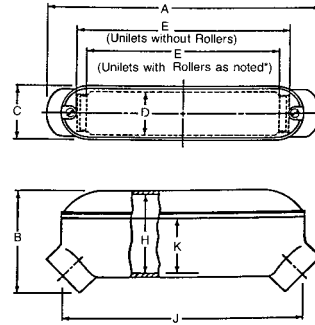

Type UB

Type Mogul	Hub Trade Size (Inches)	Dimensions in Millimeters (Inches)										Number of Cover Holes
		A	B	C	D	E	G	H	J	K	L	
LB	1	227.1 (8.94)	92.2 (3.63)	60.5 (2.38)	47.8 (1.88)	168.4 (6.63)	23.9 (0.94)	62.0 (2.44)	200.2 (7.88)	47.8 (1.88)	47.8 (1.88)	2
	1-1/4 ①	246.1 (9.69)	120.7 (4.75)	60.5 (2.38)	47.8 (1.88)	160.3 (6.31)	29.5 (1.16)	87.4 (3.44)	215.9 (8.50)	66.8 (2.63)	54.9 (2.16)	2
	1-1/2 ①	330.2 (13.00)	133.4 (5.25)	79.5 (3.13)	63.5 (2.50)	236.5 (9.31)	35.1 (1.38)	100.1 (3.94)	295.4 (11.63)	77.7 (3.06)	60.5 (2.38)	2
	2 ①	371.6 (14.63)	160.3 (6.31)	79.5 (3.13)	63.5 (2.50)	273.1 (10.75)	41.4 (1.63)	124.0 (4.88)	328.7 (12.94)	87.4 (3.44)	68.3 (2.69)	2
	2-1/2 ①	454.2 (17.88)	203.2 (8.00)	149.4 (5.88)	88.9 (3.50)	349.3 (13.75)	54.1 (2.13)	104.9 (4.13)	401.6 (15.81)	-	115.8 (4.56)	6
	3 ①	534.9 (21.06)	254.0 (10.00)	149.4 (5.88)	88.9 (3.50)	431.8 (17.00)	63.5 (2.50)	130.3 (5.13)	469.9 (18.50)	-	136.7 (5.38)	6
	3-1/2 ①	617.5 (24.31)	260.4 (10.25)	177.8 (7.00)	117.6 (4.63)	505.0 (19.88)	76.2 (3.00)	120.7 (4.75)	543.1 (21.38)	-	168.4 (6.63)	6
	4 ①	698.5 (27.50)	317.5 (12.50)	177.8 (7.00)	117.6 (4.63)	584.2 (23.00)	82.6 (3.25)	162.1 (6.38)	619.3 (24.38)	-	177.8 (7.00)	6
UB	1	244.6 (9.63)	88.9 (3.50)	60.5 (2.38)	47.8 (1.88)	168.4 (6.63)	-	62.0 (2.44)	214.4 (8.44)	47.8 (1.88)	-	2
	1-1/4 ①	260.4 (10.25)	104.9 (4.13)	60.5 (2.38)	47.8 (1.88)	160.3 (6.31)	-	76.2 (3.00)	227.1 (8.94)	55.6 (2.19)	-	2
	1-1/2 ①	347.7 (13.69)	117.6 (4.63)	79.5 (3.13)	63.5 (2.50)	236.5 (9.31)	-	85.9 (3.38)	309.6 (12.19)	65.0 (2.56)	-	2
	2 ①	387.4 (15.25)	127.0 (5.00)	79.5 (3.13)	63.5 (2.50)	273.1 (10.75)	-	115.8 (4.56)	339.9 (13.38)	80.8 (3.18)	-	2
	2-1/2 ①	581.2 (22.88)	179.3 (7.06)	117.6 (4.63)	95.3 (3.75)	444.5 (17.50)	-	138.2 (5.44)	511.3 (20.13)	111.3 (4.38)	-	4
	3 ①	581.2 (22.88)	185.7 (7.31)	117.6 (4.63)	95.3 (3.75)	444.5 (17.50)	-	173.0 (6.81)	511.3 (20.13)	111.3 (4.38)	-	4
	3-1/2 ①	784.4 (30.88)	227.1 (8.94)	143.0 (5.63)	114.3 (4.50)	632.0 (24.88)	-	179.3 (7.06)	698.5 (27.50)	133.4 (5.25)	-	4
	4 ①	784.4 (30.88)	261.9 (10.31)	143.0 (5.63)	114.3 (4.50)	632.0 (24.88)	-	214.4 (8.44)	698.5 (27.50)	133.4 (5.25)	-	4

① Furnished with rollers for easier cable pulling.