

**READ AND KEEP THIS FOR FUTURE REFERENCE**

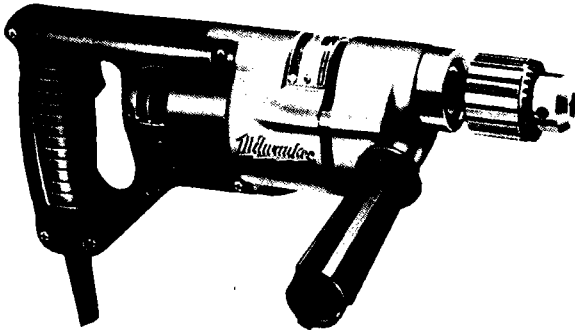

**CARE  
AND  
OPERATING  
INSTRUCTIONS**

**HEAVY-DUTY  
HOLE-SHOOTERS**



**D-HANDLE HOLE-SHOOTERS**

CAT. NO.	CAT. NO.
0801	1101
0871	1101-1 Rev.
1001	1101-3 Rev. (240V)
1001-1 Rev.	1201-1 Rev.
	1250-1 Rev.

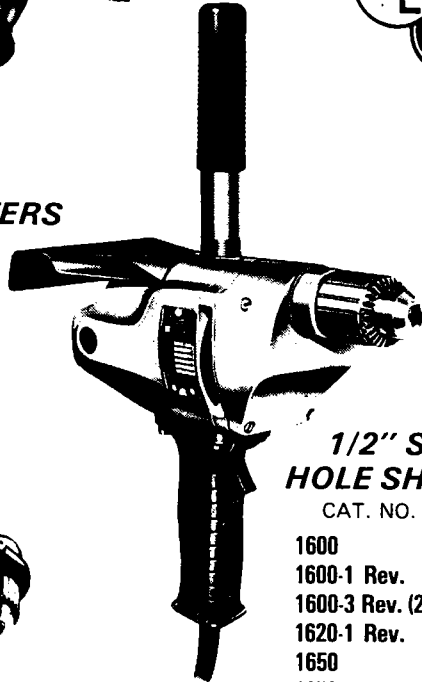

**1/2" SUPER  
HOLE SHOOTERS**

CAT. NO.

- 1600
- 1600-1 Rev.
- 1600-3 Rev. (240V)
- 1620-1 Rev.
- 1650
- 1650-1 Rev.
- 1650-3 Rev. (240V)

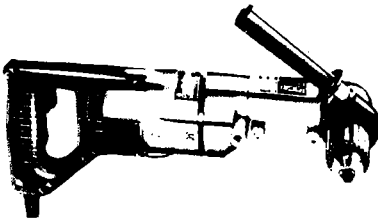

**RIGHT ANGLE DRIVE UNITS  
AND RIGHT ANGLE DRILL KITS**

Powered by D-Handle Drills Listed Above

**IMPORTANT**—Before placing tool in operation, record the following information from nameplate.

Catalog No. \_\_\_\_\_ Serial Number \_\_\_\_\_ Date of Purchase \_\_\_\_\_

**MILWAUKEE ELECTRIC TOOL CORPORATION**

13135 West Lisbon Road • Brookfield, Wisconsin 53005

THIS SYMBOL ...



... IS YOUR ASSURANCE

1. That every tool manufactured by MILWAUKEE is produced in accordance with applicable Standards for Safety of Underwriters' Laboratories and American National Standards (ANSI).
2. That compliance with applicable safety standards is assured by independent inspection and testing conducted by Underwriters' Laboratories (UL).
3. That every motorized tool manufactured by MILWAUKEE is fully inspected.
4. That every tool has with it adequate instructions and a list of safety rules for the protection of the user.

**WARNING:** When using electric tools, basic safety precautions should always be followed to reduce the risk of fire, electric shock and personal injury including the following items. Read all instructions and save them for future reference.

### SAFETY INSTRUCTIONS FOR ALL POWER TOOLS

1. **KNOW YOUR POWER TOOL.** Read owner's manual carefully. Learn its applications and limitations as well as the specific potential hazards peculiar to this tool.
2. **GROUND ALL TOOLS—UNLESS DOUBLE-INSULATED.** If the tool is equipped with a three prong plug, it should be plugged into a three hole electrical receptacle. If an adapter is used to accommodate a two hole receptacle, the grounding ear must be attached to a known ground. Never remove the third prong.
3. **KEEP GUARDS IN PLACE** and in working order.
4. **KEEP WORK AREA CLEAN.** Cluttered areas and benches invite accidents.
5. **AVOID DANGEROUS ENVIRONMENTS.** Don't expose power tools to rain or use in damp or wet locations. Do not use tool in presence of flammable liquids or gases. Keep the work area well lit.
6. **KEEP CHILDREN AWAY.** All visitors should be kept a safe distance from the work area. Do not let visitors contact tool or extension cords.
7. **STORE IDLE TOOLS.** When not in use, tools should be stored in a dry, high or locked-up place—out of reach of children.
8. **DON'T FORCE TOOL.** It will do the job better and safer at the rate for which it was designed.
9. **USE RIGHT TOOL.** Don't force a small tool or attachment to do the job of a heavy-duty tool. Don't use a tool for a purpose it was not designed for, such as using a circular saw for cutting tree limbs or logs.
10. **WEAR PROPER APPAREL.** No loose clothing or jewelry to get caught in moving parts. Rubber gloves and insulated non-skid footwear are recommended when working outdoors. Wear protective covering to contain long hair.
11. **USE SAFETY GLASSES** at all times. Also, use a face or dust mask if cutting operation is dusty.
12. **DON'T ABUSE CORD.** Never carry the tool by its cord or yank it to disconnect from the receptacle. Keep cord from heat, oil and sharp edges.
13. **SECURE WORK.** Use clamps or a vise to hold work. It's safer than using your hand and it frees both hands to operate tool.
14. **DON'T OVERREACH.** Keep proper footing and balance at all times.
15. **DISCONNECT TOOLS.** When not in use; before servicing; when changing accessories such as blades, bits, cutters, etc.
16. **GUARD AGAINST ELECTRIC SHOCK.** Prevent body contact with grounded surfaces such as pipes, radiators, ranges and refrigerator enclosures.
17. **REMOVE ADJUSTING KEYS AND WRENCHES.** Form a habit of checking to see that keys and adjusting wrenches are removed from tool before turning it on.

18. **MAINTAIN TOOLS WITH CARE.** Keep tools sharp and clean at all times for best and safest performance. Follow instructions for lubricating and changing accessories. Keep handles dry, clean and free of oil or grease. Inspect switches, tool cords and extension cords periodically and have them repaired or replaced by an authorized service facility if damaged. Check moving parts for alignment and binding as well as for breakage and improper mounting. Damaged parts should be repaired or replaced by an authorized service facility unless otherwise indicated in this instruction book. **CAUTION:** Do not use carbon tetrachloride.
19. **AVOID ACCIDENTAL STARTING.** Don't carry a plugged-in tool with your finger on the switch. Be sure the switch is turned off before plugging in a tool. Do not use a tool if the switch does not turn it on or off.
20. **WEAR EAR PROTECTORS** when using for extended periods.
21. **ACCESSORIES.** The use of any accessories other than what is listed or recommended for this particular tool may be hazardous.
22. **KEEP HANDS AWAY FROM CUTTING EDGES AND ALL MOVING PARTS.**
23. **USE INSULATED SURFACES.** A double-insulated or grounded tool may be made live if the blade or bit comes in contact with live wiring in a wall, floor, ceiling, etc. Always check the work area for live wires and hold the tool by the insulated surfaces when making "blind" or plunge cuts.
24. **GRINDING WHEELS.** Use only grinding wheels with "Safe Speed" at least as high as the no load RPM" marked on the nameplate.
25. **USE SIDE HANDLES** when supplied with tool for control and safety.
26. **STAY ALERT.** Watch what you are doing and use common sense. Do not operate tool when you are tired.

## GROUNDING INSTRUCTIONS

This tool should be grounded while in use to protect the user from electric shock. The tool is equipped with an approved three conductor cord and three prong grounding-type plug to fit the proper grounding-type receptacle. The green conductor in the cord is the grounding wire. Never connect the green wire to a live terminal. If your unit is for use on less than 150 volts, it has a plug that looks like figure "A". If it is for use on 150 to 250 volts, it has a plug that looks like figure "C".

### NOTE

The use of three-prong adapters in Canada is prohibited by the Canadian Electrical Code.

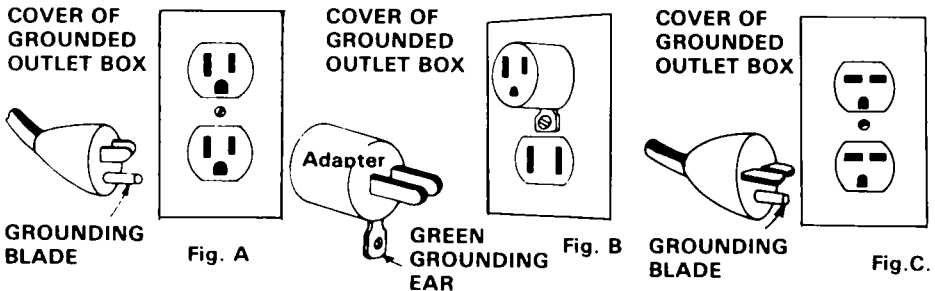

An adapter, Figure "B", is available for connecting Figure "A" type plugs to two prong receptacles. The green grounding ear or wire extending from the adapter must be connected to a permanent ground such as a properly grounded outlet box. No adapter is available for Figure "C" type plugs.

**NOTE:** THE RECEPTACLE MUST BE GROUNDED FOR SAFE USE OF ADAPTER; IF IN DOUBT, CALL A QUALIFIED ELECTRICIAN AND HAVE THE RECEPTACLE CHECKED FOR GROUND.

## EXTENSION CORD CHART

When an extension cord is used, it should be a three wire cord to permit proper grounding of the tool. As the distance from the supply outlet increases, heavier gauge extensions are required. The use of extension cords of inadequate size wire causes a serious drop in voltage, loss of power and possible motor damage. This table is based on limiting the line voltage drop to five volts at 150% of rated amperes.

Ampere rating (on Nameplate)	0- 2.00	2.10- 3.4	3.5- 5.00	5.10- 7.0	7.10- 12.0	12.1- 16.0	16.1- 20.0	
Ext. Cable Length	Wire Size							
25 Ft.	18	18	18	18	16	14	12	Not normally available as flexible extension cord.
50 Ft.	18	18	18	16	14	12	10	
75 Ft.	18	18	16	14	12	10	8	
100 Ft.	18	16	14	12	10	8	8	
150 Ft.	16	14	12	12	8	8	6	
200 Ft.	16	14	12	10	8	6	4	
300 Ft.	14	12	10	8	6	4	4	
400 Ft.	12	10	8	6	4	4	2	
500 Ft.	12	10	8	6	4	2	2	
600 Ft.	10	8	6	4	2	2	1	
800 Ft.	10	8	6	4	2	1	0	
1000 Ft.	8	6	4	2	1	0	0	

IF USING AN EXTENSION CORD OUTDOORS, BE SURE IT IS MARKED WITH THE SUFFIX "W-A" ("W" IN CANADA) TO INDICATE THAT IT IS ACCEPTABLE FOR OUTDOOR USE.

**CAUTION:** Applications which could cause this tool to be driven at speeds more than 25% in excess of its rated speed are potentially dangerous and constitute misuse. This includes the use of voltage boosters. To prevent personal injury and damage to the tool, do not use this tool to start or drive small engines or other rotating machinery unless specifically recommended in this manual. The Milwaukee Electric Tool Corporation assumes no responsibility for damage or accidents resulting from the misuse of this tool, its misapplication or nonadherence to precautionary safety measures.

### Read All Instructions And Save Them For Future Reference

#### TO INSERT DRILL BITS

These MILWAUKEE Hole-Shooters are equipped with industrial, key type, geared chucks. When inserting bit, open chuck jaws wide enough to allow the bit to strike the bottom of the chuck. Be sure the shank of the bit and the chuck jaws are clean. Dirt particles may cause the bit to line up improperly. Tighten jaws by hand to align bit before tightening with chuck key. Never use a wrench or means other than the chuck key to tighten or loosen the chuck. Do not use bits which are larger than the rated capacity of the Drill. Gear damage or motor overload may result. For maximum drilling performance, be sure bits are properly sharpened before using.

#### OPERATION

Before drilling, clamp material down securely. A poorly secured piece of material may result in inaccurate drilling or personal injury if the bit should bind. When drilling holes in light gauge metal or wood, back up the material with a wooden block to prevent bending, distorting or splintering.

Mark the center of the hole to be drilled with a center punch to give the bit a start and to prevent it from "wandering". Place the drill on the center mark while in the "off" position. Holding the drill firmly at a 90° angle to the work, start motor and apply steady pressure. Do not use the trigger switch lock button in situations where the bit may bind making it necessary to stop the drill suddenly. Lubricate the drill with cutting oil when drilling iron or steel. Use a coolant when drilling non-ferrous metals such as copper, brass or aluminum.

## REVERSING MOTORS

Hole-Shooter Models . . . 1001-1, 1101-1, 1201-1, 1250-1, 1600-1, 1600-3, 1620-1, 1650-1 and 1650-3 are equipped with reversing motors. Allow motor to come to a complete stop before reversing. Reversing with motor and gears in motion may cause serious damage.

## AUXILIARY SIDE HANDLE

An Auxiliary Side Handle which screws into either side of the gear case is furnished with Hole-Shooter Models 0801 thru 1250-1. An additional handle is furnished with Right Angle Drive kits which clamps on the Bearing Cap of the Right Angle Drive Unit. When using Right Angle Drive do not use Hole-Shooter side handle on gear case. Models 1600 thru 1650-3 are furnished with an auxiliary Pipe Handle which screws into the motor housing. Always use Side Handle or Pipe Handle to maintain safe control.

## MAINTENANCE

All servicing other than recommended in this instruction manual must be done by a MILWAUKEE Service Center or Authorized Service Station.

## CHUCK REMOVAL

**Non-Reversing Drills** To remove the chuck from MILWAUKEE Hole-Shooters with non-reversing motors, hold the tool so that **only** the chuck rests firmly and squarely on the edge of a solid bench. Insert the chuck key or a chuck remover bar in a keyhole of the chuck. Turn the chuck until the key is at about a 30° angle to the bench top and strike the key sharply with a hammer so the chuck turns in the direction the chuck turns when operated in a forward position. This should free the chuck from the threaded spindle (right hand thread) and you will be able to remove it by hand.

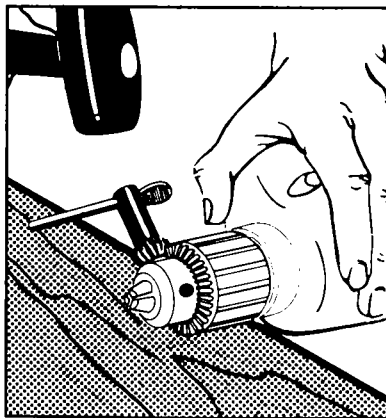

**Reversing Drills** To remove the chuck from MILWAUKEE Hole-Shooters, open the jaws of the chuck as far as possible and turn out the left hand thread socket head screw. This screw locks the chuck to the spindle. Once screw has been removed, the chuck may be taken off as described in the above copy for Non-Reversing Drills.

## LUBRICATON

All MILWAUKEE Hole-Shooters are lubricated at the factory and require additional lubricaton only at intervals of 6 months to 1 year depending upon the amount of use. When further lubrication is necessary, care should be taken to prevent the armature from coming loose when the gear case is removed. To remove gear case, remove the screws from the front of the case. Holding the tool on the diaphragm, lightly tap the gear case to loosen it. If the gear case will not completely dislodge, set the complete tool on a workbench and use two screwdrivers opposite each other to gently pry it off. If the diaphragm pulls free of the motor housing, the armature may be pulled out of the back bearing, possibly permitting the brushes to slip off the commutator. Should this occur, return the entire tool to the nearest Authorized MILWAUKEE Service Center or Authorized Service Station for reassembly. Return all parts.

Repack 2/3 full with MILWAUKEE Type "A" grease. 1/2 lb. Can, Cat. No. 49-08-0500. 1 lb. Can, Cat. No. 49-08-0800.

## BRUSHES AND COMMUTATOR

Failure of the motor to start or to operate efficiently can usually be attributed to worn or damaged brushes, brushes sticking in the holders and failing to make proper contact with the commutator, or to the commutator being dirty or rough. Frequent inspection of brushes and commutator is recommended.

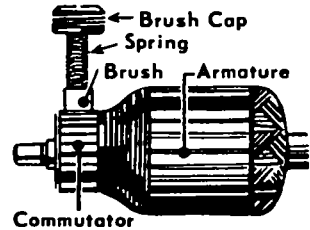

To inspect the brushes, remove plug from power source. Unscrew brush retainer caps located on motor housing. Pull out brush retainer springs and brushes.

Replace brushes when worn down to 1/4". Always replace both brushes at the same time. When inspecting brushes, also check the commutator for wear. If worn badly, send the complete tool to a MILWAUKEE Service Center or Authorized Service Station for undercutting and dressing of the commutator.

### USE ONLY IDENTICAL REPLACEMENT PARTS

Parts List Available On Request.

When ordering, include Catalog No. and Serial No. of Tool.

Write: MILWAUKEE ELECTRIC TOOL CORP. SERVICE DEPT.  
13135 W. Lisbon Rd. Brookfield, WI. 53005

## ACCESSORIES

See your MILWAUKEE catalog for a complete list of accessories.

## INSTRUCTIONS COVERING RIGHT ANGLE DRIVES

NO. 48-06-2871 REVERSING AND NO. 48-06-2870 NON-REVERSING

USED WITH "D" HANDLE DRILLS ILLUSTRATED ON FRONT COVER

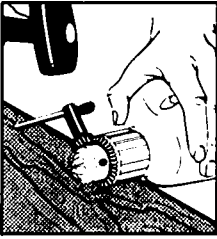

REST CHUCK ON SOLID SURFACE BEFORE REMOVING.  
FAILURE TO DO SO MAY RESULT IN A BENT SPINDLE.

### COUPLING

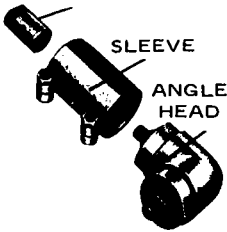

When removing chuck from reversing drills it is necessary to first remove the (l.h.) threaded socket screw as per instructions outlined in paragraph 5 on page 5 of this booklet.

To remove chuck from your drill for use with non-reversing "RAD" follow instructions outlined in paragraph 4 on page 5 of this booklet.

### ATTACHING RIGHT ANGLE DRIVE TO DRILL

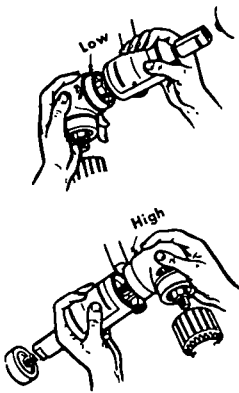

After removing chuck from drill, the double hex coupling should be slipped over the hex on the drill spindle. After mounting coupling, loosen the clamping screws on the clamping sleeve and slip the sleeve on to the collar of the drill. Slide Right Angle Drill head into the other end of the sleeve and turn the drive head slightly in either direction so the hexagon hole in the coupling engages the hexagon portion of the spindle. Attaching the drill chuck to the side designated "low" reduces the speed by 1/3 and increases torque 50%. Attaching the chuck to the opposite spindle increases the speed by 50%. When assembled, turn the Right Angle head to the desired position and tighten the clamping screws to secure the unit. Thread drill chuck on Right Angle spindle. **INSTALL CHUCK LOCKING SCREW ON REVERSING MODELS.**

### REMOVING CHUCK FROM "RAD" UNIT



Chuck can be removed from Right Angle Drive in the same manner it was removed from your drill; however, **ALWAYS REMOVE RIGHT ANGLE DRIVE FROM THE DRILL BEFORE ATTEMPTING TO LOOSEN CHUCK.** This will prevent damaging drills gearing. Use the open end wrench provided to hold Right Angle Drive Spindle before attempting to loosen chuck.

## HEAVY-DUTY TOOLS FOR CONTRACTORS AND INDUSTRY

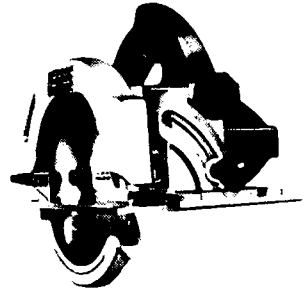
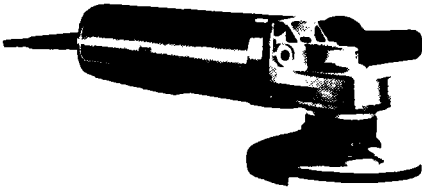

*Milwaukee*  
Amstar

### WARRANTY

Every MILWAUKEE Tool is thoroughly inspected and tested before leaving the factory. Should any trouble develop, return the complete tool prepaid to the Factory, Branch or nearest Authorized Service Station. If inspection shows the trouble is caused by defective workmanship or material, all repairs will be made without charge and the tool will be returned transportation prepaid.

This warranty does not apply where: (1) repairs or attempted repairs have been made by persons other than Factory, Branch or Authorized Service Station personnel; (2) repairs are required because of normal wear; (3) the tool has been misused or involved in an accident; (4) misuse is evident such as caused by overloading the tool beyond its rated capacity; (5) the tool has been used after partial failure or (6) the tool has been used with an improper accessory. No other warranty written or verbal, is authorized.

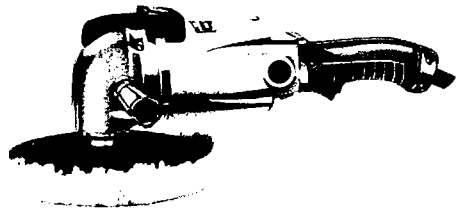
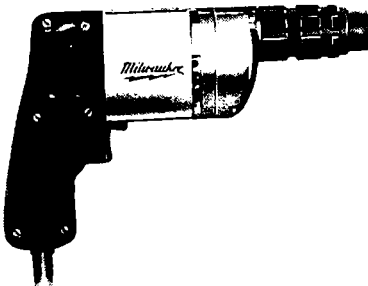

## MILWAUKEE ELECTRIC TOOL CORPORATION

13135 W. LISBON ROAD

BROOKFIELD, WISCONSIN 53005