

## Rack Power Distribution Solutions for IT & Network Environments

Power Commander® Power Distribution Units offer comprehensive power distribution solutions for IT environments from networking solutions to high density servers.

Power Commander® IQ Power Distribution Units offer remote current and temperature monitoring of connected equipment and individual outlet control for power recycling. Management of power up/down sequencing of equipment can all be done remotely. Our power distribution unit alarms warn IT personnel of potential power or environment problems before they become critical.

Power Commander® and Power Commander® Plus High Current Power Distribution Units provide an elegant solution where reliable high-density power distribution for IT equipment racks, cabinets, and enclosures is required.

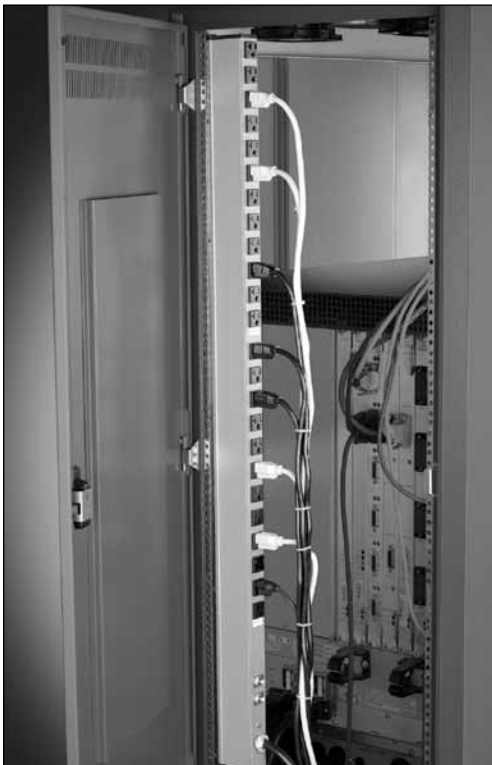

Power Commander High Current Power Distribution Unit shown mounted in an IT cabinet.

Power Commander Plus High Current Power Distribution Unit shown mounted in an IT cabinet.



Power Commander IQ Network Controlled Power Distribution Units.

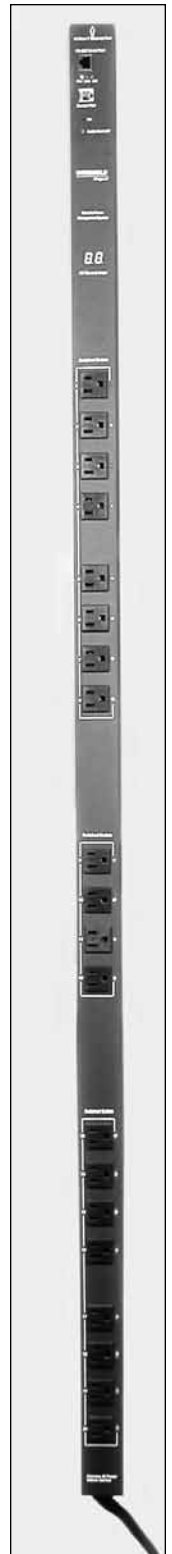

# Power Commander® IQ

Network Controlled  
Power Distribution Units

Keep up with the ever increasing management demands of your data center with **Wiremold®** Power Commander® IQ Network-Controlled Power Distribution Units (PDUs). These models offer secure remote access for all power outlets, giving users the flexibility they need to manage the ever increasing loads placed on IT infrastructure.

Available in 0U, 1U and 2U configurations, all models have current and temperature monitoring, critical in today's higher power density environments. cTUVus Listed to EN60950-1, ensuring safe and reliable distribution of power.

Designed to efficiently manage your valuable IT equipment used in cabinets and enclosures, the Power Commander® IQ Network-Controlled PDUs are the ideal solution for your growing data center.

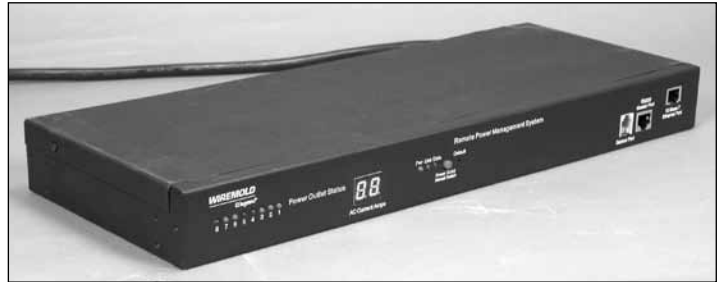
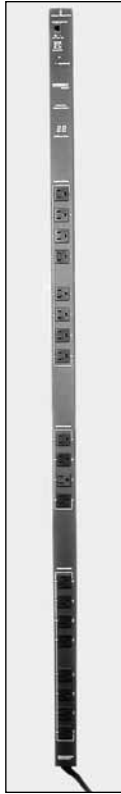

Power Commander IQ Network Controlled Power Distribution Units.

## FEATURES & BENEFITS

- **Remote access.** Access via HTTP web browser, Telnet, SNMP, external modem or email.
- **Unique email feature.** Allows user to send control commands via email (POP3/SMTP).
- **Convenient Access Control List (ACL).** For assigning access rights.
- **Network security.** Includes user name and password authentication (64-bit encryption) and IP screening for each outlet.
- **Embedded Web server.** Enables user to easily change settings, view or alter system status.
- **AutoPing feature.** Constantly monitors the IP address and executes a power reboot whenever the system is down.
- **Current (AC) and Temperature monitoring.** Via TCP/IP network or local direct connection. Temperature monitoring requires optional Temperature Sensor, Cat. No. PDU-TS1.
- **Monitoring includes settings for user defined alarm threshold.** Alarm methods include: Audio buzzer, email, TRAP or data log, and alarm message time interval.
- **Programmable.** Each outlet can be programmed to turn on/off per calendar and/or real-time clock.
- **Multiple network connections.** One RS232 Master Service port and one 10BASE-T RJ-45 Ethernet port.
- **Versatile.** Mounts easily to most industry standard cabinets and enclosures.
- **cTUVus.** Listed to EN60950-1.

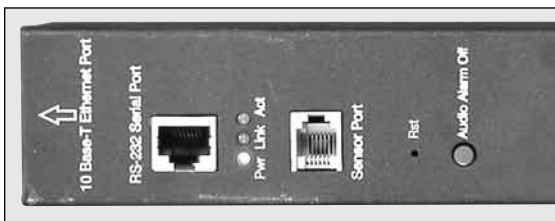

RS232/RJ45 ports facilitate network connectivity.



Ammeter provides visual monitoring capabilities.

## Specifications for SPDU20-0U

**Catalog No. SPDU20-0U**

Twenty (20) 15A simplex outlets. Black housing.

**Length:** 61" [1.5m]  
**Width:** 1 3/4" [44mm]  
**Depth:** 2 1/2" [60mm]

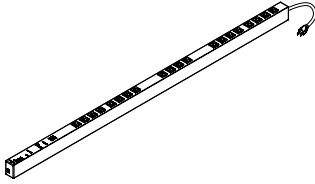

<b>AC Voltage Input:</b>	100 to 125V
<b>AC Voltage Output:</b>	100 to 125V
<b>Frequency:</b>	60 Hz
<b>Load Capacity:</b>	20A
<b>Output Receptacle:</b>	20 switched NEMA 5-15
<b>Product Warranty:</b>	2 years
<b>Power Cable – AWG Length &amp; Plug Type:</b>	12/3 SJT Type, L5-20P Locking plug, 9 1/2 ft. [2.9m]
<b>AC Current Draw Monitoring:</b>	Measurement of True RMS from all Circuits
<b>Console Interface – Local Master Port:</b>	1 RS232 Port. RJ-45 Connector Type. Data: 7 or 8 bits. Stop Bits: 1 or 2. Parity: None, Odd or Even. Flow Control: None or RTS/CTS. Baud rate 2400 to 115200.
<b>Audio Buzzer:</b>	85 Decibel
<b>Display:</b>	20 Power Outlet ON/OFF status LEDs, 1 Power On/Off LED. 2 Network LEDs. 2 digit LED display (1.00" x 0.65") [25mm x 16.5mm] for AC Current Draw Status.
<b>Temperature Sensing Port:</b>	Digital Input Port – RJ11
<b>Network Interface:</b>	10BASE-T RJ45.
<b>Network Protocols:</b>	ICMP, TCP/IP, DHCP, Telnet, DNS, POP3/SMTP, SNMP, HTTP, and BootP
<b>Weight:</b>	18 lbs. Shipping Weight
<b>Operational Temperature Environment:</b>	32F° – 122F° (0C° – 50C°)
<b>Storage Temperature:</b>	-20F° – 140F° (-29C° – 60C°)
<b>Humidity:</b>	10% – 90% RH

## Specifications for SPDU8-1U

**Catalog No. SPDU8-1U**

Eight (8) 15A simplex outlets. Black housing.

**Length:** 19" [1.5m]  
**Width:** 1 5/8" [41mm]  
**Depth:** 6 1/4" [159mm]

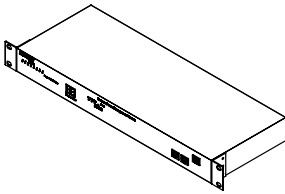

<b>AC Voltage Input:</b>	100 to 125V
<b>AC Voltage Output:</b>	100 to 125V
<b>Frequency:</b>	60 Hz
<b>Load Capacity:</b>	15A
<b>Output Receptacle:</b>	8 switched NEMA 5-15
<b>Product Warranty:</b>	2 years
<b>Power Cable – AWG Length &amp; Plug Type:</b>	14/3 SJT Type, 5-15P straight blade, 4 1/2 ft. [1.4m]
<b>Console Interface – Local Master Port:</b>	1 RS232 Port. RJ-45 Connector. Data: 7 or 8 bits. Stop Bits: 1 or 2. Parity: None, Odd or Even. Flow Control: None or RTS/CTS. Baud rate 2400 to 115200.
<b>Temperature Sensing Port:</b>	Digital Input Port – RJ11
<b>Network Interface:</b>	10BASE-T RJ45.
<b>Display:</b>	8 Power Outlet On/Off status LEDs, 2 Network LEDs. 2 digit LED display (1.00" x 0.65") [25mm x 16.5mm] for AC Current Draw Status.
<b>Network Protocols:</b>	ICMP, TCP/IP, DHCP, Telnet, DNS, POP3/SMTP, SNMP, HTTPS/HTTP, and BootP
<b>Weight:</b>	7 lbs. Shipping Weight
<b>Operational Temperature Environment:</b>	32F° – 122F° (0C° – 50C°)
<b>Storage Temperature:</b>	-20F° – 140F° (-29C° – 60C°)
<b>Humidity:</b>	10% – 90% RH

## Specifications for SPDU16-2U

### Catalog No. SPDU16-2U

Sixteen (16) 15A simplex outlets in two banks of 8. Black housing.

**Length:** 19" [1.5m]  
**Width:** 3 7/32" [82mm]  
**Depth:** 6 1/4" [159mm]

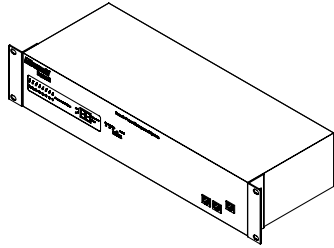

<b>AC Voltage Input:</b>	100 to 125V
<b>AC Voltage Output:</b>	100 to 125V
<b>Frequency:</b>	60 Hz
<b>Load Capacity:</b>	30A (2 circuits, 15A each)
<b>Output Receptacle:</b>	16 Pcs switched NEMA 5-15 (8 pieces each circuit)
<b>Product Warranty:</b>	2 years
<b>Power Cable – AWG Length &amp; Plug Type:</b>	2 power cables, 14/3 SJT Type, 5-15P straight blade, 4 1/2 ft. [1.4m]
<b>Console Interface – Local Master Port:</b>	1 RS232 Port. RJ-45 Connector. Data: 7 or 8 bits. Stop Bits: 1 or 2. Parity: None, Odd or Even. Flow Control: None or RTS/CTS. Baud rate 2400 to 115200.
<b>Temperature Sensing Port:</b>	Digital Input Port – RJ11
<b>Network Interface:</b>	10BASE-T RJ45.
<b>Display:</b>	16 Power Outlet On/Off status LEDs, 2 Network LEDs. 2 digit LED display (1.00" x 0.65") [25mm x 16.5mm] for AC Current Draw Status.
<b>Network Protocols:</b>	ICMP, TCP/IP, DHCP, Telnet, DNS, POP3/SMTP, SNMP, HTTPS/HTTP, and BootP
<b>Weight:</b>	10 lbs. Shipping Weight
<b>Operational Temperature Environment:</b>	32F° – 122F° (0C° – 50C°)
<b>Storage Temperature:</b>	-20F° – 140F° (-29C° – 60C°)
<b>Humidity:</b>	10% – 90% RH

## Mounting Options for SPDU20-0U

The Power Commander® IQ offers three convenient hardware options to mount the SPDU20-0U into racks and cabinets available from most major manufacturers.

### “L” BRACKET MOUNT (INCLUDED)

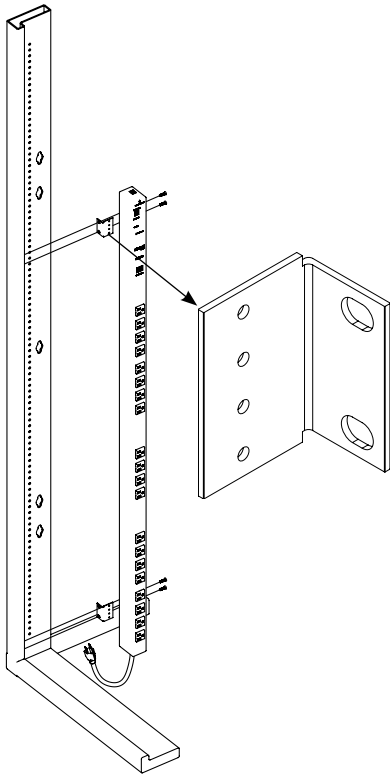

The “L” Bracket mounting option provides a simple and secure mounting solution for the SPDU20-0U.

### BUTTON BRACKET MOUNT (INCLUDED)

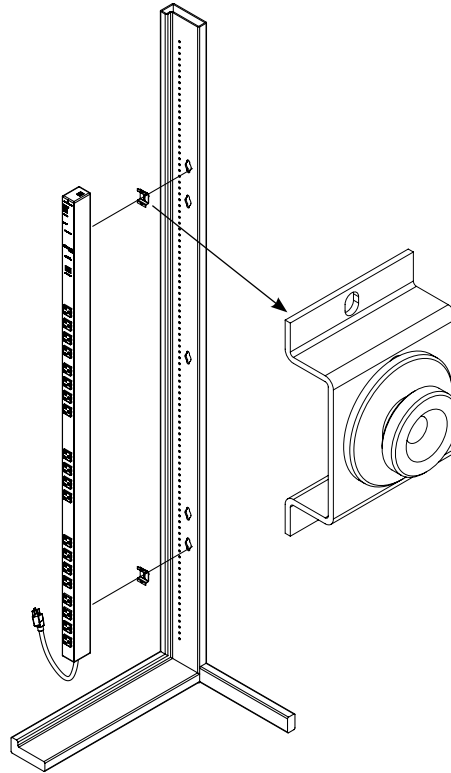

The button bracket mounting option offers a fast solution for mounting the SPDU20-0U using standard 49" [1.245m] spacing keyholes.

### UNI-BRACKET MOUNT – PDU-MK1 KIT ORDERED SEPARATELY

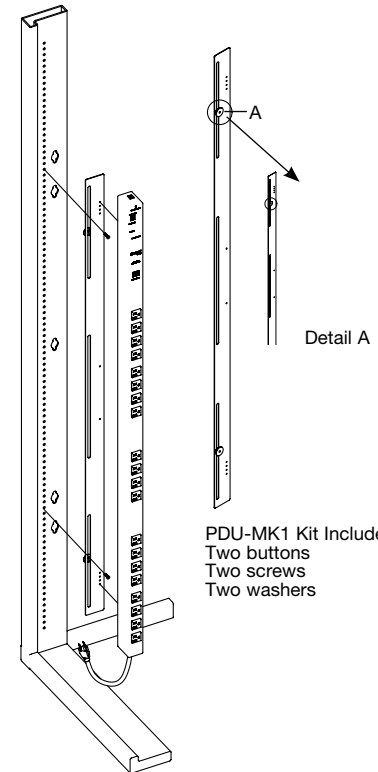

The PDU-MK1 Kit will allow you to mount the SPDU20-0U into racks and cabinets available from most major manufacturers.

# Power Commander® Plus

## High Current Power Distribution Units

Dealing with ever increasing power demands in your data racks? The new **Wiremold®** Power Commander® Plus Power Distribution Units will meet the challenge. Available in 120V 1-phase and 120/208V 3-phase configurations, the new Power Commander Plus PDUs have the capacity you need for your ever-growing power needs in you data center. Wiremold Power Commander Plus Power Distribution Units are Listed by TUV Rheinland and meet UL60950-1.



**6B21N Power Commander Plus Power Distribution Unit shown mounted in an IT cabinet.**

### FEATURES & BENEFITS

- **60 Amp Power Distribution.** High current 120V and 120/208V units allow you to safely support power-hungry IT equipment.
- **3-circuit design.** Each unit has 3 circuit breakers for overload protection. 60 Amp units have a 5-wire, 30A, 3-phase plug (3 Hots, 1 Neutral, 1 Ground) that is connected to three (3) 20 Amps circuits, giving you 60 Amps total.
- **UL489 Circuit Breakers.** All models use UL489 Listed circuit breakers that are more reliable than simple thermal protectors.
- **IEC Receptacles.** Models with IEC receptacles use both C13 and C19 receptacles for each circuit, offering maximum flexibility for powering IT equipment.
- **Easy swivel mounting.** Allows no-hassle one-handed mounting of the PDU, reducing installation time.
- **Choice of output receptacles.** Either NEMA or IEC output receptacles to match your existing power cabling.
- **Blue LED Power Indication for each circuit.** Provides confirmation at a glance that the circuit is powered.
- **Choice of colors for top enclosure.** Each model is available with either a black cover or white cover, allowing the user to easily identify primary and secondary power in redundant power schemes.
- **Listed.** Meets UL60950-1 Safety Standards.



**Hub assembly of a Power Commander Plus PDU showing circuit breakers and LEDs.**

**C13 Receptacle (Rated 15A)**



**C19 Receptacle (Rated 20A)**



## Specifications for 60 Amp Units: 120/208V System, 120V Output

<b>AC Voltage Input:</b>	120/208V
<b>AC Voltage Output:</b>	100 to 127V
<b>Frequency:</b>	60 Hz
<b>Load Capacity:</b>	30 Amps 3-phase, derated to 24 Amps: 3 – 20 Amp Circuits derated to 16 Amps (Circuits 1, 2 & 3)
<b>Circuit Breaker:</b>	3 – 20 Amp (Circuits 1, 2 & 3), UL489 Listed
<b>Output Receptacles:</b>	NEMA 5-20R, IEC C13 or IEC C19
<b>Product Warranty:</b>	2 years
<b>Power Cord:</b>	10/5 SOOW Type, L21-30P Plug, 10' [3.05m]

## 60A Power Commander Plus Power Distribution Units

### Catalog Nos. 6B21N, 6W21N

Eight (8) 5-20R outlets per circuit, twenty-four (24) total outlets. Black (6B) or White (6W) top cover.

- Length:** 64.12" [1.63m] overall,  
67.12" [1.70m] with mounting ears.
- Hub Length:** 10.12" [257mm]
- Width:** 2.00" [50.8mm]
- Depth:** 1.95" [49.5mm],  
3.20" [81.3mm] with hub
- Mounting:** 66.0" [1.68m] center-to-center

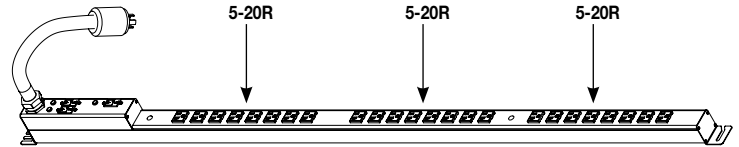

### Catalog Nos. 6B21E, 6W21E

Two (2) C19 outlets per circuit, eight (8) C13 outlets per circuit. Black (6B) or White (6W) top cover.

- Length:** 64.12" [1.63m] overall,  
67.12" [1.70m] with mounting ears.
- Hub Length:** 10.12" [257mm]
- Width:** 2.00" [50.8mm]
- Depth:** 1.95" [49.5mm],  
3.20" [81.3mm] with hub
- Mounting:** 66.0" [1.68m] center-to-center

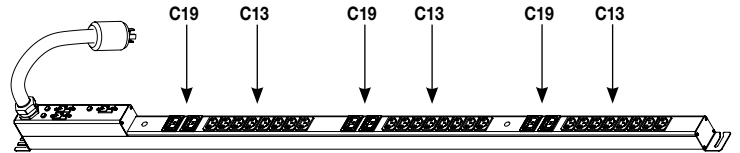

## Specifications for 60 Amp Units: 120/208V System, 208V Output

<b>AC Voltage Input:</b>	120/208V
<b>AC Voltage Output:</b>	200 to 230V
<b>Frequency:</b>	60 Hz
<b>Load Capacity:</b>	30 Amps 3-phase, derated to 24 Amps: 3 – 20 Amp Circuits derated to 16 Amps (Circuits 1, 2 & 3)
<b>Circuit Breaker:</b>	3 – 20 Amp (Circuits 1, 2 & 3), UL489 Listed
<b>Output Receptacles:</b>	IEC C13 or IEC C19
<b>Product Warranty:</b>	2 years
<b>Power Cord:</b>	10/5 SOOW Type, L21-30P Plug, 10' [3.05m]

## 60A Power Commander Plus Power Distribution Units

### Catalog Nos. 6B22E, 6W22E

Two (2) C19 outlets per circuit, eight (8) C13 outlets per circuit. Black (6B) or White (6W) top cover.

- Length:** 64.12" [1.63m] overall,  
67.12" [1.70m] with mounting ears.
- Hub Length:** 14.12" [359mm]
- Width:** 2.00" [50.8mm]
- Depth:** 1.95" [49.5mm],  
3.20" [81.3mm] with hub
- Mounting:** 66.0" [1.68m] center-to-center

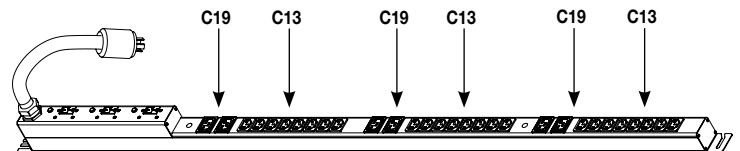

# Power Commander®

## High Current Power Distribution Units

Increase your IT closet's potential with a **Wiremold®** Power Commander® Power Distribution Unit (PDU). The dual circuit design allows you to safely draw a total of 30 or 40 Amps per unit, doubling your capacity from the 15A and 20A models.

Among the first in the industry to meet the **new UL60950-1 1st Edition** and ITE standards, the Power Commander PDU features UL489 Listed breakers to increase the safety and reliability of distributed power. Upgrade to units containing embedded or remote ammeters to maximize current draw and locally monitor current fluctuations.

Designed to support your valuable IT equipment used in cabinets and enclosures, the Power Commander PDU is the ideal solution to ever-expanding power needs in a confined space.

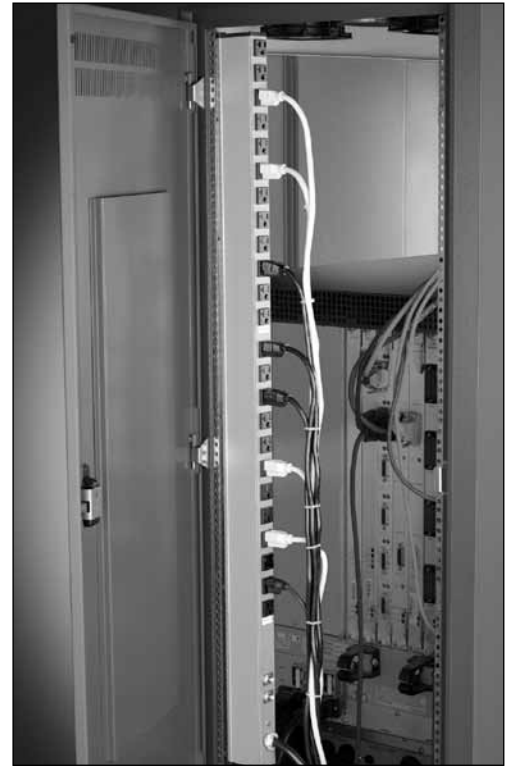

3A44B2-1 Power Commander Power Distribution Unit shown mounted in an IT cabinet.

### FEATURES & BENEFITS

- **30 Amp or 40 Amp Power Distribution.** High amperage 120V and 208V units allow you to safely support power-thirsty IT equipment.
- **Dual circuit design.** Two easy access circuit breakers provide overload protection. 30 Amp units use a 3-wire 30A plug (1 Hot, 1 Neutral, 1 Ground) that branches into two (2) 15 Amp circuits, giving you 30 Amps total. 40 Amp units use a 4-wire 20A plug (2 Hots, 1 Neutral, 1 Ground) that provides two (2) 20 Amp circuits, giving you 40 Amps total.
- **Built in universal slide mounting rail.** T-slot mounting rail allows several mounting options in tight spaces.
- **Current Monitoring.** -AM and -RAM units provide per circuit digital ammeter readouts (embedded or remote display). Ammetering allows you to evenly distribute power loads to maximize current draw and avoid circuit overloads.
- **Aesthetic narrow aluminum profile.** Now available in black, the streamlined housing saves valuable space.
- **Printed Circuit Board (PCB) Connection of UL489 Breakers.** Creates highly reliable connections to reduce potential point of failure.
- **Extensive Custom Capabilities.** See 'Custom Options' on page 4.
- **UL US Listed.** One of the first to meet UL60950-1 1st Edition and ITE standards.



Embedded Ammeter from "-AM" models shown with digital display and backlight.

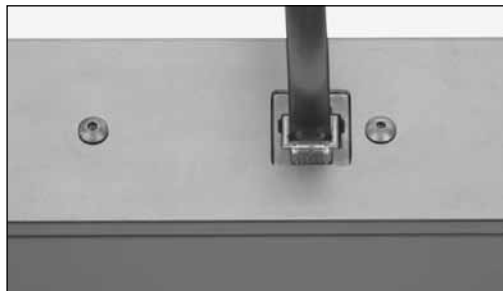

Remote Ammeter models "-RAM" connect to the digital display box via an included 7' [2.1m] RJ45 patch cable.

## Specifications for 30 Amp Units: 120V System

<b>AC Voltage Input:</b>	100 to 127V
<b>AC Voltage Output:</b>	100 to 127V
<b>Frequency:</b>	60 Hz
<b>Load Capacity:</b>	UL Rated 24Amps max – (2) 12 Amp circuits
<b>Circuit Breaker:</b>	(2) 15 Amp UL489 Listed circuit breakers
<b>Output Receptacle:</b>	NEMA 5-20R
<b>Product Warranty:</b>	2 years
<b>Power Cable – AWG Length &amp; Plug Type:</b>	10/3 SJT Type, L5-30P, 12ft. [3.6m]
<b>With Local Ammeter Readout:</b>	0-20 Amp 4-digit display +/- 0.2A LCD with backlighting
<b>With Remote Ammeter Readout:</b>	0-30A 3-digit display +/- 0.2A Remote LCD with backlighting

## 30A Power Commander Power Distribution Units

### Catalog No. 3A44B2-1 3B44B2-1

Twenty-four (24) 20A simplex outlets in two banks of 12. Gray (3A) or black (3B) housing.

**Length:** 48" [1.2m]  
**Width:** 1 1/2" [38mm]  
**Depth:** 2 7/8" [73mm]



### Catalog No. 3A86B2-1 3B86B2-1

Thirty-six (36) 20A simplex outlets in two banks of 18. Gray (3A) or black (3B) housing.

**Length:** 70" [1.8m]  
**Width:** 1 1/2" [38mm]  
**Depth:** 2 7/8" [73mm]



### Catalog No. 3B53B2-1-AM

Eighteen (18) 20A simplex outlets in two banks of 9. Two lighted LCD digital ammeters. Black housing.

**Length:** 54" [1.4m]  
**Width:** 1 1/2" [38mm]  
**Depth:** 2 7/8" [73mm]

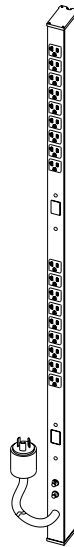

### Catalog No. 3B43B2-1-RAM

Eighteen (18) 20A simplex outlets in two banks of 9. Two lighted remote LCD ammeters. Black housing.

**Length:** 48" [1.2m]  
**Width:** 1 1/2" [38mm]  
**Depth:** 2 7/8" [73mm]



All "-RAM" units include two 7' [1.2m] patch cables, two remote displays, and a 1U rack-mountable faceplate for seamless and aesthetic integration into your IT environment.

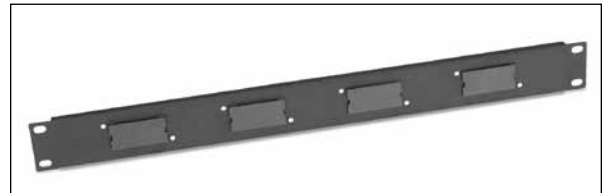



## Specifications for 40 Amp Units 208V-120V

<b>AC Voltage Input:</b>	200 to 230V
<b>AC Voltage Output:</b>	100 to 115V
<b>Frequency:</b>	60 Hz
<b>Load Capacity:</b>	UL Rated 32Amps max – (2) 16 Amp circuits
<b>Circuit Breaker:</b>	(2) 20 Amp UL489 Listed circuit breakers
<b>Output Receptacle:</b>	NEMA 5-20R
<b>Product Warranty:</b>	2 years
<b>Power Cable – AWG Length &amp; Plug Type:</b>	12/4 SJT Type, L14-20P, 12ft. [3.6m]
<b>With Local Ammeter Readout:</b>	0-20 Amp 4-digit display +/- 0.2A LCD with backlighting
<b>With Remote Ammeter Readout:</b>	0-30A 3-digit display +/- 0.2A Remote LCD with backlighting

## 40A Power Commander Power Distribution Units

### Catalog No. 4B44B2-2

Twenty-four (24) 20A simplex outlets in two banks of 12. Black housing.

**Length:** 48" [1.2m]  
**Width:** 1 1/2" [38mm]  
**Depth:** 2 7/8" [73mm]

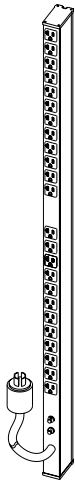

### Catalog No. 4B86B2-2

Thirty-six (36) 20A simplex outlets in two banks of 18. Black housing.

**Length:** 70" [1.8m]  
**Width:** 1 1/2" [38mm]  
**Depth:** 2 7/8" [73mm]



### Catalog No. 4B53B2-2-AM

Eighteen (18) 20A simplex outlets in two banks of 9. Two lighted LCD digital ammeters. Black housing.

**Length:** 54" [1.4m]  
**Width:** 1 1/2" [38mm]  
**Depth:** 2 7/8" [73mm]

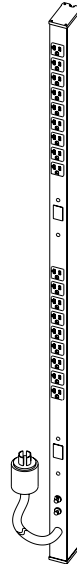

### Catalog No. 4B43B2-2-RAM

Eighteen (18) 20A simplex outlets in two banks of 9. Two lighted remote LCD ammeters. Black housing.

**Length:** 48" [1.2m]  
**Width:** 1 1/2" [38mm]  
**Depth:** 2 7/8" [73mm]



1U rack-mountable faceplate with loaded remote displays shown integrated in an IT rack or cabinet application. (Faceplate included in "-RAM" models only.)



## Standard Hardware Installation

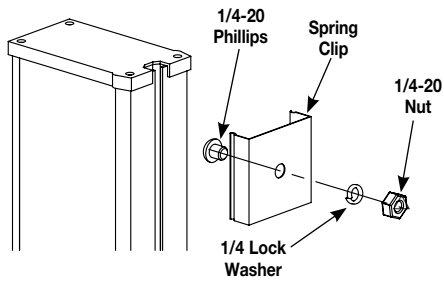

### Cat. No. BRK00329BULK

Attach the Spring Clips to the cabinet frame or cabinet wall making sure the top clip is no more than 1 inch [25mm] from the top of the unit. Insert the 1/4 - 20 Phillips screw through the spring clip as shown, and then through the cabinet frame or cabinet wall. On the other side of the mounting surface, put the 1/4 lock washer over the exposed Phillips screw and tighten into place with the 1/4 - 20 nut. Once the spring clips are secure, place unit in one side of the clips and snap the other side into position.

## Mounting Accessories

Understanding that each cabinet, enclosure, rack and application is unique, Wiremold has designed four solutions for mounting the 30 Amp Power Distribution Units using the universal T-slot built into the unit. The mounting kits listed below are available for purchase as accessories.

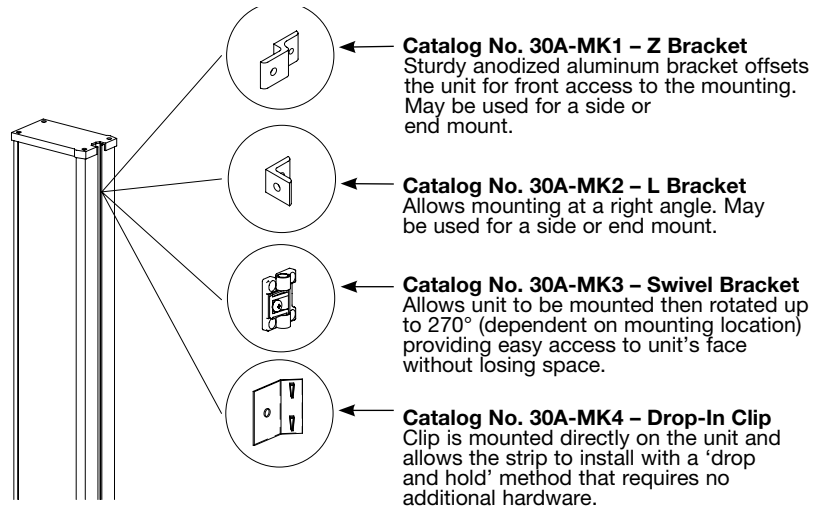

**NOTE: Accessory mounting kits are not UL Listed.**





**Electrical Wiring Systems**

60 Woodlawn Street  
West Hartford, CT 06110  
Phone: 1.877.BY.LEGRAND (295-3472)  
[www.legrand.us](http://www.legrand.us)

570 Applewood Crescent  
Vaughan, Ontario L4K 4B4  
Phone: 905.738.9195  
[www.legrand.ca](http://www.legrand.ca)

