

Straight Blade Devices
 15A, 125V, 2 Pole, 3 Wire Grounding
 Hubbell-Pro™ Heavy Duty Duplex
 Receptacles

HUBBELL

Features

- Slender/compact design
- Smooth face
- Triple wipe contacts

Ordering Information

Description	Device Color	UPC	Catalog Number
Back and side wired	White	783585109725	5252AW

Listings

UL File No. E2186
 Certified to CSA 22.2, No. 42 File 285
 Fed. Spec. W-C-596
 NEMA® WD-6 Compliant

Specifications

Face	Nylon
Base	PBT
Contacts	Brass
Mounting Strap	Galvanized steel
Automatic Self-grounding Staple	Stainless steel
Mounting Screws	Zinc plated steel

Performance

Electrical	
Current Interrupting	Certified for current interrupting at full rated current
Dielectric Voltage	Withstands 2,000V minimum
Mechanical	
Product Identification	Ratings are a permanent part of the device
Terminal Accommodation	#14-#10 AWG copper stranded or solid conductor only
Terminal Identification	Terminal wire leads identified in accordance with UL 498
Environmental	
Flammability	UL 94 V-2
Operating Temperatures	Maximum continuous 75°C; minimum -40°C (w/o impact)

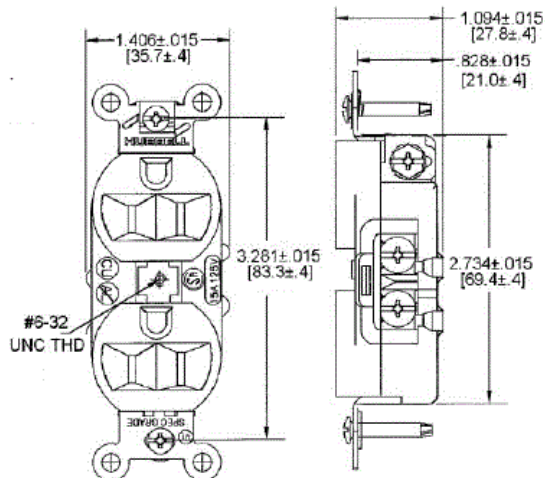

Accessories

Wallplate or Weatherproof Cover Duplex Opening

Resources

Customer Use Drawing
 eCatalog

Dimensions in Inches (mm)

Hubbell Wiring Device-Kellems • Hubbell Incorporated (Delaware) • 40 Waterview Drive • Shelton, CT 06484

Phone (800) 288-6000 • Fax (800) 255-1031 • Specifications subject to change without notice.

