

DESCRIPTION

Recessed 6-inch LED lens downlight is available in various distributions, lumen and CRI/CCT options. Suitable for commercial construction and can be used for both new or renovation work. Insulation must be kept 3" from top and sides of housing. Use for general area lighting where high efficiency and visual comfort are required.

Catalog #		Type
Project		
Comments		Date
Prepared by		

SPECIFICATION FEATURES

MECHANICAL

Frame

Boat shaped galvanized steel frame with adjustable plaster lip accommodates ceilings up to 1/2" - 2" thick. May be used for new construction or remodeling installations. Provided with (2) remodel clips to secure frame when installed from below the ceiling.

Mounting Brackets

Bar hanger receivers adjusts 2" vertically from above the ceiling or thru the aperture. Use with No Fuss™ bar hangers or with 1/2" EMT. Removable to facilitate installation from below the ceiling.

No Fuss™ Bar Hangers

Captive preinstalled bar hanger locks to tee grid with a screwdriver or pliers. Centering mechanism allows consistent positioning of fixtures.

OPTICAL

LED Module

Proximity phosphors over chip on board LEDs provide a uniform source with high efficiency and no pixilation. Available in 80 or 90 CRI minimum, accuracy within 3 SDCM provides color uniformity. See ordering information for available CRI / CCT options. Passive thermal management achieves L70 at 50,000 hours in non IC applications. Integral diffuse lens provides visual shielding. Integral connector allows quick connection to housing flex.

Reflector

One piece parabolic aluminum reflector provides cutoff for a visually comfortable optic. Attaches to LED module with (3) speed clamps minimizing light leaks to lens. Self-flanged standard with an optional white painted flange.

Trim Retention

Reflectors are retained with two torsion springs holding the flange tightly to the finished ceiling surface.

ELECTRICAL Junction Box

(6) 1/2" and (2) 3/4" trade size pry outs positioned to allow straight conduit runs. Listed for (12) #12 AWG (six in, six out) 90°C conductors and feed thru branch wiring.

Driver

Integral UNV 120 - 277V 50/60 Hz constant current driver provides noise free operation. For 347V input use Halo transformer H347 or H347200. Continuous, flicker-free dimming from 100% to 10% with leading or trailing edge phase cut at 120V or 0 -10V analog control.

Emergency Option

Provides 90 minutes of standby lighting meeting most life safety codes for egress lighting. Available with both integral or remote charge indicator and test switch.

Compliance

- cULus listed for wet location
- IP66 Ingress Protection Rated
- Insulation must be kept 3" from top and sides.
- Airtight per ASTM-E283.
- Optional City of Chicago environmental air (CCEA) marking for plenum applications.
- EMI/RFI emissions per FCC 47CFR Part 18 non-consumer limits.
- Contains no mercury or lead and RoHS compliant.
- Photometric testing in accordance with IES LM-79-08.
- Lumen maintenance projections in accordance with IES LM-80-08 and TM-21-11.
- Can be used to comply with California Title 24 Non-Residential Lighting Controls requirements as a LED Luminaire.
- ENERGY STAR® listed for commercial applications, reference database for current listings.



PD610
PD615
PD620
PD630

PDM6A

61V

1000, 1500,
2000 & 3000
Lumen Series

LED
6-Inch Aperture
Lens Downlight

THD: ≤ 20%
PF: ≥ 0.90
T Ambient -30 - +40°C
Sound Rating ≤ 22dba

Lumens	1000 Series	
Input Voltage	120V	277V
Input Current	.103 A	.058 A
Input Power	12.1 W	13.2 W
Efficiency	88 LPW	88 LPW
Inrush Current	0.37 A	0.77 A

Lumens	1500 Series	
Input Voltage	120V	277V
Input Current	.146 A	0.072 A
Input Power	17.1 W	17.9 W
Efficiency	87 LPW	87 LPW
Inrush Current	0.47 A	1.04 A

Lumens	2000 Series	
Input Voltage	120V	277V
Input Current	.175 A	0.086 A
Input Power	20.78 W	21.06 W
Efficiency	89 LPW	89 LPW
Inrush Current	0.54 A	1.21 A

Lumens	3000 Series	
Input Voltage	120V	277V
Input Current	.299 A	.145 A
Input Power	35.72 W	36.4 W
Efficiency	82 LPW	82 LPW
Inrush Current	0.85 A	2.0 A

ORDERING INFORMATION

SAMPLE NUMBER: PD610ED010REM-PDM6A827-61VC

A complete luminaire consists of a housing, LED module and reflector, order separately.

Housing	Lumens	Driver	Options	LED Module	CRI/CCT
PD6 = 6" aperture LED downlight PD6CP = 6" aperture LED downlight, CCEA listed for City of Chicago plenum requirements	10 = 1,000 lumens (nominal) 15 = 1,500 lumens (nominal) 20 = 2,000 lumens (nominal)	ED010 = 120-277V 50/60Hz, 0-10V and LE/TE phase cut dimming	REM = Emergency operation with remote indicator and test switch IEM = Emergency operation with integral indicator and test switch, 60 Hz only (REM and IEM options not available with PD6CP housing)	PDM6A = Downlight LED module for PD6 housing, provides 1,000, 1,500, 2,000, or 3,000 lumens (nominal) depending on connected housing type	827 = 80 CRI, 2700K CCT 927 = 90 CRI, 2700K CCT 830 = 80 CRI, 3000K CCT 930 = 90 CRI, 3000K CCT 835 = 80 CRI, 3500K CCT 935 = 90 CRI, 3500K CCT 840 = 80 CRI, 4000K CCT 940 = 90 CRI, 4000K CCT
	30 = 3,000 lumens (nominal)	D010 = 120-277V 50/60Hz, 0-10V dimming (3,000 lumen only)			

Reflector	Finish Option	Flange Option	Accessories
61V = 6" vertical parabolic reflector 61VEM = 6" vertical parabolic reflector for IEM	C = Specular clear G = Specular gold H = Semi-specular clear W = White (white flange) BB = Black baffle (white flange) WB = White baffle (white flange)	Blank = Polished flange standard with C, G & H reflector finishes Blank = White flange standard with W, BB, & WB WF = White flange option available with C, G, & H reflector finishes	HB128APK = L channel hanger bar, 26", 'No-Fuss', pair (replacement) RMB22 = 22" long wood joist mounting bars, pair H347 = Step down transformer for 347V input H347 = Step down transformer for 347V input, 75VA max H347200 = Step down transformer for 347V input, 200VA max PORLWTPD1 = LumaWatt Pro Wireless Sensor Kit (0-10V only)

DIMENSIONS

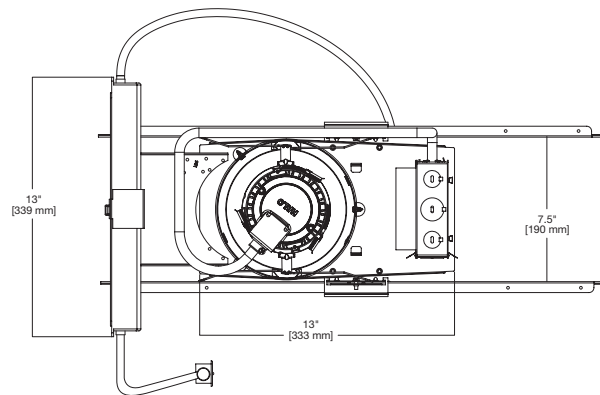
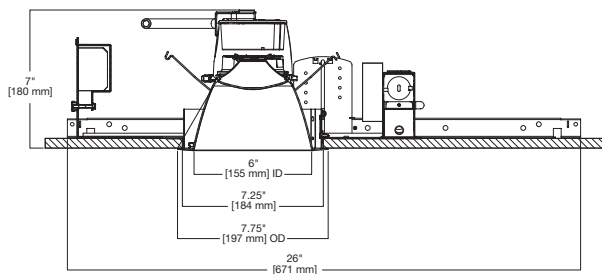
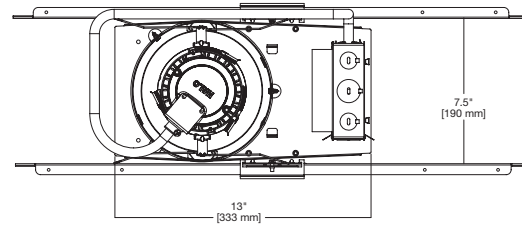
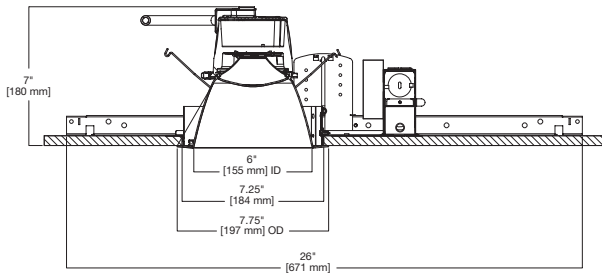

COMPLIANCE TABLE

1000 LUMEN

80 CRI																
Catalog #	PD610ED010- PDM6A827				PD610ED010- PDM6A830				PD610ED010- PDM6A835				PD610ED010- PDM6A840			
	LUMENS	LPW	ES	T24	LUMENS	LPW	ES	T24	LUMENS	LPW	ES	T24	LUMENS	LPW	ES	T24
61VC	1032	77	ES	T24	1109	83	ES	T24	1177	88	ES	T24	1187	89	ES	T24
61VCWF	1005	75	ES	T24	1080	81	ES	T24	1146	86	ES	T24	1156	86	ES	T24
61VG	1003	75	ES	T24	1078	80	ES	T24	1144	85	ES	T24	1154	86	ES	T24
61VGWF	966	72	ES	T24	1039	78	ES	T24	1102	82	ES	T24	1111	83	ES	T24
61VH	924	69	ES	T24	993	74	ES	T24	1053	79	ES	T24	1062	79	ES	T24
61VHWF	921	69	ES	T24	990	74	ES	T24	1051	78	ES	T24	1060	79	ES	T24
61VW	960	72	ES	T24	1032	77	ES	T24	1095	82	ES	T24	1104	82	ES	T24
61VBB	897	67	ES	T24	964	72	ES	T24	1023	76	ES	T24	1031	77	ES	T24
61VWB	980	73	ES	T24	1053	79	ES	T24	1118	83	ES	T24	1127	84	ES	T24

90 CRI																
Catalog #	PD610ED010- PDM6A927				PD610ED010- PDM6A930				PD610ED010- PDM6A935				PD610ED010- PDM6A940			
	LUMENS	LPW	ES	T24	LUMENS	LPW	ES	T24	LUMENS	LPW	ES	T24	LUMENS	LPW	ES	T24
61VC	795	59	ES	T24	853	64	ES	T24	917	68	ES	T24	1017	76	ES	T24
61VCWF	775	58	ES	T24	831	62	ES	T24	894	67	ES	T24	990	74	ES	T24
61VG	773	58	ES	T24	829	62	ES	T24	892	67	ES	T24	988	74	ES	T24
61VGWF	745	56	ES	T24	799	60	ES	T24	859	64	ES	T24	952	71	ES	T24
61VH	712	53	ES	T24	763	57	ES	T24	821	61	ES	T24	910	68	ES	T24
61VHWF	710	53	ES	T24	761	57	ES	T24	819	61	ES	T24	908	68	ES	T24
61VW	740	55	ES	T24	794	59	ES	T24	854	64	ES	T24	946	71	ES	T24
61VBB	691	52	ES	T24	741	55	ES	T24	797	59	ES	T24	884	66	ES	T24
61VWB	755	56	ES	T24	810	60	ES	T24	871	65	ES	T24	966	72	ES	T24

1500 LUMEN

80 CRI																
Catalog #	PD615ED010- PDM6A827				PD615ED010- PDM6A830				PD615ED010- PDM6A835				PD615ED010- PDM6A840			
	LUMENS	LPW	ES	T24	LUMENS	LPW	ES	T24	LUMENS	LPW	ES	T24	LUMENS	LPW	ES	T24
61VC	1417	77	ES	T24	1523	82	ES	T24	1616	87	ES	T24	1630	88	ES	T24
61VCWF	1380	75	ES	T24	1483	80	ES	T24	1574	85	ES	T24	1587	86	ES	T24
61VG	1377	74	ES	T24	1480	80	ES	T24	1570	85	ES	T24	1584	86	ES	T24
61VGWF	1327	72	ES	T24	1426	77	ES	T24	1513	82	ES	T24	1526	82	ES	T24
61VH	1268	69	ES	T24	1363	74	ES	T24	1446	78	ES	T24	1458	79	ES	T24
61VHWF	1265	68	ES	T24	1359	73	ES	T24	1442	78	ES	T24	1455	79	ES	T24
61VW	1318	71	ES	T24	1417	77	ES	T24	1503	81	ES	T24	1516	82	ES	T24
61VBB	1231	67	ES	T24	1323	72	ES	T24	1404	76	ES	T24	1416	77	ES	T24
61VWB	1346	73	ES	T24	1446	78	ES	T24	1534	83	ES	T24	1548	84	ES	T24

90 CRI																
Catalog #	PD615ED010- PDM6A927				PD615ED010- PDM6A930				PD615ED010- PDM6A935				PD615ED010- PDM6A940			
	LUMENS	LPW	ES	T24	LUMENS	LPW	ES	T24	LUMENS	LPW	ES	T24	LUMENS	LPW	ES	T24
61VC	1092	59	ES	T24	1171	63	ES	T24	1260	68	ES	T24	1396	75	ES	T24
61VCWF	1064	57	ES	T24	1141	62	ES	T24	1227	66	ES	T24	1360	74	ES	T24
61VG	1061	57	ES	T24	1138	62	ES	T24	1224	66	ES	T24	1357	73	ES	T24
61VGWF	1022	55	ES	T24	1096	59	ES	T24	1179	64	ES	T24	1307	71	ES	T24
61VH	977	53	ES	T24	1048	57	ES	T24	1127	61	ES	T24	1249	68	ES	T24
61VHWF	975	53	ES	T24	1045	57	ES	T24	1124	61	ES	T24	1246	67	ES	T24
61VW	1016	55	ES	T24	1090	59	ES	T24	1172	63	ES	T24	1299	70	ES	T24
61VBB	949	51	ES	T24	1018	55	ES	T24	1095	59	ES	T24	1213	66	ES	T24
61VWB	1037	56	ES	T24	1112	60	ES	T24	1196	65	ES	T24	1326	72	ES	T24

ES ES = ENERGY STAR® Compliant

T24 T24 = Can be used to comply with California Title 24 Non-Residential

COMPLIANCE TABLE continued

2000 LUMEN

80 CRI																
Catalog #	PD620ED010- PDM6A827				PD620ED010- PDM6A830				PD620ED010- PDM6A835				PD620ED010- PDM6A840			
	LUMENS	LPW	ES	T24	LUMENS	LPW	ES	T24	LUMENS	LPW	ES	T24	LUMENS	LPW	ES	T24
61VC	1724	78	ES	T24	1853	84	ES	T24	1966	89	ES	T24	1983	90	ES	T24
61VCWF	1679	76	ES	T24	1805	82	ES	T24	1915	87	ES	T24	1931	88	ES	T24
61VG	1675	76	ES	T24	1801	82	ES	T24	1910	87	ES	T24	1927	88	ES	T24
61VGWF	1614	73	ES	T24	1735	79	ES	T24	1841	84	ES	T24	1856	84	ES	T24
61VH	1543	70	ES	T24	1658	75	ES	T24	1759	80	ES	T24	1774	81	ES	T24
61VHWF	1539	70	ES	T24	1654	75	ES	T24	1755	80	ES	T24	1770	80	ES	T24
61VW	1604	73	ES	T24	1724	78	ES	T24	1829	83	ES	T24	1845	84	ES	T24
61VBB	1498	68	ES	T24	1610	73	ES	T24	1708	78	ES	T24	1723	78	ES	T24
61VWB	1637	74	ES	T24	1759	80	ES	T24	1867	85	ES	T24	1883	86	ES	T24

90 CRI																
Catalog #	PD620ED010- PDM6A927				PD620ED010- PDM6A930				PD620ED010- PDM6A935				PD620ED010- PDM6A940			
	LUMENS	LPW	ES	T24	LUMENS	LPW	ES	T24	LUMENS	LPW	ES	T24	LUMENS	LPW	ES	T24
61VC	1328	60	ES	T24	1425	65	ES	T24	1532	70	ES	T24	1698	77	ES	T24
61VCWF	1294	59	ES	T24	1388	63	ES	T24	1493	68	ES	T24	1654	75	ES	T24
61VG	1291	59	ES	T24	1385	63	ES	T24	1489	68	ES	T24	1651	75	ES	T24
61VGWF	1244	57	ES	T24	1334	61	ES	T24	1435	65	ES	T24	1590	72	ES	T24
61VH	1189	54	ES	T24	1275	58	ES	T24	1371	62	ES	T24	1520	69	ES	T24
61VHWF	1186	54	ES	T24	1272	58	ES	T24	1368	62	ES	T24	1516	69	ES	T24
61VW	1236	56	ES	T24	1325	60	ES	T24	1426	65	ES	T24	1580	72	ES	T24
61VBB	1154	52	ES	T24	1238	56	ES	T24	1332	61	ES	T24	1476	67	ES	T24
61VWB	1262	57	ES	T24	1353	61	ES	T24	1455	66	ES	T24	1613	73	ES	T24

3000 LUMEN

80 CRI																
Catalog #	PD630D010- PDM6A827				PD630D010- PDM6A830				PD630D010- PDM6A835				PD630D010- PDM6A840			
	LUMENS	LPW	ES	T24	LUMENS	LPW	ES	T24	LUMENS	LPW	ES	T24	LUMENS	LPW	ES	T24
61VC	2576	72	ES	T24	2768	78	ES	T24	2937	82	ES	T24	2963	83	ES	T24
61VCWF	2509	70	ES	T24	2697	76	ES	T24	2861	80	ES	T24	2886	81	ES	T24
61VG	2503	70	ES	T24	2691	75	ES	T24	2855	80	ES	T24	2879	81	ES	T24
61VGWF	2412	68	ES	T24	2592	73	ES	T24	2750	77	ES	T24	2774	78	ES	T24
61VH	2305	65	ES	T24	2477	69	ES	T24	2629	74	ES	T24	2651	74	ES	T24
61VHWF	2299	64	ES	T24	2471	69	ES	T24	2622	73	ES	T24	2645	74	ES	T24
61VW	2397	67	ES	T24	2576	72	ES	T24	2733	77	ES	T24	2757	77	ES	T24
61VBB	2238	63	ES	T24	2406	67	ES	T24	2553	72	ES	T24	2575	72	ES	T24
61VWB	2446	69	ES	T24	2629	74	ES	T24	2790	78	ES	T24	2814	79	ES	T24

90 CRI																
Catalog #	PD630D010- PDM6A927				PD630D010- PDM6A930				PD630D010- PDM6A935				PD630D010- PDM6A940			
	LUMENS	LPW	ES	T24	LUMENS	LPW	ES	T24	LUMENS	LPW	ES	T24	LUMENS	LPW	ES	T24
61VC	1985	56	ES	T24	2129	60	ES	T24	2290	64	ES	T24	2538	71	ES	T24
61VCWF	1934	54	ES	T24	2074	58	ES	T24	2231	62	ES	T24	2472	69	ES	T24
61VG	1929	54	ES	T24	2069	58	ES	T24	2226	62	ES	T24	2466	69	ES	T24
61VGWF	1859	52	ES	T24	1993	56	ES	T24	2144	60	ES	T24	2376	67	ES	T24
61VH	1776	50	ES	T24	1905	53	ES	T24	2049	57	ES	T24	2271	64	ES	T24
61VHWF	1772	50	ES	T24	1900	53	ES	T24	2044	57	ES	T24	2265	63	ES	T24
61VW	1847	52	ES	T24	1981	55	ES	T24	2131	60	ES	T24	2361	66	ES	T24
61VBB	1725	48	ES	T24	1850	52	ES	T24	1990	56	ES	T24	2205	62	ES	T24
61VWB	1885	53	ES	T24	2022	57	ES	T24	2175	61	ES	T24	2410	68	ES	T24

ES ES = ENERGY STAR® Compliant

T24 T24 = Can be used to comply with California Title 24 Non-Residential

PHOTOMETRY - 1000 lumen / 80 CRI

PD610ED010- PDM6A835-61VC

Spacing Criteria = 0.76
Lumens per Watt = 97.3 Lm/W
Test No. P137037
Test Model: PD610ED010- PDM6A835-61VC

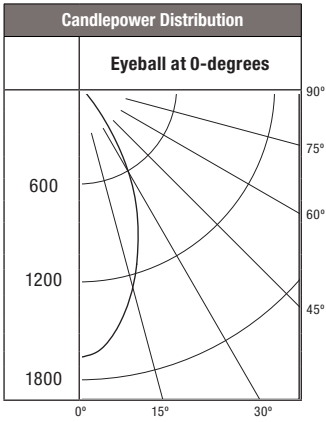

Candela Distribution	
Degrees Vertical	Candela
0*	1665
5	1614
10	1469
20	1057
30	609
40	166
50	18
60	3
70	1
80	0
90	0

*CBCP

Luminance	
(Average Candela/M ²)	
Degree	Avg. 0° Luminance
45	4791
55	497
65	221
75	191
85	0

Cone of Light Footcandles			
Distance to Illuminated Plane	Initial Nadir Footcandles	Beam (ft.)	
		L Length	W Width
5.5	55.1	4	4
7	34	5.2	5.2
8	26	6	6
9	20.6	6.8	6.8
10	16.7	7.6	7.6
12	11.6	9	9

Beam diameter is to 50% of maximum footcandles, rounded to the nearest half-foot. Footcandle values are initial, apply appropriate light loss factors where necessary.

Zonal Lumen Summary		
Zone	Lumens	% Fixture
0-30	886	75.3
0-40	1113	94.6
0-60	1175	99.8
0-90	1177	100

Scaling factor for the Battery back up:

- 1000 Lumen = 0.55
- 1500 Lumen = 0.40
- 2000 Lumen = 0.33
- 3000 Lumen = 0.22

PHOTOMETRY - 1000 lumen / 90 CRI

PD610ED010- PDM6A935-61VC

Spacing Criteria = 0.76
Lumens per Watt = 75.8 Lm/W
Test No. P137041
Test Model: PD610ED010- PDM6A935-61VC

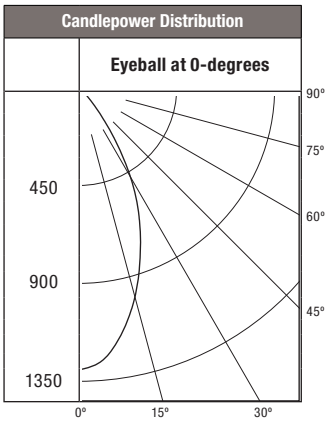

Candela Distribution	
Degrees Vertical	Candela
0*	1298
5	1258
10	1146
20	824
30	475
40	130
50	14
60	2
70	1
80	0
90	0

*CBCP

Luminance	
(Average Candela/M ²)	
Degree	Avg. 0° Luminance
45	3737
55	392
65	182
75	148
85	0

Cone of Light Footcandles			
Distance to Illuminated Plane	Initial Nadir Footcandles	Beam (ft.)	
		L Length	W Width
5.5'	52	4.4	4.4
7'	32.1	5.8	5.8
8'	24.6	6.6	6.6
9'	19.4	7.4	7.4
10'	15.7	8.2	8.2
12'	10.9	10	10

Beam diameter is to 50% of maximum footcandles, rounded to the nearest half-foot. Footcandle values are initial, apply appropriate light loss factors where necessary.

Zonal Lumen Summary		
Zone	Lumens	% Fixture
0-30	691	75.3
0-40	868	94.6
0-60	916	99.8
0-90	917	100

Scaling factor for the Battery back up:

- 1000 Lumen = 0.55
- 1500 Lumen = 0.40
- 2000 Lumen = 0.33
- 3000 Lumen = 0.22

PHOTOMETRY - 1500 lumen / 80 CRI

PD615ED010- PDM6A835-61VC
Spacing Criteria = 0.76
Lumens per Watt = 87.3 Lm/W
Test No. P166938
Test Model: PD615ED010- PDM6A835-61VC

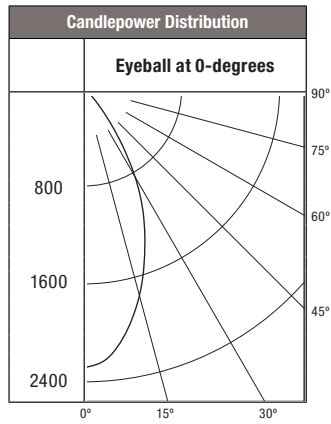

Candela Distribution	
Degrees Vertical	Candela
0*	2287
5	2216
10	2018
20	1452
30	836
40	228
50	25
60	4
70	1
80	0
90	0

*CBCP

Luminance	
(Average Candela/M ²)	
Degree	Avg. 0° Luminance
45	6582
55	688
65	311
75	254
85	0

Cone of Light Footcandles			
Distance to Illuminated Plane	Initial Nadir Footcandles	Beam (ft.)	
		L Length	W Width
5.5	75.6	4	4
7	46.7	5.2	5.2
8	35.7	6	6
9	28.2	6.8	6.8
10	22.9	7.6	7.6
12	15.9	9	9

Beam diameter is to 50% of maximum footcandles, rounded to the nearest half-foot. Footcandle values are initial, apply appropriate light loss factors where necessary.

Zonal Lumen Summary		
Zone	Lumens	% Fixture
0-30	1217	75.3
0-40	1529	94.6
0-60	1613	99.8
0-90	1616	100

Scaling factor for the Battery back up:

- 1000 Lumen = 0.55
- 1500 Lumen = 0.40
- 2000 Lumen = 0.33
- 3000 Lumen = 0.22

PHOTOMETRY - 1500 lumen / 90 CRI

PD615ED010- PDM6A935-61VC
Spacing Criteria = 0.76
Lumens per Watt = 68.1 Lm/W
Test No. P166942
Test Model: PD615ED010- PDM6A935-61VC

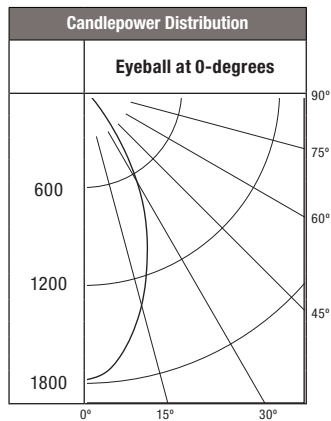

Candela Distribution	
Degrees Vertical	Candela
0*	1783
5	1728
10	1573
20	1132
30	652
40	178
50	20
60	3
70	1
80	0
90	0

*CBCP

Luminance	
(Average Candela/M ²)	
Degree	Avg. 0° Luminance
45	5132
55	535
65	246
75	191
85	0

Cone of Light Footcandles			
Distance to Illuminated Plane	Initial Nadir Footcandles	Beam (ft.)	
		L Length	W Width
5.5	58.9	4	4
7	36.4	5.2	5.2
8	27.9	6	6
9	22	6.8	6.8
10	17.8	7.6	7.6
12	12.4	9	9

Beam diameter is to 50% of maximum footcandles, rounded to the nearest half-foot. Footcandle values are initial, apply appropriate light loss factors where necessary.

Zonal Lumen Summary		
Zone	Lumens	% Fixture
0-30	948	75.3
0-40	1192	94.6
0-60	1257	99.8
0-90	1260	100

Scaling factor for the Battery back up:

- 1000 Lumen = 0.55
- 1500 Lumen = 0.40
- 2000 Lumen = 0.33
- 3000 Lumen = 0.22

PHOTOMETRY - 2000 lumen / 80 CRI

PD620ED010- PDM6A835-61VC

Spacing Criteria = 0.76
Lumens per Watt = 89.4 Lm/W
Test No. P137021
Test Model: PD620ED010- PDM6A835-61VC

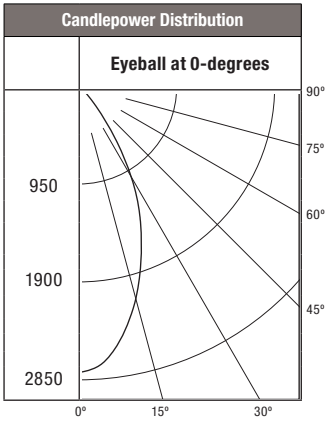

Scaling factor for the Battery back up:

- 1000 Lumen = 0.55
- 1500 Lumen = 0.40
- 2000 Lumen = 0.33
- 3000 Lumen = 0.22

Candela Distribution	
Degrees Vertical	Candela
0*	2782
5	2696
10	2454
20	1766
30	1017
40	278
50	31
60	4
70	2
80	0
90	0

*CBCP

Luminance	
(Average Candela/M ²)	
Degree	Avg. 0° Luminance
45	8009
55	832
65	376
75	318
85	0

Cone of Light Footcandles			
Distance to Illuminated Plane	Initial Nadir Footcandles	Beam (ft.)	
		L Length	W Width
5.5	92	4	4
7	56.8	5.2	5.2
8	43.5	6	6
9	34.3	6.8	6.8
10	27.8	7.6	7.6
12	19.3	9	9

Beam diameter is to 50% of maximum footcandles, rounded to the nearest half-foot.
Footcandle values are initial, apply appropriate light loss factors where necessary.

Zonal Lumen Summary		
Zone	Lumens	% Fixture
0-30	1480	75.3
0-40	1860	94.6
0-60	1962	99.8
0-90	1966	100

PHOTOMETRY - 2000 lumen / 90 CRI

PD620ED010- PDM6A935-61VC

Spacing Criteria = 0.76
Lumens per Watt = 69.7 Lm/W
Test No. P137025
Test Model: PD620ED010- PDM6A935-61VC

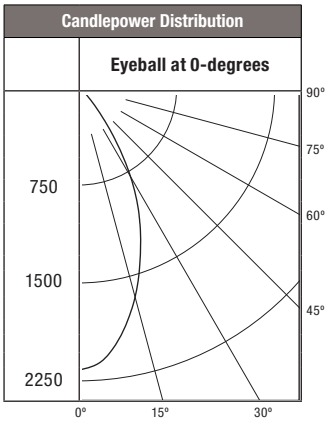

Scaling factor for the Battery back up:

- 1000 Lumen = 0.55
- 1500 Lumen = 0.40
- 2000 Lumen = 0.33
- 3000 Lumen = 0.22

Candela Distribution	
Degrees Vertical	Candela
0*	2168
5	2102
10	1913
20	1377
30	793
40	217
50	24
60	3
70	1
80	0
90	0

*CBCP

Luminance	
(Average Candela/M ²)	
Degree	Avg. 0° Luminance
45	6241
55	650
65	298
75	233
85	0

Cone of Light Footcandles			
Distance to Illuminated Plane	Initial Nadir Footcandles	Beam (ft.)	
		L Length	W Width
5.5	71.7	4	4
7	44.3	5.2	5.2
8	33.9	6	6
9	26.8	6.8	6.8
10	21.7	7.6	7.6
12	15.1	9	9

Beam diameter is to 50% of maximum footcandles, rounded to the nearest half-foot.
Footcandle values are initial, apply appropriate light loss factors where necessary.

Zonal Lumen Summary		
Zone	Lumens	% Fixture
0-30	1154	75.3
0-40	1450	94.6
0-60	1530	99.8
0-90	1532	100

PHOTOMETRY - 3000 lumen / 80 CRI

PD630ED010- PDM6A835-61VC

Spacing Criteria = 0.76
Lumens per Watt = 82.3 Lm/W
Test No. P137053
Test Model: PD630ED010- PDM6A835-61VC

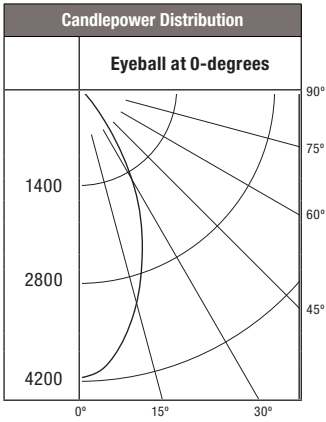

Candela Distribution	
Degrees Vertical	Candela
0*	4157
5	4028
10	3668
20	2639
30	1520
40	415
50	46
60	6
70	2
80	0
90	0

*CBCP

Luminance	
(Average Candela/M²)	
Degree	Avg. 0° Luminance
45	11970
55	1242
65	558
75	466
85	0

Cone of Light Footcandles			
Distance to Illuminated Plane	Initial Nadir Footcandles	Beam (ft.)	
		L Length	W Width
5.5	137.4	4	4
7	84.8	5.2	5.2
8	65	6	6
9	51.3	6.8	6.8
10	41.6	7.6	7.6
12	28.9	9	9

Beam diameter is to 50% of maximum footcandles, rounded to the nearest half-foot. Footcandle values are initial, apply appropriate light loss factors where necessary.

Zonal Lumen Summary		
Zone	Lumens	% Fixture
0-30	2212	75.3
0-40	2779	94.6
0-60	2932	99.8
0-90	2937	100

Scaling factor for the Battery back up:

- 1000 Lumen = 0.55
- 1500 Lumen = 0.40
- 2000 Lumen = 0.33
- 3000 Lumen = 0.22

PHOTOMETRY - 3000 lumen / 90 CRI

PD630ED010- PDM6A935-61VC

Spacing Criteria = 0.76
Lumens per Watt = 64.1 Lm/W
Test No. P137057
Test Model: PD630ED010- PDM6A935-61VC

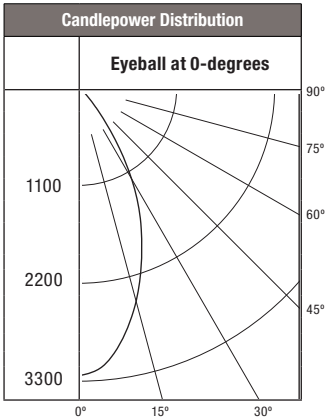

Candela Distribution	
Degrees Vertical	Candela
0*	3240
5	3140
10	2859
20	2058
30	1185
40	324
50	36
60	5
70	2
80	0
90	0

*CBCP

Luminance	
(Average Candela/M²)	
Degree	Avg. 0° Luminance
45	9327
55	975
65	441
75	360
85	0

Cone of Light Footcandles			
Distance to Illuminated Plane	Initial Nadir Footcandles	Beam (ft.)	
		L Length	W Width
5.5	107.1	4	4
7	66.1	5.2	5.2
8	50.6	6	6
9	40	6.8	6.8
10	32.4	7.6	7.6
12	22.5	9	9

Beam diameter is to 50% of maximum footcandles, rounded to the nearest half-foot. Footcandle values are initial, apply appropriate light loss factors where necessary.

Zonal Lumen Summary		
Zone	Lumens	% Fixture
0-30	1724	75.3
0-40	2166	94.6
0-60	2286	99.8
0-90	2290	100

Scaling factor for the Battery back up:

- 1000 Lumen = 0.55
- 1500 Lumen = 0.40
- 2000 Lumen = 0.33
- 3000 Lumen = 0.22