

3/16" Wall Thickness

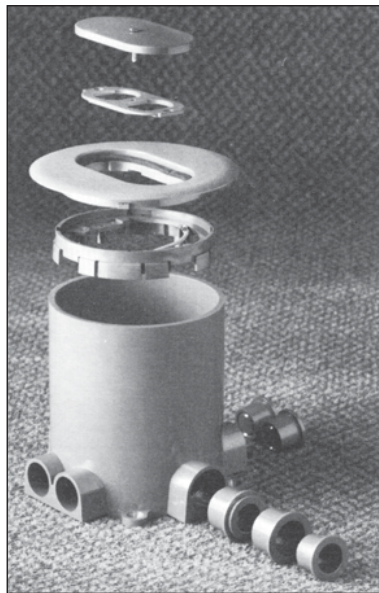
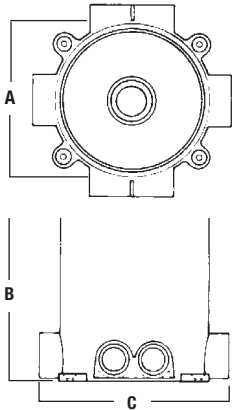

68-P Round Non-Metallic Floor Box

The 68-P floor box provides flush service for power or communications and data. The non-metallic floor box is used in concrete floors and is suitable for carpet, tile or wood applications.

- High-strength rigid PVC construction, non-corrosive
- Easy installation with no leveling required — just cut the box level with the concrete after the pour
- Compatible with standard schedule PVC conduit (1", 3/4" and 1/2", reducers included)
- Pre-packaged with Concrete Cap and Six Hub Plugs.

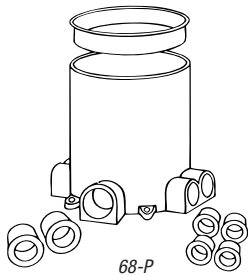

68-P



CAT. NO.	DIMENSIONS (IN.)			AFTER POUR ADJ.	MAXIMUM CAPACITY (CU. IN.)	STANDARD CONDUIT TAPPING	COVERS AND CARPET PLATES	WIRING DEVICE	STD. CTN.
	A	B	C						
68-P	5 1/2	6	6 1/2	None	100	(4) - 3/4" (2) - 1"	P60 P68 series	Single duplex or data/voice	8

Minimum pour 3 inches.

Cubic in. capacity is 17 cubic inches per inch of box height.

NOTE: Must use 68-PAR to attach cover plates to 68-P floor box.

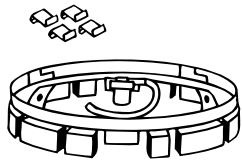

68-PAR

Adjusting Ring for 68-P Floor Box

- Non-metallic adjusting ring includes pigtail and clips



CAT. NO.	DESCRIPTION	STD. CTN.
68-PAR	Non-metallic adjusting ring	8

Required to mount P60 and P68 Series covers to 68P floor box (not needed for Dual Voltage Kits).



68P-FL/68P-FL-AL

Metallic Tile Trims for 68-P Floor Box

- Tile trim rings are available in brass or aluminum for flush installation of metallic plates in linoleum, wood or carpeted floors. Must be used to mount P60 series plates. (Not required for P-68 covers, P60-CACP or P60-3/4-2-CACP)



CAT. NO.	DESCRIPTION	STD. CTN.
68P-FL	Tile trim ring, brass	4
68P-FL-AL	Tile trim ring, aluminum	4

Required to attach P60 Series cover plates to 68-P floor box.



Dual Voltage Kits for 68-P Non-Metallic Series

Thomas & Betts announces the 68P dual voltage kit designed to be used with the 68P non-metallic round floor box. It accommodates one standard duplex or GFCI-style receptacle, and four data/communication jacks.

As with T&B rectangular flush service floor boxes, the new 68P Dual Voltage Kit utilizes the T&B exclusive "one-step" installation method. No glue required! The mounting ring comes equipped with barbs that allow the installer to "press-fit" in place.

- Voltage divider has easy-cut score lines to accommodate concrete depths of 3 to 6 inches
- Faceplate has removable data plates and can accommodate GFCI or standard duplex receptacles
- Kit comes equipped with 4 standard keystone size openings in the data plates. Other styles available include openings sized for Ortronics, Avaya, Panduit and Hubbell
- Easily change out data plates after installation, unlike the competition
- MopTite® cover uses a "snap-lock" to close the lid. No screws to turn...just push down the lid and it snaps in place. The cover uses a factory-installed gasket and exceeds all UL scrub-water exclusion requirements for carpet, wood and tile floors
- MopTite® cover available in solid brass or aluminum
- Includes everything required for a standard installation (68P floor box, data jacks and receptacles not included)

NEW!



68-P Dual Voltage Kit



CAT. NO.	DESCRIPTION	STD. CTN.
68P-DV-KIT-BRS	Dual voltage divider kit with MopTite® Brass Cover	1
68P-DV-KIT-AL	Dual voltage divider kit with MopTite aluminum cover	1
68P-DV-DP-ORT	Ortronics data plate to accommodate 2 jacks	10
68P-DV-DP-AVA	Avaya data plate to accommodate 4 jacks	10
68P-DV-DP-PAN	Panduit data plate to accommodate 2 jacks	10
68P-DV-DP	Standard data plate to accommodate 4 Keystone jacks	10

*Keystone data plates come standard with the kit. Other style data plates are available from T&B and can be ordered separately.

Steel City® Floor Boxes

MopTite® Metallic Carpet Plates for 68-P Series

- Brushed brass finish
- Furnished complete with 8-32 x 1" brass screws
- For brushed aluminum, add AL after catalog number

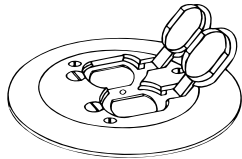

P60-CACP
One piece, solid brass duplex plate with screw-lock lids. 5 1/4" O.D. Mounting holes on a 3 3/4" dia.

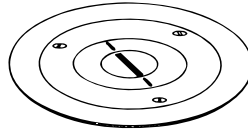

P60-3/4-2-CACP
One piece solid brass communications carpet plate. 5 1/4" O.D. Mounting holes on a 3 3/4" dia.

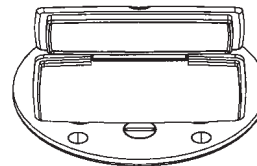

P60-CACP-GFCI
5 1/4" O.D.



P60-CP
5 1/8" O.D.



CAT. NO.	DESCRIPTION	FINISH	STD. CTN.
P60-CACP	One-piece duplex cover and carpet flange brass	—	4
P60-CACP-AL	One-piece duplex cover and carpet flange aluminum	—	4
P60-3/4-2-CACP	One-piece cover & carpet flange with 3/4" and 2" plugs	Brass	4
P60-3/4-2-CACP-AL	One-piece cover & carpet flange with 3/4" and 2" plugs	Aluminum	4
P60-CACP-GFCI*	One-piece GFCI cover and carpet flange	Brass	4
P60-CACP-GFCI-AL*	One-piece GFCI cover and carpet flange	Aluminum	4
P60-CP*	Carpet flange	Brass	4
P60-CP-AL*	Carpet flange	Aluminum	4

*Requires 68P-FL or 68P-FL-AL to attach covers to 68-P Floor Box.

New MopTite® Covers exceed UL watertight requirements for 514A, 514C.

MopTite® Non-Metallic Carpet Plates for 68-P Series

Non-metallic, single receptacle plate (SRC) with matching carpet plate and cover. 6" O.D.

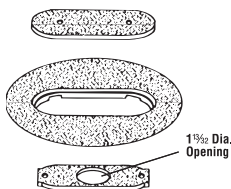

Non-metallic floor service cover (FSC) with 1" NPS screw plug accommodates most above-floor service fittings with matching carpet plate. 6" O.D.

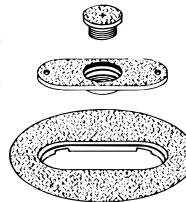

Non-metallic, duplex/voice data receptacle plates (DRC) with matching carpet plate and cover. 6" O.D.

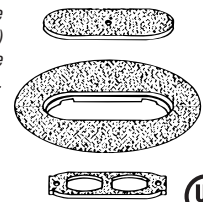

CAT. NO.	COLOR	DESCRIPTION	STD. CTN.
P-68-SRC-GRY	Gray	Non-metallic carpet plate and cover for single receptacle	4
P-68-SRC-BRN	Brown	Non-metallic carpet plate and cover for single receptacle	4
P-68-SRC-BGE	Beige	Non-metallic carpet plate and cover for single receptacle	4
P-68-SRC-BLK	Black	Non-metallic carpet plate and cover for single receptacle	4
P-68-FSC-GRY	Gray	Non-metallic carpet plate and cover with 1" NPS screw plug	4
P-68-FSC-BRN	Brown	Non-metallic carpet plate and cover with 1" NPS screw plug	4

New MopTite® Covers exceed UL watertight requirements for 514A, 514C.

CAT. NO.	COLOR	DESCRIPTION	STD. CTN.
P-68-FSC-BGE	Beige	Non-metallic carpet plate and cover with 1" NPS screw plug	4
P-68-FSC-BLK	Black	Non-metallic carpet plate and cover with 1" NPS screw plug	4
P-68-DRC-GRY	Gray	Non-metallic carpet plate and cover for duplex receptacle	4
P-68-DRC-BRN	Brown	Non-metallic carpet plate and cover for duplex receptacle	4
P-68-DRC-BGE	Beige	Non-metallic carpet plate and cover for duplex receptacle	4
P-68-DRC-BLK	Black	Non-metallic carpet plate and cover for duplex receptacle	4

New MopTite® Covers exceed UL watertight requirements for 514A, 514C.



MopTite® Metallic Cover Plates for 68-P Series

- Brushed finish
- Furnished complete with sealing gasket and 8-32 x 7/16" brass screws
- 4" outside diameter
- For brushed aluminum, add AL after catalog number

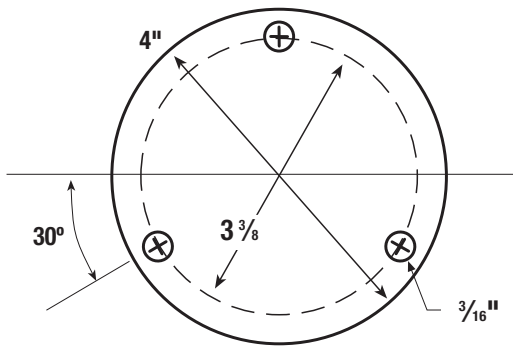

* Also includes steel seating plate for receptacles.



CAT. NO.	DESCRIPTION	STD. CTN.
P-60-1/2	Brass cover plate 1/2" NPS plug size	4
P-60-1/2-AL	Aluminum cover plate 1/2" NPS plug size	4
P-60-3/4	Brass cover plate 3/4" NPS plug size	4
P-60-3/4-AL	Aluminum cover plate 3/4" NPS plug size	4
P-60-1	Brass cover plate 1" NPS plug size	4
P-60-1-AL	Aluminum cover plate 1" NPS plug size	4
P-60-1-1/4	Brass cover plate 1 1/4" NPS plug size	4
P-60-1-1/4-AL	Aluminum cover plate 1 1/4" NPS plug size	4
P-60-2	Brass cover plate 2" diameter plug size	4
P-60-2-AL	Aluminum cover plate 2" diameter plug size	4
P-60-2-5/8	Brass cover plate 2 5/8" diameter plug size	4
P-60-2-5/8-AL	Aluminum cover plate 2 5/8" diameter plug size	4
P-60-1/2-2	Brass cover plate 1/2"-2" diameter plug size	4
P-60-1/2-2-AL	Aluminum cover plate 1/2"-2" diameter plug size	4
P-60-3/4-2	Brass cover plate 3/4"-2" diameter plug size	4
P-60-3/4-2-AL	Aluminum cover plate 3/4"-2" diameter plug size	4
P-60-DR	Brass cover with duplex lift lid	4
P-60-DR-AL	Aluminum cover with duplex lift lid	4
P-60-DS	Brass cover for duplex with individual lift lids	4
P-60-DS-AL	Aluminum cover for duplex with individual lift lids	4
P-60-DU	Brass cover plate with two 1 7/16" plugs for duplex	4
P-60-DU-AL	Aluminum cover with two 1 7/16" plugs for duplex	4
P-60-GFCI	Brass cover plate for GFCI devices	4
P-60-GFCI-AL	Aluminum cover plate for GFCI devices	4

68P-FL or 68P-FL-AL required to attach cover plates to 68-P floor box.

New MopTite® Covers exceed UL watertight requirements for 514A, 514C.



P-60-1/2
1/2" N.P.S. Plug Size

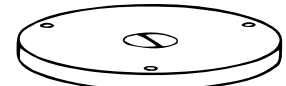

P-60-3/4
3/4" N.P.S. Plug Size

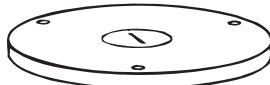

P-60-1
1" N.P.S. Plug Size

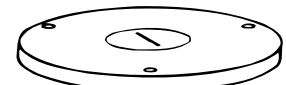

P-60-1-1/4
1 1/4" N.P.S. Plug Size

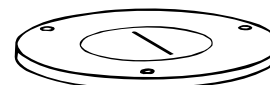

P-60-2*
2" dia. Plug Size



P-60-2-5/8*
2 5/8" dia. Plug Size

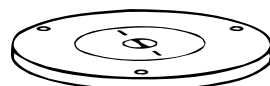

P-60-1/2-2*
1/2" & 2" dia. Plug Size



P-60-3/4-2*
3/4" & 2" dia. Plug Size



P-60-DR*
Duplex Lift Lid

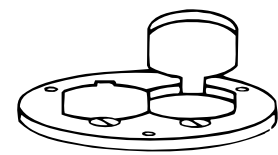

P-60-DS*
Hinged Lift Lids



P-60-DU*
Duplex 1 7/16" Plugs

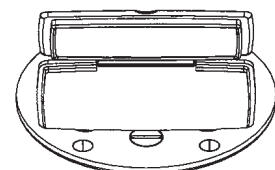

P-60-GFCI*

NEW!

68R Recessed Covers

Plug in power and communication cords, and then close the lid to hide unsightly plugs and receptacles below the floor!

- Unique cover provides aesthetic recessed service with cost-effective box options for concrete, wood sub-floor and raised floor applications
- Patented lid can be rotated to expose a small opening for cords, enabling the lid to close flush with the floor while in use
- Cover accepts one duplex or GFCI receptacle — no special device plates required (receptacle purchased separately)
- Cover accepts up to two communications jacks — includes one 2-port keystone data plate and one blank data plate for custom cut-outs or power-only applications (communications jacks purchased separately)
- Non-metallic covers are available in black, gray, beige and brown. Black covers are available with an optional brass or aluminum flange.
- Two set screws lock the cover in place — no gluing required



Concrete applications



Wood sub-floor/raised floor applications



Use a Steel City Round PVC Floor Box, catalog number 68-P (purchased separately)



Use an appropriate Steel City 3" x 2" Metal Switch Box with mounting ears (purchased separately).



Lid closes flush with the floor, even with cords plugged in.

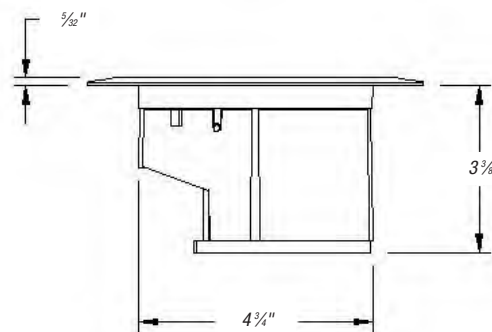
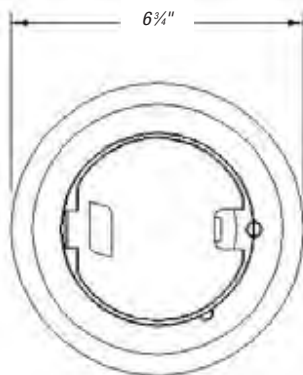



68R Recessed Covers (continued)

Cover kit includes:

- Cover assembly
- Receptacle mounting plate
- Duplex receptacle insert
- 2-port keystone data plate
- Blank data plate
- Voltage divider



Power and Communications.

Technical Information



Important Application Note:

When using the 68R Recessed Cover with the 68-P floor box for concrete applications, the entire box depth (6") is required. Prior to concrete pour, level the top of the box with the screed line of the concrete.

CAT. NO.	DESCRIPTION	STD. CTN.
68R-CST-BLK	Non-metallic recessed floor box cover kit, black	4
68R-CST-GRY	Non-metallic recessed floor box cover kit, gray	4
68R-CST-BGE	Non-metallic recessed floor box cover kit, beige	4
68R-CST-BRN	Non-metallic recessed floor box cover kit, brown	4
68R-CST-BRS	Non-metallic recessed floor box cover kit, black with brass flange	4
68R-CST-ALM	Non-metallic recessed floor box cover kit, black with aluminum flange	4
68-P	Round PVC floor box for concrete applications	8
CXWOW*	3" x 2" metal switch box, 3/2" deep, for non-metallic sheathed cable	25
CY 1/2*	3" x 2" metal switch box, 3/2" deep, 1/2" KOs	25